



Tool & Equipment Warehouse Inc.

TM

# MECHANIC'S TOOL CLUB™



PG. 3



PG. 39



PG. 7



PG. 11



PG. 45



PG. 49



PG. 54

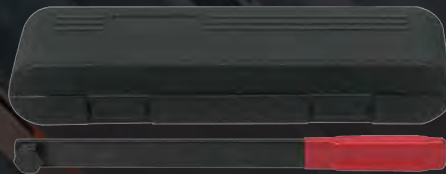

PG. 79



SINCE 1983

# GEARWRENCH

AIR TOOLS

BOOSTERS

BODY TOOLS

DIAGNOSTIC

HAND TOOLS

SPECIALITY TOOLS

TOOL BOXES

TRUCK EQUIPMENT

# MECHANIC'S TOOL CLUB™

## JOIN THE CLUB & SAVE!

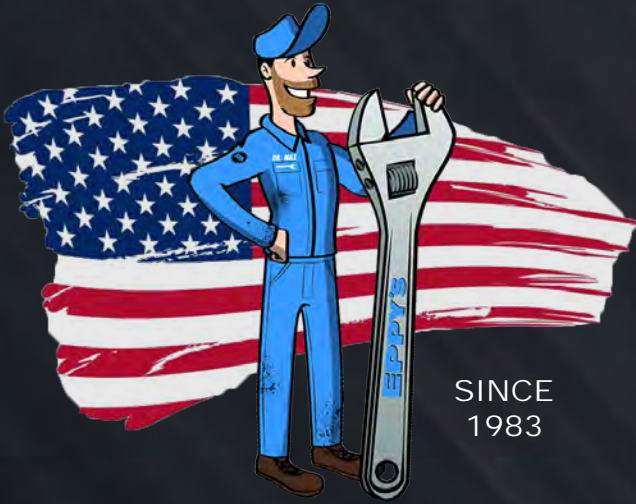

### CLUB MEMBER

\$12.00 ANNUAL FEE  
SAVE 20% FOR ONE YEAR

### LIFE MEMBER

\$60.00 ONE-TIME FEE  
SAVE 22% FOREVER

Eppy's offers two types of memberships with everyday savings. Not a member? No problem. We offer a broad range of Automotive Tool & Equipment to all! Stop by our NY or NJ location or shop at [www.eppys.com](http://www.eppys.com) to view 100+ brands and 100,000+ products!

- ✓ FAST DELIVERY
- ✓ COMPETITIVELY PRICED
- ✓ NY / NJ SHOWROOMS & WAREHOUSE
- ✓ QUALITY SERVICE
- ✓ WARRANTY ASSISTANCE
- ✓ FACTORY AUTHORIZED DISTRIBUTOR



### NEW SHIPPING POLICY

#### \$15 FLAT-FEE RATE

On All Orders Less Than 20lbs.  
Some exclusions may apply.

### ORDERS SHIP OUT DAILY

On Orders placed before 2PM EST  
Via UPS, USPS, or Truck Freight

### FREE DELIVERY

Orders \$200.00 + and within a 20 mile radius from NY or NJ store location.  
Some exclusions may apply.

**WE'RE HIRING!**

Looking for a new career? We're hiring! Send your resume to [tools@eppys.com](mailto:tools@eppys.com)

## NEW YORK

809 EAST 42ND ST  
BROOKLYN, NY 11210  
BTWN GLENWOOD RD & FARRAGUT RD

TEL: 718-434-7878  
FAX: 718-434-9317  
SALES@EPPYS.COM

MONDAY - FRIDAY 8:00 AM - 6:00 PM  
SATURDAY 9:00 AM - 4:00 PM  
SUNDAY CLOSED

## NEW JERSEY

2777 ROUTE 9 N  
HOWELL, NJ 07731  
JUST NORTH OF INTERSTATE 195

TEL: 732-942-3700  
FAX: 732-942-3707  
SALES@EPPYS.COM

MONDAY CLOSED  
TUESDAY - FRIDAY 9:00 AM - 6:00 PM  
SATURDAY 9:00 AM - 4:00 PM  
SUNDAY 10:00 AM - 4:00 PM

Due to the ongoing material inflation some catalog prices are subject to change before 3/31/2023. Some quantities limited.



# RATCHETING WRENCHES

WRENCHES

KDT86727  
12pc 12PT  
Ratcheting  
**METRIC**  
Flex-Head  
Wrench Set  
Sizes: 8mm - 19mm  
Sale \$249.94  
**Tool Club \$199.<sup>95</sup>**



KDT86928  
16pc 12PT  
Ratcheting  
**METRIC**  
Wrench Set  
Sizes: 8mm - 19mm  
21mm - 25mm  
Sale \$249.94  
**Tool Club \$199.<sup>95</sup>**



**NEW!** **GW** **GEARWRENCH**

KDT86758  
10pc 12PT  
Ratcheting  
**SAE** Flex-Head  
Wrench Set  
Sizes: 1/4" - 3/4"  
Sale \$187.44  
**Tool Club \$149.<sup>95</sup>**



KDT86959  
14pc 12PT **SAE**  
Ratcheting  
Wrench Set  
Sizes: 1/4" - 1"  
Sale \$224.94  
**Tool Club \$179.<sup>95</sup>**



**EZRNR5M**  
5pc Ratcheting **METRIC**  
**X-Long Flex Head Wrench Set**  
8mm x 10mm, 12mm x 14mm, 13mm x  
15mm, 16mm x 18mm & 17mm x 19mm  
Sale \$218.13 **Tool Club \$174.<sup>50</sup>**



**EZRWR5ML**  
5pc Ratcheting **METRIC** Extra  
**Long Locking Flex Head Wrench Set**  
8mm x 10mm, 12mm x 14mm,  
13mm x 15mm, 16mm x 18mm  
& 17mm x 19mm  
Sale \$262.44 **Tool Club \$209.<sup>95</sup>**



KDT9416  
16pc Ratcheting Master **METRIC**  
Sizes: 8 to 24mm.  
Sale \$224.94  
**Tool Club \$179.<sup>95</sup>**



KDT9901D  
12pc Ratcheting **METRIC** Flex  
Sizes: 8 to 19mm.  
Sale \$249.94  
**Tool Club \$199.<sup>95</sup>**



KDT9412  
12pc Ratcheting **METRIC** Set  
Sizes: 8 to 19mm.  
Sale \$129.94  
**Tool Club \$103.<sup>95</sup>**



KDT86126  
10pc Ratcheting **METRIC**  
**XL Flex Gearbox Wrench Set**  
Sizes: 10 - 19mm.  
Sale \$337.44 **Tool Club \$269.<sup>95</sup>**



KDT9312  
12pc Ratcheting Master **SAE**  
Sizes: 1/4" to 1".  
Sale \$199.94  
**Tool Club \$159.<sup>95</sup>**



KDT9701  
8pc Ratcheting **SAE** Flex  
Sizes: 5/16" to 3/4".  
Sale \$237.44  
**Tool Club \$189.<sup>95</sup>**



KDT9308D  
8pc Ratcheting **SAE** Wrench Set  
Sizes: 5/16" - 3/4".  
Sale \$137.44  
**Tool Club \$109.<sup>95</sup>**

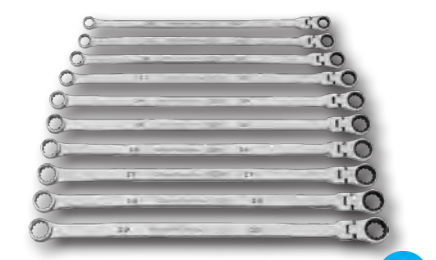

KDT86142  
10pc Ratcheting **SAE** XL Flex  
Gearbox Wrench Set  
Sizes: 1/4" - 3/4".  
Sale \$312.44 **Tool Club \$249.<sup>95</sup>**

## X-FRAME RATCHETING WRENCHES

See it in action!



Scan QR Code



SKT80019  
12pc **METRIC**  
Sizes: 8 to 19mm.  
Sale \$299.94 **Tool Club \$239.<sup>95</sup>**



SKT80049  
7pc **SAE**  
Sizes: 3/8" - 3/4".  
Sale \$187.44 **Tool Club \$149.<sup>95</sup>**

**SK**  
PROFESSIONAL TOOLS



Features:

- 1.7° arc swing - lowest in the industry!
- 216 ratcheting positions
- 5x ANSI spec for torque
- I-Beam handle distributes force evenly
- SureGrip open end design
- LIFETIME WARRANTY

**METRIC CROWFOOT WRENCHES**

**SUN9710M**  
**10pc METRIC**  
**Flare Nut**  
 Sizes: 10 - 19mm  
 Sale \$45.94  
**Tool Club \$36.75**



**KDT81909**  
**10pc METRIC**  
 Sizes: 10 - 19mm  
 Sale \$96.19  
**Tool Club \$76.95**



**THEY RATCHET!**  
**KDT89119**  
**10pc Ratcheting**  
**METRIC**  
 Sizes: 10 to 19mm  
 Sale \$124.94  
**Tool Club \$99.95**



**SUN9730**  
**8pc METRIC**  
**Jumbo Sizes:**  
 24, 25, 26,  
 27, 28, 29, 30  
 & 32mm.  
 Sale \$80.63  
**Tool Club \$64.50**



**SUN9740**  
**7pc METRIC**  
**Jumbo Sizes:**  
 34, 35, 36, 38,  
 41, 42, & 46mm.  
 Sale \$114.06  
**Tool Club \$91.25**



**WILW1086**  
**8pc METRIC Offset Box Wrench Set**  
 Sizes: 6mm - 22mm.  
 Sale \$27.44 **Tool Club \$21.95**



**WILW1085**  
**8pc SAE Offset Box Wrench Set**  
 Sizes: 1/4 - 7/8".  
 Sale \$27.44 **Tool Club \$21.95**

**SAE CROWFOOT WRENCHES**

**SUN9708** **SUNEX TOOLS**  
**8pc SAE**  
 Sizes: 3/8" to 7/8"  
 Sale \$35.63  
**Tool Club \$28.50**



**KDT81908**  
**11pc SAE**  
 Sizes: 3/8", 7/16",  
 1/2", 9/16", 5/8",  
 11/16", 3/4",  
 13/16", 7/8",  
 15/16" & 1".  
 Sale \$106.19  
**Tool Club \$84.95**



**SUN9721**  
**14pc SAE**  
**Jumbo**  
**Crowfoot**  
 1-1/16", 1-1/8",  
 1-3/16", 1-1/4",  
 1-5/16" & 1-3/8", 1-7/16", 1-1/2", 1-5/8",  
 1-11/16", 1-3/4", 1-13/16", 1-7/8", 2".  
 Sale \$134.94  
**Tool Club \$107.95**



**SUN9720**  
**7pc SAE**  
**Jumbo Sizes:**  
 1", 1-1/16", 1-1/8",  
 1-3/16", 1-1/4",  
 1-3/8" & 1-1/2".  
 All 1/2" drive.  
 Sale \$82.44  
**Tool Club \$65.95**



**SUN9722**  
**6pc SAE**  
**Jumbo Sizes:**  
 1-5/8", 1-3/4",  
 1-7/8", 2",  
 2-1/8" & 2-1/4".  
 All 1/2" drive.  
 Sale \$127.19  
**Tool Club \$101.75**



**FLARENUT WRENCHES**

**KDT81911D**  
**6pc METRIC**  
**Swivel Flare Nut**  
 Sizes: 9-19 & 21mm.  
 Sale \$162.44  
**Tool Club \$129.95**

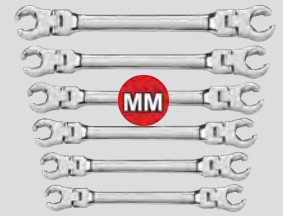

**KDT81910**  
**5pc SAE**  
**Swivel Flare Nut**  
 With flex heads.  
 Sizes: 1/4", 5/16", 3/8",  
 7/16", 1/2", 9/16", 5/8",  
 11/16", 3/4", & 13/16".  
 Sale \$137.44  
**Tool Club \$109.95**



**SUN9809** **SUNEX TOOLS**  
**9pc SAE & METRIC**  
**Flare Nut Wrench Set**  
 SAE: 1/4" to 11/16"  
 METRIC: 8, 9, 10, 12, 13,  
 14, 15, 17, 19 & 21mm.  
 Sale \$56.25  
**Tool Club \$45.00**



**SUN910MTAS** **SUNEX TOOLS** **NEW!**  
**10pc 3/8" Dr. METRIC Torque Adapter Set**  
 Sizes: 10mm - 19mm. 2" long. 12 Point.  
 Sale \$102.81 **Tool Club \$82.25**



**SUN909TAS** **SUNEX TOOLS** **NEW!**  
**9pc 3/8" Dr. SAE Torque Adapter Set**  
 Sizes: 1/4" - 3/4". 2" long. 12 Point.  
 Sale \$96.19 **Tool Club \$76.95**

**THIN WRENCHES**

**WILW30683** **SAE**  
**7pc SAE Super Thin Wrench Set**  
 Sizes: 3/8" - 1-1/4"  
 Sale \$47.81 **Tool Club \$38.25**



**WILW30684** **MM**  
**7pc METRIC Super Thin Wrench Set**  
 Sizes: 8mm - 32mm  
 Sale \$47.81 **Tool Club \$38.25**



**VIMSFW100** **SAE**  
**4pc SAE Flat Wrench Set**  
 Sizes: 1/4" - 3/4". Long length,  
 extended reach. Super thin for limited access.  
 Sale \$54.94 **Tool Club \$43.95**



**VIMMFW100** **SAE**  
**7pc Metric Flat Wrench Set**  
 Sizes: 6mm - 19mm. Long length,  
 extended reach. Super thin for limited access.  
 Sale \$80.63 **Tool Club \$64.50**



# METRIC & SAE (INCH) WRENCH SETS

## COMBINATION

**SUNEX**  
TOOLS

**SUN9605M**  
5pc **METRIC**  
Large Sizes  
Sizes: 20 to 24mm  
Sale \$43.13  
**Tool Club \$34.50**



**SUN9606M**  
6pc **METRIC**  
Large Sizes  
Sizes: 25, 26, 27,  
29, 30 & 32mm  
Sale \$80.44  
**Tool Club \$64.35**



**SUN9707M**  
7pc **METRIC**  
Jumbo Sizes  
Sizes:  
33, 34, 36,  
38, 41, 46 & 50mm  
Sale \$178.69  
**Tool Club \$142.95**



**SUNEX**  
TOOLS

**SUN9715**  
14pc **METRIC**  
Raised Panel  
Wrench Set  
Sizes: 6 to 19mm  
Sale \$63.44  
**Tool Club \$50.75**



**SUN9707**  
7pc **SAE**  
JUMBO SIZES  
Wrench Set  
Sizes:  
1-5/16", 1-3/8",  
1-1/2", 1-5/8",  
1-3/4", 1-7/8" & 2"  
Sale \$167.44  
**Tool Club \$133.95**



**SUN9714**  
14pc **SAE**  
Wrench Set  
Sizes: 3/8", 7/16", 1/2",  
9/16", 5/8", 11/16", 3/4",  
13/16", 7/8", 15/16", 1",  
1-1/16", 1-1/8" & 1-1/4"  
Sale \$86.56  
**Tool Club \$69.25**



**SUN9915**  
14pc **SAE**  
Long Pattern  
Sizes: 3/8",  
7/16", 1/2", 9/16",  
5/8", 11/16", 3/4", 13/16",  
7/8", 15/16", 1", 1-1/16",  
1-1/8" & 1-1/4"  
Sale \$103.75  
**Tool Club \$83.00**



## LONG PATTERN

**SUN9918M**  
5pc **METRIC**  
Long Pattern  
Sizes: 20 to 24mm  
Sale \$59.69  
**Tool Club \$47.75**



**SUN9917M**  
12pc **METRIC**  
Long Pattern  
Sizes: 8 to 19mm  
Sale \$59.69  
**Tool Club \$47.75**



## STUBBY WRENCHES

**SUN9930M**  
11pc **METRIC**  
Sizes: 10 to 19mm  
Sale \$47.81  
**Tool Club \$38.25**



**SUN9930**  
10pc **SAE** Stubby Set  
Sizes: 3/8", 7/16", 1/2",  
9/16", 5/8", 11/16",  
3/4", 13/16", 7/8" & 1"  
Sale \$59.06  
**Tool Club \$47.25**



## HALF MOON BOX

**SUN9935M**  
5pc **METRIC** Half Moon Wrench Set  
Sizes: 8 - 22mm  
Sale \$43.13 **Tool Club \$34.50**



**SUN9935**  
5pc **SAE** Half Moon Wrench Set  
Sizes: 5/16" to 7/8"  
Sale \$43.13 **Tool Club \$34.50**



## V-GROOVE

**SUN9917MPRA**  
25pc **METRIC** V-Groove  
Wrench Set  
Sizes: 8 - 32mm  
Sale \$237.44  
**Tool Club \$189.95**



**SUN9919MA**  
8pc **METRIC** V-Groove  
Wrench Set  
Sizes: 8 - 32mm  
Sale \$137.44 **Tool Club \$109.95**



## ANGLED HEAD OPEN END

**SUN9914**  
14pc **SAE**  
Sizes: 3/8",  
7/16", 1/2",  
9/16", 5/8",  
11/16", 3/4",  
13/16", 7/8",  
15/16", 1", 1-1/16",  
1-1/8" & 1-1/4"  
Sale \$100.94  
**Tool Club \$80.75**



**SUN9916**  
6pc **SAE**  
JUMBO  
SIZES:  
1-3/8", 1-1/2",  
1-5/8", 1-3/4",  
1-7/8" & 2"  
Sale \$183.13  
**Tool Club \$146.50**



**SUN9926**  
6pc **METRIC**  
JUMBO Wrench Set  
Sizes: 20, 21, 22,  
23, 24, 25mm.  
Sale \$60.63  
**Tool Club \$48.50**



**SUN9927**  
7pc **METRIC**  
JUMBO  
Wrench Set  
Sizes: 26, 27,  
28, 29, 30, 31,  
32mm.  
Sale \$110.94  
**Tool Club \$88.75**



**VIMWE15**  
15" Wrench Extender  
Sale \$58.69 **Tool Club \$46.95**

**NEW!**

## SUNEX<sup>®</sup> TOOLS 12 POINT

## JUMBO SAE

**SUN97010**  
10pc **SAE** JUMBO  
Combination Wrench Set  
• Raised panel design  
• Forged from high quality carbon steel  
• Meets or exceeds ANSI specs  
• Includes canvas pouch  
• Lifetime Warranty  
• Sizes: 1-5/16", 1-3/8", 1-7/16", 1-1/2",  
1-5/8", 1-11/16", 1-3/4", 1-7/8", 1-13/16", 2"  
Sale \$274.06 **Tool Club \$219.25**



**SUN9604**  
4pc **SAE** JUMBO Combination Wrench Set  
• Raised panel design  
• Forged from high quality carbon steel  
• Meets or exceeds ANSI specs  
• Includes canvas pouch  
• Lifetime Warranty  
• Sizes: 2-1/8", 2-3/8", 2-1/4", 2-1/2"  
Sale \$288.69 **Tool Club \$230.95**



**IRT752017**  
**66pc 1/4" Dr.**  
**SAE/Metric Master Mechanics Tool Set**  
 1/4" Dr. ratchet, 6" extension, SAE Short & Deep: 3/16" - 1/2". Metric Short: 4mm - 12mm; Deep: 4mm - 13mm.  
 Sale \$99.94 **Tool Club \$79.95**



**IRT752018**  
**68pc 3/8" Dr.**  
**SAE/Metric Master Mechanics Tool Set**  
 3/8" Dr. 72 tooth sealed head ratchet, 3" & 6" extensions, U-Joint & bit adapter.  
 6PT SAE Short: 3/8" - 7/8"; Deep: 3/8" - 7/8"  
 12PT Metric Short: 8mm - 19mm.  
 6PT Metric Deep: 8mm - 19mm.  
 Sale \$112.44 **Tool Club \$89.95**



**IRT752020**  
**101pc SAE/Metric Master Mechanics Tool Set**  
 1/4", 3/8", 1/2", Drive Tools, Metric & SAE Short & Deep, Hex Bit Sockets, Tamper-Proof Torx extensions, U-Joint  
 Sale \$179.94 **Tool Club \$143.95**



**IRT752000**  
**47pc 1/4" Dr.**  
**SAE/METRIC Socket & Accessory Set**  
 1/4" Dr. ratchet, 3 in. and 6 in. extensions, 6PT SAE Short: 5/32" - 1/2". 6PT SAE Deep: 5/32" - 1/2". 6PT Metric Short: 4, 4.5, 5, 5.5, 6 - 13mm 6PT Metric Deep: 4, 5, 5.5, 6 - 13mm  
 Sale \$134.94 **Tool Club \$107.95**



**IRT752001**  
**49pc 3/8" Dr. SAE/METRIC Master Socket & Accessory Set**  
 3/8" Dr. ratchet, 3", 6" & 10" extensions 12PT SAE Short: 3/8" - 7/8". 6PT SAE Deep: 3/8" - 7/8". 12PT Metric Short: 8mm - 19mm. 6PT Metric Deep: 8mm - 19mm.  
 Sale \$174.94 **Tool Club \$139.95**



**IRT752002**  
**54pc 1/2" Dr. SAE/METRIC Master Socket & Accessory Set**  
 1/2" Dr. 90 tooth sealed head ratchet, 17" flex handle, 5" & 10" extensions & U-Joint. 12PT SAE Short: 9/16" - 1-1/4". 6PT SAE Deep: 9/16" - 1-1/8". 12PT Metric Short: 14mm - 27mm, 30mm. 6PT Metric Deep: 14mm - 24mm.  
 Sale \$268.69 **Tool Club \$214.95**

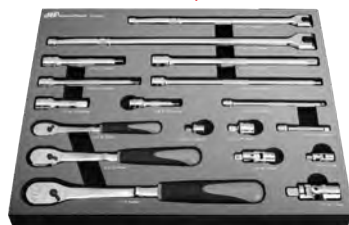

**IRT752025**  
**19pc Master Ratchet & Socket Accessory Kit**  
 1/4", 3/8" & 1/2" Dr. Ratchets. 1/4" Dr.: 3" & 6" extensions, & U-Joint. 3/8" Dr.: 10" flex handle, 3", 6", & 10" extensions, U-Joint & 3/8" F x 1/4" M adapter. 1/2" Dr.: 17" flex handle, 3", 5" & 10" extensions, U-Joint & 1/2" F x 3/8" M adapter. Includes laser-cut foam organizer tray.  
 Sale \$247.44 **Tool Club \$197.95**



**IRT752057**  
**11pc Long Pattern Metric Set**  
 Sizes: 8, 10, 11, 12, 13, 14, 15, 16, 17, 18 & 19mm  
 Sale \$89.94 **Tool Club \$71.95**

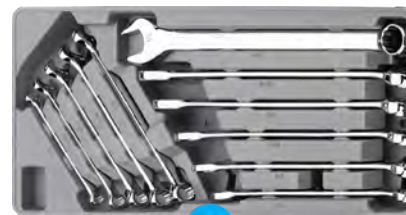

**IRT752058**  
**16pc Long Pattern SAE Set**  
 Sizes: 1/4, 5/16, 3/8, 7/19, 1/2, 9/16, 5/8, 11/16, 3/4, 13/16 & 7/8"  
 Sale \$89.94 **Tool Club \$71.95**



**IRT752003**  
**66pc Master Torx & Specialty Bit Socket Set**  
 E-Torx, Tamper-Proof, Torx Long Reach 4" 3/8" Dr. Hex Sockets, SAE & Metric 4" Long Hex Sockets, Triple Square XZN Sockets  
 Sale \$224.94 **Tool Club \$179.95**

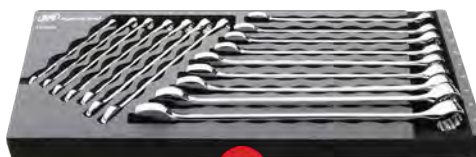

**IRT752009**  
**16pc Master Metric Set**  
 Sizes: 6, 7, 8, 9, 10, 11, 12, 13, 14, 15, 16, 17, 18, 19, 21, & 22mm  
 Sale \$174.94 **Tool Club \$139.95**

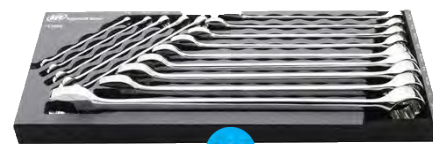

**IRT752008**  
**14pc Tech Solutions Master Non-Slip Combination Wrench Set - SAE**  
 1/4, 5/16, 3/8, 7/16, 1/2, 9/16, 5/8, 11/16, 3/4, 13/16, 7/8, 15/16, 1, 1-1/8  
 Sale \$174.94 **Tool Club \$139.95**





**KDT80300**  
**51pc 1/4" Drive SAE & Metric**  
 Short: 3/16" - 9/16"; 4 - 15mm  
 Deep: 3/16" - 9/16"; 4 - 15mm  
 Ratchet, Thumbwheel, U-Joint,  
 2" & 5" extensions.



Sale \$131.19 **Tool Club \$104.95**



**KDT80550**  
**57pc 3/8" Drive SAE & Metric**  
 Short: 1/4" - 1"; 4 - 19mm  
 Deep: 1/4" - 7/8"; 4 - 19mm  
 Regular & Stubby Ratchets,  
 U-Joint, 3" & 6" extensions.



Sale \$181.19 **Tool Club \$144.95**



**KDT80700D**  
**49pc 1/2" Drive SAE & Metric**  
 Short: 7/16" - 1-1/8"; 10 - 24mm  
 Deep: 1/2" - 15/16"; 4 - 19mm  
 Ratchet, U-Joint,  
 3" & 5" extensions.



Sale \$274.94 **Tool Club \$219.95**



**KDT80942**  
**219pc Mechanic's Tool Set**  
 1/4", 3/8" & 1/2" Drive, 6 & 12 PT **SAE & Metric.**  
 Includes ratchets, drivers, wrenches,  
 extensions and allen keys.



Sale \$474.94 **Tool Club \$379.95**



**KDT80940**  
**215pc Mechanic's Tool Set**  
 1/4", 3/8" & 1/2" Drive, 6 & 12 PT **SAE & Metric.**  
 Includes ratchets, drivers, wrenches,  
 extensions and allen keys.



Sale \$399.94 **Tool Club \$319.95**



**KDT80966**  
**243pc Mechanic's Tool Set**  
 1/4", 3/8" & 1/2" Dr. 6PT **SAE & Metric.**  
 Includes short & 1/4" & 3/8" Dr.  
 Deep Sockets, ratchets, wrenches,  
 torx, extensions, bit driver w/ bits!



Sale \$524.94 **Tool Club \$419.95**



**KDT86529**  
**83pc 1/4", 3/8", 1/2" 90-Tooth SAE & Metric**  
**Mechanics Tool Set with EVA Foam Tray**  
 90-tooth gear delivers a 4° swing arc to turn a  
 fastener in tight confines. 6pt full polish chrome  
**SAE & Metric** 1/4, 3/8" and 1/2" standard  
 sockets featuring off-corner loading design to  
 reduce fastener rounding.



Sale \$374.94 **Tool Club \$299.95**



**KDT86521**  
**21pc 3/8" 90-Tooth Ratchet &**  
**Drive Tool Set with EVA Foam Tray**  
 Locking extension bars, Gimbal ratchet,  
 Thumbwheel ratchet. Ultimate assortment of 3/8"  
 drive tools including ratchets, adapters, universal  
 joint and extension bars. 90-tooth gear delivers a  
 4° swing arc to turn a fastener in tight confines.  
 EVA Foam tray size: 21.5" x 13.46" x 2.0"



Sale \$287.44 **Tool Club \$229.95**



**AUT43052**  
**52pc Socket Set**  
 Emergency travel set for DIY users.

- 2 ratchets 3/8 & 1/2, Adapters and bits
- 1/4in Dr. 6 pt. socket metric: 4 to 13mm
- 1/4in Dr. 8 pt. socket SAE: 1/4, 5/16, and 3/8in
- 1/4in Dr. 6 pt. socket SAE: 5/32 to 1/2in
- 3/8in Dr. 6 pt. socket Metric: 11, 12 and 13mm
- 3/8in Dr. 6 pt. socket SAE: 9/16, 1/2, and 11/16in
- 1/2in Dr. 6 pt. socket SAE: 5/8, 11/16, 3/4, & 13/16in



**CTA1189**  
**17pc Deep Metric Socket Set**  
 Sizes: 6mm - 21mm. Sockets are 120mm long  
 & deep broched for extra-deep reach. Provides  
 access to recessed areas with extra long bolts, as  
 found on some bumpers, rear lamps, glow plugs &  
 door ginge fittings. Sockets are 3/8" & 1/2" drive.  
 Includes 1/2"Fx3/8"M & 3/8"Fx1/4"M adapters.



Sale \$237.44 **Tool Club \$189.95**

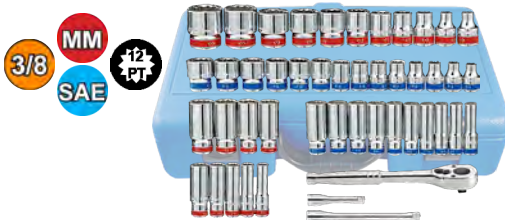

**KTA3005CR**  
**47pc 12PT 3/8" Dr. SAE & Metric Socket Set**  
 Short SAE Sizes: 1/4" - 7/8"  
 Short Metric Sizes: 6mm - 19mm  
 Deep SAE Sizes: 3/8" - 7/8"  
 Deep Metric Sizes: 10mm - 19mm  
 Reversible 8" Ratchet  
 3" & 6" Extensions



Sale \$124.99 **Tool Club \$99.99**

**CTA10100**  
**69pc 3/8" Dr. Euro-Metric**  
**Tool Set**

Short: 6mm - 24mm;  
 Deep: 5mm - 21mm;  
 Hex Bits: 3mm - 10mm;  
 E-Torx: E5 - E20;  
 T-Torx: T10 - T60;  
 3/8" Dr. Ratchet,  
 6" & 10" extensions,  
 U-Joint, and  
 1/2" F x 3/8" M drive  
 adapter with breaker bar hole.



Sale \$143.69 **Tool Club \$114.95**

**MASTER SETS**



**SKT91848**  
**48pc 1/4" Drive SAE & Metric**  
 Short: 3/16" - 9/16"; 4 - 15mm  
 Deep: 1/4" - 9/16"; 6 - 15mm  
 Ratchet, 2 adapters, Thumbwheel, U-Joint, & 2 Extensions  
 Sale \$262.44 **Tool Club \$209.95**



**SKT91860**  
**60pc 1/4" Drive SAE & Metric**  
 Short: 1/8" - 5/8"; 4 - 16mm  
 Deep: 1/8" - 9/16"; 4 - 15mm  
 Ratchet, 2 adapters, U-Joint, & 2 Extensions  
 Sale \$374.94 **Tool Club \$299.95**



**SKT94562**  
**41pc 1/4" Drive Metric**  
**1/4" Drive**  
 Short: 4 - 15mm; Deep: 5.5-15mm  
 Ratchet, Extensions, & Adapter  
**3/8" Drive**  
 Short: 6 - 22mm; Deep: 8 - 19mm  
 Ratchet, Extensions, & Adapter, & U-Joint  
 Sale \$387.44 **Tool Club \$309.95**



**SKT4147**  
**47pc 1/2" Drive SAE & Metric**  
 Short: 1/2" - 1-1/8"; 10 - 24mm  
 Deep: 1/2" - 15/16"; 10 - 19mm  
 Ratchet, 2" & 5" extensions  
 Sale \$499.94 **Tool Club \$399.95**



**SKT4147-6**  
**47pc 1/2" Drive SAE & Metric**  
 Short: 1/2" - 1-1/8"; 10 - 24mm  
 Deep: 1/2" - 15/16"; 10 - 19mm  
 Ratchet, 2" & 5" extensions  
 Sale \$499.94 **Tool Club \$399.95**



**SKT94549**  
**49pc 3/8" Drive SAE & Metric**  
 Short: 1/4" - 7/8"; 6 - 19mm  
 Deep: 3/8" - 7/8"; 10 - 19mm  
 Ratchet, Thumbwheel, U-Joint, & 2 extensions  
 Sale \$299.94 **Tool Club \$239.95**

**SK 1/4" DRIVE**

**SK 3/8" DRIVE**

**SK 1/2" DRIVE**

**SKT1312**  
**13pc 1/4" Dr. METRIC Deep Set**  
 Sizes: 4, 5, 5.5, 6, 7, 8, 9, 10, 11, 12, 13, 14 & 15mm  
 Sale \$146.88 **Tool Club \$117.50**

**SKT1313**  
**13pc 1/4" Dr. METRIC Short Set**  
 Sizes: 4, 5, 5.5, 6, 7, 8, 9, 10, 11, 12, 13, 14 & 15mm  
 Sale \$90.44 **Tool Club \$72.35**

**SKT1340**  
**10pc 1/4" Dr. METRIC Short Set**  
 Sizes: 5, 6, 7, 8, 9, 10, 11, 12, 13 & 14mm.  
 Sale \$65.31 **Tool Club \$52.25**

**SKT4910**  
**10pc 1/4" Dr. SAE Short Set**  
 Sizes: 3/16" to 9/16".  
 Sale \$62.44 **Tool Club \$49.95**

**SKT4911**  
**10pc 1/4" Dr. SAE Deep Set**  
 Sizes: 3/16" to 9/16".  
 Sale \$112.44 **Tool Club \$89.95**

**SKT133**  
**13pc 3/8" Dr. METRIC Short Set**  
 Sizes: 7 - 19mm.  
 Sale \$111.19 **Tool Club \$88.95**

**SKT89023**  
**13pc 3/8" Dr. 12PT METRIC Short Set**  
 Sale \$81.19 **Tool Club \$64.95**

**SKT1854**  
**14pc 3/8" Dr. METRIC Deep Set**  
 Sizes: 6 - 19mm.  
 Sale \$174.06 **Tool Club \$139.25**

**SKT1871**  
**11pc 3/8" Dr. METRIC Deep Set**  
 Sizes: 9 - 19mm.  
 Sale \$139.06 **Tool Club \$111.25**

**SKT4613**  
**13pc 3/8" Dr. SAE Short Set**  
 Sizes: 1/4" to 1".  
 Sale \$116.88 **Tool Club \$93.50**

**SKT4413**  
**13pc 3/8" Dr. SAE Deep Set**  
 Sizes: 1/4" to 1".  
 Sale \$162.44 **Tool Club \$129.95**

**SKT1924**  
**24pc 1/2" Dr. METRIC Short Set**  
 Sizes: 10 - 32 & 36mm  
 Sale \$343.69 **Tool Club \$274.95**

**SKT1945**  
**15pc 1/2" Drive Deep METRIC Socket Set**  
 Sizes: 10 to 24mm  
 Sale \$268.69 **Tool Club \$214.95**

**SKT1951**  
**21pc 1/2" Dr. METRIC Deep Set**  
 Sizes: 10 to 28, 30, 32mm.  
 Sale \$424.94 **Tool Club \$339.95**

**SKT4113-6**  
**13pc 1/2" Dr. SAE Short Set**  
 Sizes: 7/16" to 1-1/4".  
 Sale \$162.44 **Tool Club \$129.95**

**Eppy's is an Authorized SK Distributor!**  
 We stock all Sockets & Wrenches with a full **LIFETIME WARRANTY!**





# PROFESSIONAL REVERSIBLE RATCHETS



Completely enclosed ratchet mechanism. Diamond knurled grip.



## DOUBLE TOOTH RATCHET



120 tooth ratcheting mechanism

Part #	Drive	Length	Sale	Club
SKT40970	1/4"	4.5"	\$54.38	\$43.50
SKT40971	1/4"	6.5"	\$65.63	\$52.50
SKT45170	3/8"	7.6"	\$68.75	\$55.00
SKT45179	3/8"	10.3"	\$93.69	\$74.95
SKT42470	1/2"	10.3"	\$87.44	\$69.95
SKT40170	1/2"	15"	\$115.63	\$92.50
SKT45174	3/8"	4.8"	\$62.44	\$49.95

Part #	Drive	Sale	Club
SKT800700	1/4"	\$62.44	\$49.95
SKT800720	3/8"	\$78.69	\$62.95
SKT800740	1/2"	\$103.69	\$82.95

## LOW PROFILE RATCHET



Part #	Drive	Length	Sale	Club
SKT80180	1/4"	5"	\$70.63	\$56.50
SKT80182	1/4"	12"	\$99.94	\$79.95
SKT80200	3/8"	8"	\$95.63	\$76.50
SKT80202	3/8"	11"	\$106.19	\$84.95
SKT80203	3/8"	15"	\$124.94	\$99.95
SKT80220	1/2"	10"	\$123.69	\$98.95
SKT80221	1/2"	15"	\$156.19	\$124.95
SKT80222	1/2"	24"	\$187.44	\$149.95



- 90 tooth ratcheting mechanism
- Low 4° arc swing for tight spaces
- **Thin, low profile head for tight spaces**
- Quick change forward/reverse lever
- Redesigned ergonomic handle



## FLEX HEAD RATCHETS

SKT40972  
1/4" Dr. Professional Flex Head Ratchet  
Sale \$73.13 **Tool Club \$58.50**

SKT45178  
3/8" Dr. Professional Stubby Flex Head Ratchet  
Sale \$84.38 **Tool Club \$67.50**

SKT3770  
3/8" Dr. Professional Bent Flex Head Ratchet  
Sale \$91.19 **Tool Club \$72.95**

SKT45183  
3/8" Dr. Professional Flex Head Ratchet  
Sale \$93.69 **Tool Club \$74.95**

SKT80280  
1/4" Dr. LP90 Flex Head Teardrop Ratchet - 5"  
Sale \$97.44 **Tool Club \$77.95**

SKT80290  
3/8" Dr. LP90 Flex Head Teardrop Ratchet - 11"  
Sale \$124.94 **Tool Club \$99.95**

SKT80300  
1/2" Dr. LP90 Flex Head Teardrop Ratchet - 15"  
Sale \$162.44 **Tool Club \$129.95**

SKT80310  
1/2" Dr. LP90 Teardrop Flex Head Ratchet - 24"  
Sale \$186.88 **Tool Club \$149.50**

SKT42472  
1/2" Dr. Professional Flex Head Ratchet  
Sale \$124.94 **Tool Club \$99.95**

TIT11314  
1/4" Dr. Swivel Head Micro Ratchet - 4"  
90-Tooth reversible. 4° swing arc.  
Sale \$26.56 **Tool Club \$21.25**

TIT11315  
1/4" Dr. Swivel Head Micro Bit Holder - 4"  
90-Tooth reversible. 4° swing arc.  
Sale \$26.56 **Tool Club \$21.25**

# EXTENDABLE RATCHETS

Features:

- Providing additional reach for tough applications
- Push button quick release design
- Contoured cushion grip handle.



Part #	Drive	Length	Sale	Club
TIT12070	3/8"	8.75" - 12.75"	\$30.63	\$24.50
TIT12073	1/2"	18" - 24"	\$53.13	\$42.50
TIT12072	3/4"	19.5" - 30.5"	\$112.44	\$89.95

## LOW PROFILE FLEX HEAD



- **Low Profile Head**
- Extra Long

Part #	Drive	Sale	Club
EZRMR1412F	1/4" Flex	\$40.94	\$32.75
EZRMR3818F	3/8" Flex	\$55.94	\$44.75
EZRMR1224F	1/2" Flex	\$71.56	\$57.25

## ALUMINUM RATCHETS

- 90 TOOTH SEALED HEAD
- 4° SWEEP
- ANODIZED ALUMINUM HANDLE



Part #	Drive	Length	Sale	Club
TIT12160	1/4"	6"	\$34.38	\$27.50
TIT12161	3/8"	12"	\$45.63	\$36.50
TIT12162	1/2"	16"	\$59.38	\$47.50

SWIVEL HEAD

Part #	Drive	Length	Sale	Club
TIT12167	1/4"	6.5"	\$51.56	\$41.25
TIT12168	3/8"	10"	\$64.38	\$51.50

TIT12175  
5pc 90 Tooth Aluminum Ratchet Set  
1/4", 3/8", & 1/2" sealed head ratchets.  
1/4" & 3/8" flex head ratchets.  
Sale \$199.94 **Tool Club \$159.95**



EZRMR482FL  
Locking Flex Head Extendable Ratchet Set  
180° flexible angle. 72 tooth ratcheting head angles into tight work spaces. Unique, extendable locking shaft. Thermal plastic over-mold handle ensures firm grip. Sizes: 1/4", 3/8" & 1/2" Drive.  
Sale \$99.94 **Tool Club \$79.95**

## BREAKER BARS

**SKT45155**  
 3/8" Dr. Flex Head XXL - 15" Length  
 Sale \$62.44 **Tool Club \$49.95**



**SK** **MADE IN USA** **3/8**

**SKT41654**  
 1/2" Dr. Flex Head - 24" Length  
 Sale \$110.63 **Tool Club \$88.50**



**SK** **MADE IN USA** **1/2**

**SKT41656**  
 1/2" Dr. Flex Head XXL - 30" Length  
 Sale \$118.13 **Tool Club \$94.50**



**SK** **MADE IN USA** **1/2**

**TIT12047**  
 1/2" Dr. Breaker Bar - 30" Length  
 Sale \$41.88 **Tool Club \$33.50**



**TITAN** **1/2**

## XL BREAKER BARS

**TIT12048**  
 3/4" Dr. Breaker Bar - 40" Length  
 Sale \$92.81 **Tool Club \$74.25**



**TITAN** **3/4**

**TIT12049**  
 1" Dr. Breaker Bar - 40" Length  
 Sale \$109.38 **Tool Club \$87.50**



**TITAN** **1"**

## RATCHETING BREAKER BARS

Ratcheting swivel heads for tight access



**TIT12024**  
 1/2" Dr. Ratcheting - 24" Length  
 Sale \$52.94 **Tool Club \$42.35**

**TITAN** **1/2**

## RATCHET SETS

**KDT81271**  
 2pc 120XP™ Extra Long Handle Ratchet Set  
 Includes 1/4" & 3/8" ratchets  
 Sale \$108.69 **Tool Club \$86.95**



**KDT81207T**  
 3pc Dual Material Teardrop Ratchet Set  
 Includes 1/4, 3/8" & 1/2" ratchets.  
 Sale \$174.94 **Tool Club \$139.95**



**KDT81206P**  
 3pc 120XP Ratchet Set  
 1/4", 3/8", & 1/2" drive.  
 120 positions for 3° ratcheting arc.  
 Sale \$162.44 **Tool Club \$129.95**



**GEARWRENCH**

**KDT81203T**  
 3pc Dual Material Ratchet Set  
 Includes (1) 1/4" & (1) 3/8" ratchets  
 & (1) 3/8" flex ratchet.  
 Sale \$177.44 **Tool Club \$141.95**



**KDT81298T**  
 3pc Dual Material Locking Flex Head Ratchet Set  
 Includes 1/4", 3/8" & 1/2" ratchets.  
 90 Tooth gear with a 4° swing arc.  
 Sale \$223.13 **Tool Club \$178.50**



**NEW!**

**KDT81230P**  
 4pc 120XP Flex Head Ratchet Set  
 Includes 1/4", 3/8", & 1/2" ratchets.  
 6 position flex head and 3° ratcheting arc.  
 Sale \$233.13 **Tool Club \$186.50**



## RATCHETS

**IRT759991**  
 1/4" Dr. 90T Ratchet w/ Double Injection Handle  
 90 Tooth precision machined gears.  
 4° swing angle. Sealed head for increased durability. Ergonomic comfort grip handle.  
 Sale \$31.24 **Tool Club \$24.99**



**NEW!** **IR**

**IRT759992**  
 3/8" Dr. 90T Ratchet w/ Double Injection Handle  
 90 Tooth precision machined gears.  
 4° swing angle. Sealed head for increased durability. Ergonomic comfort grip handle.  
 Sale \$42.44 **Tool Club \$33.95**



**NEW!** **IR**

**IRT759993**  
 1/2" Dr. 90T Ratchet w/ Double Injection Handle  
 90 Tooth precision machined gears.  
 4° swing angle. Sealed head for increased durability. Ergonomic comfort grip handle.  
 Sale \$53.74 **Tool Club \$42.99**



**NEW!** **IR**

**IRT752026**  
 3pc 90 Tooth Ratchet Master Set  
 Sizes: 1/4" Drive, 3/8" Drive & 1/2" Drive.  
 90 Tooth precision machined gears.  
 4° swing angle. Sealed head for increased durability. Ergonomic comfort grip handle.  
 Includes brushed aluminum accented EVA organization tray.  
 Sale \$124.94 **Tool Club \$99.95**



**NEW!** **IR**

**TIT12045**  
 3/8" Dr. X-Long Offset Ratchet  
 10.5" long.  
 Sale \$28.44 **Tool Club \$22.75**



**TITAN** **3/8**

**TIT12046**  
 1/2" Dr. X-Long Offset Ratchet  
 13.25" long.  
 Sale \$32.44 **Tool Club \$25.95**



**TITAN** **1/2**

## GEARWRENCH

Features:

- 3° Ratcheting Arc
- 6 Position Flex Head
- Enclosed Head Design for Extreme Resistance to Dirt Infiltration

**NEW!**



Part #	Drive	Length	Sale	Club
KDT81011P	1/4"	5"	\$39.38	<b>\$31.50</b>
KDT81212T	3/8"	5"	\$58.69	<b>\$46.95</b>
KDT81211T	3/8"	8"	\$51.88	<b>\$41.50</b>
KDT81211P	3/8"	8-1/4"	\$71.56	<b>\$57.25</b>
KDT81304P	1/2"	11"	\$78.13	<b>\$62.50</b>

## 120XP™ FLEX HEAD TEARDROP RATCHETS



Part #	Drive	Length	Sale	Club
KDT81012P	1/4"	6"	\$44.69	<b>\$35.75</b>
KDT81215P	3/8"	11"	\$74.94	<b>\$59.95</b>
KDT81306P	1/2"	17"	\$88.69	<b>\$70.95</b>

## EXTRA LONG HANDLE TEARDROP RATCHETS

Features:

- 3° Ratcheting Arc
- Extra-Long Handle for Hard-to-Reach Spots
- 120XP™ Ratchet Head
- Flush-Mounted Forward/Reverse Lever



Part #	Drive	Length	Sale	Club
KDT81034	1/4"	9"	\$47.81	<b>\$38.25</b>
KDT81269	3/8"	18"	\$80.44	<b>\$64.35</b>
KDT81364	1/2"	24"	\$116.19	<b>\$92.95</b>



**Features: Patented 120XP Head, Formed Low Profile Tubing, HD Scale in SAE & Metric, & Case**

Part #	Drive	Range	Sale	Club
KDT85171	1/4"	30-200 in/lbs.	\$212.44	<b>\$169.<sup>95</sup></b>
KDT85176	3/8"	10-100 ft/lbs.	\$224.94	<b>\$179.<sup>95</sup></b>
KDT85181	1/2"	30-250 ft/lbs.	\$281.19	<b>\$224.<sup>95</sup></b>
KDT85065	3/4"	100-600 ft/lbs.	\$862.44	<b>\$689.<sup>95</sup></b>



**Features: Quick release socket retention. Knurled metal handle. Easy to read dual scale. Positive lock collar.**

Part #	Drive	Range	Sale	Club
SKT77002	1/4"	20-150 in/lbs.	\$312.44	<b>\$249.<sup>95</sup></b>
SKT77025	3/8"	30-250 in/lbs.	\$249.94	<b>\$199.<sup>95</sup></b>
SKT77100	3/8"	10-100 ft/lbs.	\$249.94	<b>\$199.<sup>95</sup></b>
SKT77150	1/2"	20-120 ft/lbs.	\$274.94	<b>\$219.<sup>95</sup></b>
SKT77250	1/2"	30-250 ft/lbs.	\$287.44	<b>\$229.<sup>95</sup></b>
SKT77600	3/4"	100-600 ft/lbs.	\$999.94	<b>\$799.<sup>95</sup></b>

**FLEX HEAD TORQUE WRENCHES**



**Features: Torque-setting adjustment requires only fingertip force. No need to wind down after use.**

Part #	Drive	Range	Sale	Club
PREC2FR100F	3/8"	20-100 ft/lbs.	\$224.94	<b>\$179.<sup>95</sup></b>
PREC3FR250F	1/2"	40-250 ft/lbs.	\$287.44	<b>\$229.<sup>95</sup></b>

**E-SPEC TORQUE WRENCHES**



**Features: 100 available preset torque settings, simple 2 button menu w/ reversible screen, includes rechargeable Li-ion Battery & AAA Battery Cartridge**

Part #	Drive	Range	Sale	Club
KDT85235	1/4"	5 - 25Nm	\$687.44	<b>\$549.<sup>95</sup></b>
KDT85237	3/8"	20 - 100Nm	\$687.44	<b>\$549.<sup>95</sup></b>
KDT85238	1/2"	68 - 340Nm	\$749.94	<b>\$599.<sup>95</sup></b>

**HD ELECTRONIC TORQUE WRENCHES**



**Features: "Target Torque Alert" gives a warning as you approach your target torque, 24 Tooth Head.**

Part #	Drive	Range	Sale	Club
KDT85082	3/4"	70 - 750 ft/lbs.	\$1,499.94	<b>\$1,199.<sup>95</sup></b>
KDT85085	1"	150 - 1,000 ft/lbs.	\$1,749.94	<b>\$1,399.<sup>95</sup></b>



**Features: Patented 120XP 15° Flex Head, Formed Low Profile Tubing, Vibrating handle, buzzer, and LCD screen alert when target torque is reached. Digital Scale in ft-lb, in-lb, Nm, Kg-m, and Kg-cm, & Case**

Part #	Drive	Range	Sale	Club
KDT85194	1/4"	2-20 ft/lbs.	\$305.63	<b>\$244.<sup>50</sup></b>
KDT85195	3/8"	10-100 ft/lbs.	\$318.69	<b>\$254.<sup>95</sup></b>
KDT85196	1/2"	25-250 ft/lbs.	\$362.44	<b>\$289.<sup>95</sup></b>

**ELECTRONIC TORQUE WRENCHES**



**Features: Handle vibrates, buzzer sounds, & LED light alerts when target torque is being reached.**

Part #	Drive	Range	Sale	Club
KDT85078	3/8"	7.1-99.6 ft/lbs.	\$324.94	<b>\$259.<sup>95</sup></b>
KDT85079	1/2"	40-250 ft/lbs.	\$362.44	<b>\$289.<sup>95</sup></b>



**AFF41055**  
1" Ratcheting Torque Wrench  
Range: 100 - 700 ft/lbs. 48" long. Perceptible jolt & audible click.  
Sale \$874.94 **Tool Club \$699.<sup>95</sup>**

**TORQUE MULTIPLIERS**



Ratio: 4:1

**Increases the altitude of your wrench by torque. Designed with four pinion gears in a compact housing.**

**CEN6380**  
22" Torque Multiplier - 1,000 Ft. Lbs.  
Input: 1/2" Drive;  
Output: 3/4" Drive  
Sale \$536.19 **Tool Club \$428.<sup>95</sup>**

**CEN6387**  
25" Torque Multiplier - 2,000 Ft. Lbs.  
Input: 3/4" Drive;  
Output: 1" Drive  
Sale \$687.44 **Tool Club \$549.<sup>95</sup>**

**KTA34688**  
5:1 Torque Multiplier  
Accuracy better than ±5%  
Input: 3/4" Drive; Output: 1" Drive.  
Reaction bar supplied in two styles for maximum versatility.  
Sale \$637.44 **Tool Club \$509.<sup>95</sup>**



**AST78810**  
10pc 1/2" Drive Torque Aluminum Extension Set  
8" Extensions Sizes: 65, 75, 80, 90, 100, 110, 120, 130, 140 & 150ft/lbs.  
Sale \$118.13 **Tool Club \$94.<sup>50</sup>**



**LIS28100**  
Torque Angle Meter  
Use with 1/2" drive to tighten head bolts and other bolts where a torque angle is required.  
Sale \$51.56 **Tool Club \$41.<sup>25</sup>**



## 1/4" DRIVE EXTENSIONS SETS

**SKT4916T**  
6pc 1/4" Dr. SuperKrome® Extension Set  
Sizes: 2", 3", 6", 8", 10" & 14"  
Sale \$96.19 **Tool Club \$76.95**

**SKT40936**  
6pc 1/4" Dr. SuperKrome® Wobble Extension Set  
Sizes: 1-1/2", 2", 4", 6", 10" & 14"  
Sale \$104.38 **Tool Club \$83.50**

**SKT4941**  
3pc 1/4" Dr. SuperKrome® Locking Extension Set  
Sizes: 3", 7" & 15"  
Sale \$131.19 **Tool Club \$104.95**

**TIT66940**  
3pc 1/4" Dr. Extension Set  
Sizes: 2", 4" & 6"  
Sale \$12.44 **Tool Club \$9.95**

**KDT81002**  
5pc 1/4" Dr. Extension Set  
Sizes: 2", 3", 4", 6" & 14"  
Sale \$40.94 **Tool Club \$32.75**

**TIT12082**  
3pc Socket Adapters  
Sale \$6.56 **Tool Club \$5.25**

**TIT15214**  
3pc 6" Locking Socket Adapter Set  
1/4", 3/8" & 1/2" drive  
Sale \$28.69 **Tool Club \$22.95**

**TIT12086**  
6" Long Socket Adapters  
Sale \$11.56 **Tool Club \$9.25**

**TIT15206**  
3pc X-Long Socket Adapters - 12"  
Sale \$24.38 **Tool Club \$19.50**

**TIT12089**  
9pc Impact Socket Adapter Set  
Sizes - 1/4" Dr.: 2-1/2", 6" & 12"; 3/8" Dr.: 2-1/2", 6" & 12"; 1/2" Dr.: 2-3/4", 6" & 12".  
Sale \$39.69 **Tool Club \$19.50**

## 3/8" DRIVE EXTENSIONS SETS

**SKT4514**  
4pc 3/8" Dr. Extension Set  
Sizes: 1-1/2", 3", 6" & 12"  
Sale \$74.38 **Tool Club \$59.50**

**SKT4524**  
4pc 3/8" Dr. Wobble Extension Set  
Sizes: 3", 6", 8" & 12"  
Sale \$87.44 **Tool Club \$69.95**

**SKT4538**  
8pc 3/8" Dr. Extension Set  
Sizes: 1-1/2", 3", 4", 6", 8", 10", 18" & 24"  
Sale \$174.94 **Tool Club \$139.95**

**SKT4516**  
3pc 3/8" Dr. Locking Extension Set  
Sizes: 7-1/2", 13-1/2" & 19-1/2"  
Sale \$174.94 **Tool Club \$139.95**

**TIT68152**  
4pc 3/8" Dr. Extension Set  
Sizes: 1-3/4", 3", 6" & 8"  
Sale \$17.19 **Tool Club \$13.75**

**KDT81200**  
4pc 3/8" Dr. Extension Set  
Sizes: 1-1/2", 3", 6" & 12"  
Sale \$34.94 **Tool Club \$27.95**

**VIMDSE46**  
1/4" Dr. 6" Dual Swivel Extension  
6" Long With Locking Square Drive. Made from durable rust-resistant material for long-lasting performance.  
Sale \$37.44 **Tool Club \$29.95**

**VIMDSE68**  
3/8" Dr. 8" Dual Swivel Extension  
8" Long With Locking Square Drive. Made from durable rust-resistant material for long-lasting performance.  
Sale \$45.63 **Tool Club \$36.50**

## 1/2" DRIVE EXTENSIONS SETS

**SKT4114**  
3pc 1/2" Dr. Extension Set  
Sizes: 5", 10" & 20"  
Sale \$95.63 **Tool Club \$76.50**

**SKT40165**  
5pc 1/2" Dr. Extension Set  
Sizes: 2", 3", 5", 10" & 15"  
Sale \$118.69 **Tool Club \$94.95**

**SKT40208**  
5pc 1/2" Dr. Wobble Extension Set  
Sizes: 2", 3", 5", 10" & 15"  
Sale \$143.69 **Tool Club \$114.95**

**TIT12081**  
3pc 1/2" Dr. Extra Long Extension Bar Set  
Sizes: 18", 24" & 30" for increased access.  
Sale \$31.19 **Tool Club \$24.95**

**TIT62140**  
3pc 1/2" Dr. Extension Set  
Sizes: 3", 5" & 8"  
Sale \$21.19 **Tool Club \$16.95**

**TIT62141**  
3pc 1/2" Dr. Wobble Set  
Sizes: 3", 5" & 8"  
Sale \$24.94 **Tool Club \$19.95**

**VIMDSE812**  
1/2" Dr. 12" Dual Swivel Extension  
12" Long With Locking Square Drive. Made from durable rust-resistant material for long-lasting performance.  
Sale \$49.38 **Tool Club \$39.50**



### SKT4010 9pc Universal Adapter Set

1/4" & 3/8" Chrome Universals,  
3/8" & 1/2" Impact Universals,  
1/4", 3/8", & 1/2"  
Male / Female Chrome Adapters  
Sale \$212.44 **Tool Club \$169.95**



### KDT80565 10pc 3/8" Dr METRIC Flex Socket Set

Sizes: 10 - W19mm  
Sale Price \$120.63 **Tool Club \$96.50**



### KDT80564 7pc 3/8" Dr SAE Flex Socket Set

Sizes: 3/8" - 3/4".  
Sale Price \$96.19 **Tool Club \$76.95**



**KDT80304**  
13pc 1/4" Dr  
**METRIC Deep Socket Set** **3/8 MM 6 PT**  
Sizes: 4mm - 15mm.  
Sale Price \$68.69 **Tool Club \$54.95**

## GW GEARWRENCH

All Sets Include Flex, Deep, Mid-Length,  
Standard, Magnetic Sockets,  
and Storage Rail.

### KDT80102 5pc 8mm Socket Set 1/4" Drive

Sale \$24.94 **Tool Club \$19.95**



### KDT80319 10pc 10mm Socket Set

1/4" & 3/8" Drive  
Sale \$54.38 **Tool Club \$43.50**



### KDT80576 10pc 12mm Socket Set

1/4" & 3/8" Drive  
Sale \$53.13 **Tool Club \$42.50**



## CHROME ADAPTERS



Part #	Description	Sale	Club
SKT384	3/8"F - 1/4"M	\$14.38	<b>\$11.50</b>
SKT401	1/2"F - 3/8"M	\$21.88	<b>\$17.50</b>
SKT407	1/2"F - 3/4"M	\$24.94	<b>\$19.95</b>
SKT409	3/4"F - 1/2"M	\$29.38	<b>\$23.50</b>
SKT385	1/4"F - 3/8"M	\$14.38	<b>\$11.50</b>
SKT451	3/8"F - 1/2"M	\$14.94	<b>\$11.95</b>

## CHROME U-JOINTS

Part #	Drive	Sale	Club
SKT40990	1/4"	\$28.69	<b>\$22.95</b>
SKT45190	3/8"	\$34.38	<b>\$27.50</b>
SKT40190	1/2"	\$41.88	<b>\$33.50</b>



### SKT4506 5pc Adapter Set

1/4"F-3/8"M, 3/8"F-1/4"M,  
3/8"F-1/2"M, 1/2"F-3/8"M  
& 1/2"F-3/4"M  
Sale \$62.44 **Tool Club \$49.95**



## CALIPERS

**CEN3M430A**  
Electronic Digital Rotor  
Gauge: 0 - 5.6"  
Sale \$79.69  
**Tool Club \$63.75**



**CEN3B351**  
Electronic  
Brake Drum Micrometer:  
6-20.65" Range  
.0005" Graduations  
Sale \$249.94  
**Tool Club \$199.95**



**CEN6420**  
Caliper:  
0 - 6"  
.001"/.02mm graduations.  
Sale \$116.56  
**Tool Club \$93.25**

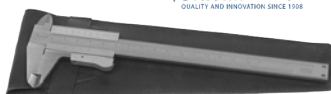

**CEN3C351**  
Carbon Fiber Digital  
Caliper with Fractional Display  
Range: 0-6"/0-150mm; Inch, Metric and  
Fractional reading.  
Sale \$23.13 **Tool Club \$18.50**



## MICROMETERS



**CEN3M116**  
Conventional Micrometer 6pc Set: 0-6"  
Sale \$334.94 **Tool Club \$267.95**



Part #	Range	Sale	Club
CEN3M101	0 - 1"	\$50.31	<b>\$40.25</b>
CEN3M102	1" - 2"	\$51.56	<b>\$41.25</b>
CEN3M104	3" - 4"	\$71.56	<b>\$57.25</b>
CEN3M105	4" - 5"	\$75.31	<b>\$60.25</b>

**CEN3M114**  
3pc Micrometer Set  
Includes:  
0 - 1" micrometer,  
1" - 2" micrometer,  
2" - 3" micrometer.  
Sale \$209.69  
**Tool Club \$167.75**



## BRAKE MICROMETERS

**CEN3M130**  
Disc Brake Micrometer:  
0.3" - 1.3"  
Sale \$96.19  
**Tool Club \$76.95**



## STRAIGHT EDGES



Part #	Length	Sale	Club
CEN6475	18"	\$113.44	<b>\$90.75</b>
CEN6429	24"	\$123.69	<b>\$98.95</b>
CEN6431	35"	\$151.19	<b>\$120.95</b>

ADAPTERS

MEASURING

**CEN3D102**  
Dial Indicator Set with  
On/Off Magnetic Base  
Measures 0" to 1" in .001"  
graduations. Flex-arm.  
Sale \$137.44  
**Tool Club \$109.95**



**CEN3D105**  
Dial Indicator Set with  
On/Off Magnetic Base  
Measures 0" to 1" in .001"  
graduations.  
Sale \$179.38  
**Tool Club \$143.50**



**CEN3D103**  
Rotor Runout/  
Ball Joint Gauge Set  
Includes: Dial indicator,  
locking plier  
clamp with adjustable  
flex-arm & plastic box.  
Sale \$109.94  
**Tool Club \$87.95**



**CEN3S116**  
Telescoping Gauge Set  
Sizes: 5/16" - 6"  
Sale \$45.94  
**Tool Club \$36.75**



**CEN3D302**  
Cylinder Bore  
Gauge: 2" - 6"  
Sale \$174.94  
**Tool Club \$139.95**



**CEN3M336**  
STORM™ Wheels On Rotor Gauge  
Low profile to check rotors with wheel on.  
Interchangeable pointed/flat anvil,  
Sale \$124.94 **Tool Club \$99.95**





**VIMFRBS89**  
**89pc Bit Set with 1/4" Flex Ratchet**  
 Set includes a wide array of popular bits: metric & SAE hex, Phillips, ACR, slotted, triple square (XZN), TORX®, TORX® Plus, TORX® tamper resistant, TORX® Plus tamper resistant, MORTORQ, square (Robertson) & clutch.  
 Sale \$137.44 **Tool Club \$109.95**

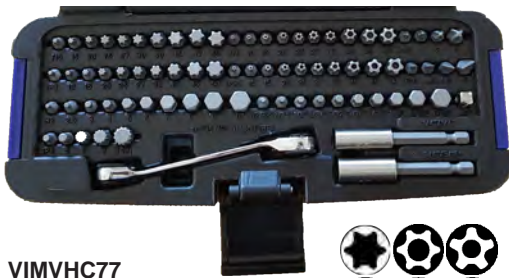

**VIMVHC77**  
**77pc Half Cut Stubby Bit Set**  
 Includes: 5/8" Bits For Torx, Torx Plus, Tamper Proof Torx, Triple Square, 5 Pt. Tamper Proof, SAE & Metric Hex, Flathead & Phillips.  
 Sale \$137.44 **Tool Club \$109.95**



**VIMHMS26**  
**26pc SAE & METRIC Master Hex Socket Bit Set**  
**METRIC:** 2 - 19mm, **SAE:** 3/32" - 3/4"  
 Sale \$106.19 **Tool Club \$84.95**



**VIMTMS34PF**  
**34pc Master Torx Set**  
 Torx sizes: T8 to T60  
 Female Torx: E4 to E20  
 Tamperproof: T10 to T55  
 Sale \$119.38 **Tool Club \$95.50**



**VIMXZN100**  
**8pc Stubby Triple Square**  
 Sizes: 4, 5, 6, 8, 10, 12, 14 & 16mm  
 Sale \$43.13 **Tool Club \$34.50**



**VIMXZN400-03**  
**9pc X-Long Triple Square Bits**  
 Sizes: 4, 5, 6, 8, 10, 12, 14, 16 & 18mm. 4" long  
 Sale \$71.88 **Tool Club \$57.50**



**VIMHCT1050-03**  
**10pc Stubby Torx Set**  
 Sizes: T10, T15, T20, T25, T27, T30, T40, T45, T47 & T50. Only 3/4" long.  
 Sale \$41.19 **Tool Club \$32.95**



**VIMV5PSD**  
**10pc Security Driver Set**  
**Tamperproof Torx PLUS®**  
 5 Point. Sizes: SD8-SD50.  
 Sale \$59.94 **Tool Club \$47.95**



**VIMV458LSET**  
**18pc X-Long Torx Set**  
 Sizes: T10, T15, T20, T25, T27, T30, T40, T45 & T50.  
 Each size comes 4.5" and 8" long.  
 Sale \$114.38 **Tool Club \$91.50**



**VIMDD2**  
**1/4" Dual Drive Micro Ratchet**  
 Removable 1/4" square drive & 1/4" offset square in handle. Thumb wheel for finger tip control in tight areas. 60° fine tooth ratchet for high torque applications.  
 Sale \$35.63 **Tool Club \$28.50**



**VIMVDE418**  
**11pc "E" Torx Set**  
 Sizes: E4, E5, E6, E7, E8, E10, E11, E12, E14, E16 & E18 deep sockets.  
 Sale \$48.69 **Tool Club \$38.95**



**VIMDD3**  
**3/8" Dual Drive Micro Ratchet**  
 Removable 3/8" square drive & 3/8" offset square in handle. Thumb wheel for finger tip control in tight areas. 60° fine tooth ratchet for high torque applications.  
 Sale \$41.19 **Tool Club \$32.95**

**SCREWDRIVERS**

**WIHA77790**  
**26-in-1 Ultra Driver Tradesman**  
 Bit storage in handle.  
 13 Premium double-ended bits with Phillips, Slotted, TORX, Square, Hex Inch & Metric, Pozi  
 Sale \$41.19  
**Tool Club \$32.95**



**VIMTPXL08**  
**X-Long Tamperproof & Tamperproof Plus**  
 Sizes: T10, T15, T20, T25, T27, T30 & T40.  
 2 way handle.  
 Sale \$76.19  
**Tool Club \$60.95**



**VIMTPI100**  
**Tamperproof Torx Screwdriver Set**  
 Sizes: T10, T15, T20, T25, T27 & T30.  
 Sale \$36.56  
**Tool Club \$29.25**



**VIMTORXTBS**  
**Torx Truck Bed Set**  
 T40, T45, T50 & T55 IP45, IP50 & IP55 TORX PLUS SOCKET EP24  
 Sale \$39.94 **Tool Club \$31.95**



**VIMMMS450**  
**50pc 1/4" Dr. Mechanics Master Set**  
 Hex Drivers 5/64" - 3/8"  
 Hex Drivers 2mm - 10mm, P1 & P2 phillips drivers, 1/4" & 3/8" Blade drivers, XZN drivers XZN4 through XZN12, TORX PLUS drivers IP15 through IP50, TORX drivers T8 - T50  
 Sale \$137.44 **Tool Club \$109.95**



**VIMIMP600**  
**3/8" Square Drive Impact Driver**  
 Works with any 3/8" Dr. impact socket as well as any 5/16" impact bit.  
 Sale \$99.94 **Tool Club \$79.95**



**VIMHXL100**  
**14pc SAE Long Hex Driver Set**  
 Ball Hex Sizes: 1/8" - 3/8"  
 Hex Sizes: 1/8" - 3/8"  
 Sale \$91.56  
**Tool Club \$73.25**



**VIMHXL100**  
**14pc Metric Long Hex Driver Set**  
 Ball Hex Sizes: 3mm - 8mm & 10mm  
 Hex Sizes: 3mm - 8mm & 10mm  
 Sale \$87.44  
**Tool Club \$69.95**



**TIT16122**  
**13pc Torx Bit Set**  
 Sizes: T10, T15, T20, T25, T27, T30, T40, T45, T47, T50, T55, T60 & T70.  
 Sale \$46.88 **Tool Club \$37.50**



**TIT68965**  
**3/8" Dr. Mortorq Socket Set**  
 Sizes: MST-0, MST-1, MST-2, MST-3, & MST-4  
 Sale \$29.94 **Tool Club \$23.95**



**TIT16121**  
**12pc Tamperproof Torx Bit Set**  
 1/4" Drive: T10 - T30;  
 3/8" Drive: T40 - T60  
 Sale \$45.63 **Tool Club \$36.50**



**TIT16142**  
**10pc Stubby Torx Bit Socket Set**  
 1/4" Drive: T10, T15, T20, T25, T27 & T30 ;  
 3/8" Drive: T40, T45, T47 & T50.  
 Sale \$32.44 **Tool Club \$25.95**



**TIT17403**  
**13pc E Torx Socket Set**  
 E4, E5, E6, E7, E8, E10, E12, E14, E16, E18, E20, E22, E24.  
 Sale \$55.63 **Tool Club \$44.50**



**TIT16143**  
**10pc Tamperproof Stubby Torx Bit Set**  
 1/4" Drive: T10, T15, T20, T25, T27, T30;  
 3/8" Drive: T40, T45, T47 and T50  
 Sale \$41.88 **Tool Club \$33.50**



**TIT16123**  
**13pc SAE Hex Bit Socket Set**  
 5/64", 3/32", 7/64", 1/8", 9/64", 5/32", 3/16", 7/32", 1/4", 5/16", 3/8", 7/16", 1/2"  
 Sale \$46.88 **Tool Club \$37.50**



**TIT16140**  
**9pc Stubby SAE Hex Impact Set**  
 1/4" Dr: 1/4", 5/16" & 3/8"  
 3/8" Dr: 7/16", 1/2", 9/16", 5/8", 11/16" & 3/4"  
 Sale \$32.44 **Tool Club \$25.95**



**TIT16130**  
**6pc 1/2" Dr SAE Hex Bit Socket Set**  
 Sizes: 9/16", 5/8", 11/16", 3/4", 13/16" & 7/8"  
 Sale \$53.13 **Tool Club \$42.50**



**TIT16141**  
**9pc Stubby METRIC Hex Impact Set**  
 1/4" Dr: 6, 7, 8 & 10mm  
 3/8" Dr: 12, 14, 17, 18 & 19mm  
 Sale \$32.44 **Tool Club \$25.95**



**TIT16124**  
**13pc METRIC Hex Bit Socket Set**  
 2, 2.5, 3, 4, 5, 5.5, 6, 7, 8, 9, 10, 11, 13mm  
 Sale \$46.88 **Tool Club \$37.50**



**TIT17209**  
**7pc Tamperproof Torx Screwdriver Set**  
 Sizes: T8, T10, T15, T20, T25, T27, T30.  
 Sale: \$41.88 **Tool Club \$33.50**



**TIT12734**  
**10pc Tamper-Proof 5 PT Torx Key Set**  
 Sizes: T6, T7, T8, T9, T10, T15, T20, T25, T27, T30, T40, T45 & T50  
 Sale \$33.69 **Tool Club \$26.95**



**TIT12715**  
**13pc Tamperproof Torx Set**  
 Sizes: T6, T7, T8, T9, T10, T15, T20, T25, T27, T30, T40, T45 & T50.  
 Sale \$39.69 **Tool Club \$31.75**

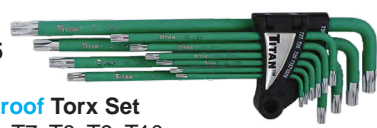

**TIT16131**  
**7pc METRIC Hex Set**  
 Sizes: 13, 14, 15, 17, 19, 21 & 22mm.  
 All 1/2" Drive.  
 Sale \$55.63 **Tool Club \$44.50**



**TIT16138**  
**9pc 3/8" Drive Stubby Triple Square Set**  
 Sizes: M4, M5, M6, M8, M10, M12, M14, M16 & M18.  
 Sale \$32.44 **Tool Club \$25.95**



**TIT12713**  
**13pc Long SAE Ball Hex Set**  
 Sizes: 0.05", 1/16", 5/64", 3/32", 7/64", 1/8", 9/64", 5/32", 3/16", 7/32", 1/4", 5/16" & 3/8"  
 Sale \$33.69 **Tool Club \$26.95**



**TIT12768**  
**8pc SAE T-Handle Hex Key Set**  
 Sizes: 3/32", 7/64", 1/8", 9/64", 5/32", 3/16", 7/32", & 1/4".  
 Sale \$19.06 **Tool Club \$15.25**



**TIT16144**  
**9pc Triple Square Set**  
 M4, M5, M6, M8, M10, M12, M14, M16, M18  
 Sale \$41.88 **Tool Club \$33.50**



**TIT12714**  
**9pc Long METRIC Ball Hex Set**  
 Sizes: 1.5, 2, 2.5, 3, 4, 5, 6, 8, 9 & 10mm  
 Sale \$29.38 **Tool Club \$23.50**



**TIT12769**  
**6pc METRIC T-Handle Hex Key Set**  
 Sizes: 2, 2.5, 3, 4, 5, & 6mm.  
 6" long handles.  
 Sale \$18.69 **Tool Club \$14.95**



**TIT16132**  
**8pc SAE/Metric Large Hex Bit Socket Set**  
 Sizes: 9/16" - 3/4" & 14mm - 19mm.  
 1/2" Drive. Includes magnetic socket rail.  
 Sale \$55.63 **Tool Club \$44.50**



**TIT12733**  
**8pc Triple Square L-Wrench Set**  
 Sizes: M3, M4, M5, M6, M8, M9, M10, M12.  
**ONLY SET WITH M9!**  
 Sale \$33.69 **Tool Club \$26.95**



**LIS27200**  
**12pc Torx Set**  
 Sizes: T10, T15, T20, T25, T27, T30, T40, T45, T47, T50, T55 & T60.  
 Sale \$47.81  
**Tool Club \$38.25**



**LIS26280**  
**10pc Female Torx**  
 Sizes: E5, E6, E7, E8, E10, E12, E14, E16, E18 & E20  
 Sale \$46.88 **Tool Club \$37.50**



**KDT9224D**  
**4pc Ratcheting Female Torx Set**  
 Sizes: E6 - E24.  
 Sale \$131.19  
**Tool Club \$104.95**



**LIS83100**  
**9pc External Torx Plus Set**  
 Sizes: EP6, EP7, EP8, EP9, EP10, EP11, EP12, EP14, EP16, EP18.  
 Sale \$44.38  
**Tool Club \$35.50**



**CTA9650**  
**8pc External Torx PLUS®**  
 Sizes: EP6 - EP18.  
 Black impact quality finish.  
 Sale \$48.69 **Tool Club \$38.95**



**SUN2690S**  
**8pc Torx Impact Socket Set**  
 1/2" drive.  
 Sizes: T30, T40, T45, T47, T50, T55, T60, T70.  
 Sale \$53.44  
**Tool Club \$42.75**



**SUN3841**  
**11pc 3/8" Dr. Pipe Plug Socket Set**  
 Internal: 3/16", 1/4", 9/32", 5/16", 11/32" & 3/8"  
 External: 1/4", 9/32", 5/16", 11/32" & 3/8"  
 Sale \$86.56  
**Tool Club \$69.25**



**CTA9666**  
**3pc Torx PLUS® Socket Set**  
 Sizes: EP20, EP22, EP24.  
 Services elliptical-shaped fasteners on Ford Super-Duty, Honda Civics, Nissan Altima & Rogue, more.  
 Sale \$28.13 **Tool Club \$22.50**



**SUN2690SE**  
**9pc E-Torx Impact Socket Set**  
 1/2" drive.  
 Sizes: E10, E11, E12, E14, E16, E18, E20, E22, E24.  
 Sale \$57.81  
**Tool Club \$46.25**



**SUN2639L**  
**10pc METRIC Hex Impact Set**  
 6" Long  
 Sizes: 6, 7, 8, 10, 12, 14, 15, 17, 18, & 19mm.  
 Sale \$123.69  
**Tool Club \$98.95**



**KDT80742**  
**84pc Master Bit Set**  
 Includes: 1/4", 3/8", & 1/2" Standard and Long Hex, Ball End Hex, Tamper-proof Torx, E-Torx, & Torx. SAE & Metric Hex sizes.  
 Sale \$237.44 **Tool Club \$189.95**



**SUN2637**  
**20pc 1/2" Dr. SAE & METRIC Master Impact Hex Driver Set**  
 Sizes: 1/4", 5/16", 3/8", 7/16", 1/2", 9/16", 5/8", 11/16", 3/4", 9/32", 6, 7, 8, 10, 12, 14, 15, 17 - 19mm.  
 Sale \$156.69  
**Tool Club \$125.35**



**SUN2638L**  
**10pc SAE Hex Impact Set**  
 6" Long  
 Sizes: 1/4", 9/16", 5/16", 3/8", 7/16", 3/4", 11/16", 5/8", 9/16", & 1/2".  
 Sale \$125.00  
**Tool Club \$100.00**



**SUN2638**  
**10pc SAE Impact Hex Driver Set**  
 Sizes: 1/4", 9/32", 5/16", 3/8", 7/16", 1/2", 9/16", 5/8", 11/16" & 3/4"  
 Sale \$93.13  
**Tool Club \$74.50**



**SUN2637L**  
**20pc 1/2" Dr. SAE & METRIC Master Impact X-Long Hex Driver Set**  
 6" long.  
 Sizes: 1/4" - 1/2". 6 - 19mm.  
 Includes carrying case.  
 Sale \$230.94  
**Tool Club \$184.75**



**SUN2639**  
**10pc METRIC Hex Driver Set**  
 Sizes: 6, 7, 8, 10, 12, 14, 15, 17, 18 & 19mm  
 Sale \$82.44  
**Tool Club \$65.95**



**SUN2638**  
**10pc SAE Impact Hex Driver Set**  
 Sizes: 1/4", 9/32", 5/16", 3/8", 7/16", 1/2", 9/16", 5/8", 11/16" & 3/4"  
 Sale \$93.13  
**Tool Club \$74.50**



**SUN4507**  
**5pc METRIC Impact Hex Set**  
 Large Sizes: 14, 17, 19, 22 & 24mm  
 Sale \$119.94  
**Tool Club \$95.95**



**SUN4506**  
**5pc SAE Impact Hex Set**  
 Large Sizes: 3/4", 7/8", 1", 1-1/8" & 1-1/4"  
 Sale \$119.94  
**Tool Club \$95.95**



**SUN9921**  
**14pc Long METRIC Ball Hex & Hex Bit Set**  
 Sizes: 3, 4, 5, 6, 7, 8 & 10mm  
 Sale \$86.56 **Tool Club \$69.25**



**WILW54287**  
**15pc Drain Plug Socket Set**  
 Sizes: (Hex) 9, 10, 12, 14 and 17mm; (Square) 7, 8, 11, 13mm, 5/16", 3/8"; (Female Square) 10mm; (Male Triangle) 10mm, (Tamper-proof Triple Square) 16mm  
 Sale \$42.44 **Tool Club \$33.95**



**SUNEX TOOLS**  
**SUN3569**  
**84pc 3/8" Dr. Master Impact Bit Set**  
 Hex Bits: SAE & Metric stubby, regular, long.  
 Torx Bits: T20 - T55  
 E-Torx: E5 - E15  
**Tamperproof Torx: T10 - T50**  
**Triple Square: M4 - M16**  
 Sale \$262.44 **Tool Club \$209.95**





## 12 PT AXLE SOCKETS

### SUN2835

8pc 12pt Spindle Nut Socket Set  
 Sizes: 29, 30, 32, 34, 35, 36, 38 & 39mm.  
 Sale \$173.13

**Tool Club \$138.50**



### SUN2837

4pc Set  
 Sizes: 30, 32, 34 & 36mm.  
 Sale \$105.63

**Tool Club \$84.50**



Part #	Size	Sale	Club
LIS39510	30mm	\$22.19	\$17.75
SUN230ZMD	30mm	\$17.44	\$13.95
SUN232ZMD	32mm	\$18.69	\$14.95
SUN234ZMD	34mm	\$20.63	\$16.50
SUN2802ZD	36mm	\$34.06	\$27.25
LIS39650	39mm	\$23.13	\$18.50

### CTAA433 46mm 1/2" Dr. Front Wheel Bearing Retaining Nut Socket

For BMW E24, E28, E32, & E34, & Audi & VW Type 2.  
 Sale \$32.19 **Tool Club \$25.75**



### CTA4146 BMW Front Wheel Hub Bearing Nut Socket

46mm x 12 PT x 3/4" drive.  
 Sale \$37.44 **Tool Club \$29.95**



## LUG NUT FLIP SOCKET

**NEW!**

Part #	Size	Sale	Club
CTA4221	18.5 x 19.5mm	\$19.06	\$15.25
CTA1799	21 x 21.5mm	\$17.81	\$14.25
CTA4222	22 x 22.5mm	\$19.94	\$15.95

### CTA4218 Mercedes Lug Nut Socket

17mm x 6 PT "Flower Design". '09 and up. Plastic sleeve protects rims.  
 Sale \$27.19 **Tool Club \$21.75**



### SUN2714 17mm Covex Extra Thin Mercedes Wheel Lug Socket

For flower head design on late model Mercedes S, GLK, and CL class.  
 Sale \$25.94 **Tool Club \$20.75**



### CTA7307 7pc Flip Socket Set

Sizes: 17mm x 17.5mm, 18.5mm x 19.5mm, 19mm x 21mm, 21mm x 21.5mm, 22mm x 22.5mm, 27mm x 27.7mm, 1/2" Dr. Ext.  
 Sale \$99.94 **Tool Club \$79.95**



### AST7870 7pc Chrome Protective Plastic Sleeve Socket Set

Sizes Include: 13/16", 7/8", 1", 1-1/16", 17mm, 19mm, 21mm. Hollow design creates room for removing longer bolts by pushing out plastic insert  
 Sale \$71.88 **Tool Club \$57.50**



## BUDD WHEEL

### SUN4626 3/4" Dr. Combination Budd Wheel Set

41 x 21mm (4121C), 33mm Deep Impact Socket (433MD), 35 x 17mm Budd Wheel (43517B), 1-1/2 x 13/16" Budd Wheel  
 Sale \$149.94 **Tool Club \$119.95**

**NEW!**



### SUN5626 1" Dr. Budd Wheel Set

1-1/2" x 13/16", 35mm x 17mm, 38mm x 20mm, 41mm x 21mm, & deep 33mm socket.  
 Sale \$201.88  
**Tool Club \$161.50**



## 6 PT AXLE SOCKETS

### SUN2839 7pc Spindle Nut Set

Sizes: 29, 30, 32, 34-36 & 38mm.  
 Sales Price \$127.19  
**Tool Club \$101.75**



### AME37330 Hub Buddy Impact Lug / Hub Surface Cleaner

Use with 1/2" impact wrench. Removes rust and corrosion.  
 Sale \$45.63 **Tool Club \$36.50**



### AME37335 Disc Refill Pack

Sale \$48.44 **Tool Club \$38.75**



### AME67300 Nut Buddy Lugnut Buster

Busts loose stubborn lugnuts. Rated output torque: 2,950 ft/lbs. Includes two sockets (1-1/2" & 1-5/16") and extension.  
 Sale \$171.88 **Tool Club \$137.50**



### AME67301 Nut Buddy Junior

Rated output torque: 885 ft/lbs. Includes sockets (17, 19, 21mm).  
 Sale \$131.19 **Tool Club \$104.95**



### AME67800 3pc Spline Plus "Six-Way" Socket Set

Sizes: 17mm, 19mm & 21mm. Works on at least 6 different fastener types.  
 Sale \$49.94 **Tool Club \$39.95**



### AME68025 3pc SUV & Light Truck Spline Plus Socket Set

Sizes: 22mm, 7/8" & 15/16". 1/2" drive impact rated. Color coded protective sleeves. Works on at least 6 different fastener types.  
 Sale \$74.94 **Tool Club \$59.95**



### SUN5690A 10pc SAE & METRIC

Deep: 33mm, 1", 1-3/16" & 1-3/4"; Thin wall deep: 1-1/16", 1-1/8" & 1-1/4"; Square: 13/16" & 15/16"; Controlled depth: 1-1/2".  
 Sale \$254.06 **Tool Club \$203.25**



### SUN433MXL 3/4" Dr. 33mm X-Long Socket - 9" Long

Sale \$70.00 **Tool Club \$56.00**



### SUN533MEL 1" Dr. 33mm X-Long Socket - 10" Long

Sale \$118.13 **Tool Club \$94.50**



## SPINDLE NUT

## GW GEARWRENCH



### KDT41660D 6pc 1/2" Dr. Spindle Nut Service Kit

For most 4WD SUV and light truck axle locknut applications.  
 Sale \$124.94

**Tool Club \$99.95**

### KDT2467 4WD Spindle Nut Wrench

Ford, Chevy, GMC & Dodge.  
 Sale \$33.69  
**Tool Club \$26.95**

### KDT3246D 4WD Spindle Nut Wrench

For Ford F250 / F350.  
 Sale \$61.56  
**Tool Club \$49.25**



## WHEEL LOCK REMOVER



### AGA-WLRT Wheel Lock Removal Tool

Remove high security wheel locks with spinning rings in minutes without the need of a key or damaging the wheel.  
 Sale \$499.94 **Tool Club \$399.95**

### CAL75510 16pc Wheel Lock Master Key Set

Reduces chances of damaging lug nuts or wheels. Designed for removing many OEM & aftermarket specific locking wheel lug nuts.  
 Sale \$105.63 **Tool Club \$84.50**



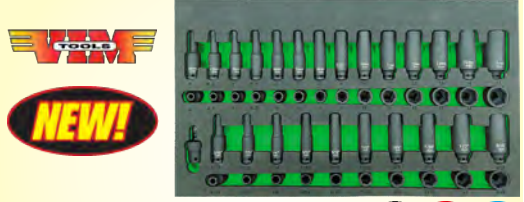

**VIMIMPACT449**  
**49pc 1/4" Impact Socket Set** 1/4 6 PT MM SAE  
 4mm-15mm. 3/16" - 9/16" Short & Deep.  
 Sale \$124.94 **Tool Club \$99.95**

**SUNEX TOOLS**  
**SUN1812**  
**9pc Deep METRIC Set**  
 Sizes: 5.5 - 13mm  
 Sale \$42.81  
**Tool Club \$34.25**



**SUN1820**  
**10pc 1/4" Dr. 6PT SAE**  
**Magnetic Impact Socket Set**  
 Sizes: 3/16" - 9/16"  
 Sale \$54.94 **Tool Club \$43.95**

**1/4" DRIVE IMPACT**

**SUN1848**  
**48pc Master Impact Set**  
**SAE:** 3/16" - 9/16"  
**Metric:** 4 - 15mm  
 Both in standard and deep.  
 Sale \$124.94  
**Tool Club \$99.95**

**SUN1814**  
**12pc METRIC Swivel Set**  
 Sizes: 5 - 15mm  
 Sale \$160.31  
**Tool Club \$128.25**



**SUNEX TOOLS**  
**SUN1874**  
**74pc 1/4" Dr. Master Set**  
 Short: 4 to 15mm, 3/16" to 9/16"  
 Deep: 5.5 to 15mm, 3/16" to 9/16"  
 Swivel: 5 to 15mm, 1/4" to 9/16"  
 Torx: T10, T15, T20, T25, T27 & T30  
 Universal joint, 2", 4" & 6" extensions  
 3/8" adapter.  
 Sale \$374.94 **Tool Club \$299.95**

**1/4" MAGNETIC**

**SUN1822**  
**12pc 1/4" Dr. 6PT METRIC**  
**Magnetic Impact Socket Set**  
 Sizes: 5mm - 15mm  
 Sale \$60.31 **Tool Club \$48.25**

**SUN1825**  
**11pc 1/4" Dr. 12PT METRIC**  
**Magnetic Universal Impact Socket Set**  
 Sizes: 5mm - 15mm  
 Sale \$187.44 **Tool Club \$149.95**

**3/8" DRIVE IMPACT**

**SUNEX TOOLS**  
**SUN3358**  
**13pc METRIC**  
 Sizes: 7 - 19mm  
 Sale \$37.44  
**Tool Club \$29.95**

**SUN3675**  
**13pc METRIC**  
 ALL 12PT  
 Sizes: 7 - 19mm  
 Sale \$47.44  
**Tool Club \$37.95**

**SUN3359**  
**13pc METRIC**  
 Sizes: 7 - 19mm  
 Sale \$60.63  
**Tool Club \$48.50**

**SUN3657**  
**10pc METRIC Swivel**  
 Sizes: 10 - 19mm  
 Sale \$144.06  
**Tool Club \$115.25**

**SUN3691**  
**13pc METRIC Swivel - 12pt**  
 Sizes: 7 - 19mm  
 Sale \$163.44  
**Tool Club \$130.75**

**SUN3329**  
**29pc METRIC Standard/DEEP**  
 Sizes: 8 - 19, 21 & 22mm plus  
 Universal Joint  
 Sale \$144.06  
**Tool Club \$115.25**

**SUN3330**  
**29pc METRIC ALL 12PT Standard/DEEP**  
 Sockets: 8 - 22mm  
 Includes universal joint.  
 Sale \$141.56  
**Tool Club \$113.25**

**SUN3325**  
**25pc SAE Master Set**  
 5/16" - 1" & U-Joint  
 Sale \$144.06  
**Tool Club \$115.25**

**SUN3326**  
**25pc SAE Master Set**  
 ALL 12PT  
 5/16" - 1" & U-Joint  
 Sale \$144.06  
**Tool Club \$115.25**

**SUN3360DD**  
**28pc Master Deep Impact Set**  
**Metric:** 8 to 22mm  
**SAE:** 5/16" - 1"  
 Sale \$141.56  
**Tool Club \$113.25**

**SUN3342**  
**42pc Master Impact Set**  
**SAE:** 5/16" - 3/4"  
**Metric:** 8 to 19mm  
 Short & Deep. Universal joint & 3" Extension  
 Sale \$144.06 **Tool Club \$115.25**

**SUNEX TOOLS**  
**BIGGEST 3/8" IMPACT SET IN ONE BOX!**  
**SUN3580**  
**80pc 3/8" Drive Master Impact Socket Set**  
 Includes SAE, Metric, Short, Deep, Swivel, Torx, E-Torx, Extensions, & Universal Joint.  
 Sale \$331.88 **Tool Club \$265.50**

**1/2" DRIVE IMPACT**

**SUN2653**  
**14pc METRIC**  
 Sizes: 10 - 19, 21, 22, 26 & 27mm  
 Sale \$100.94  
**Tool Club \$80.75**



**SUN2646**  
**26pc METRIC**  
 Sizes: 10 - 36mm  
 Sale \$250.94  
**Tool Club \$200.75**



**SUN2851**  
**12pc 1/2" Dr. 5" Metric**  
**Extra Long Impact Set**  
 Sizes: 13, 14, 15, 16, 17, 18, 19, 20, 21, 22, 23, 24mm.  
 Sale \$274.94  
**Tool Club \$219.95**



**SUN2652**  
**14pc METRIC**  
 Sizes: 10 - 19, 21, 22, 26 & 27mm  
 Sale \$61.19  
**Tool Club \$48.95**



**SUN2672**  
**15pc METRIC**  
**12PT SET**  
 Sizes: 10 - 24mm  
 Sale \$115.44  
**Tool Club \$92.35**



**SUN2852**  
**9pc 1/2" Dr. 5" Metric**  
**Extra Long Impact Set**  
 Sizes: 26, 27, 28, 29, 30, 31, 32, 33, 34mm.  
 Sale \$316.19  
**Tool Club \$252.95**



**SUN2679**  
**13pc METRIC**  
**12PT SET**  
 Sizes: 10 - 19, 21, 22 & 24mm  
 Sale \$61.19  
**Tool Club \$48.95**



**SUN2669**  
**39pc METRIC**  
 Sizes: 9 - 30mm  
 short and deep.  
 Sale \$219.94  
**Tool Club \$175.95**



**SUN2658**  
**10pc METRIC**  
 Deep Swivel  
 Sizes: 10 - 19mm  
 Sale \$187.81  
**Tool Club \$150.25**



**SUN2826**  
**26pc METRIC**  
**12PT SET**  
 Sizes: 10 - 36mm  
 Sale \$158.75  
**Tool Club \$127.00**



**SUN2665**  
**13pc METRIC**  
**Swivel**  
 Sizes: 12 - 24mm  
 Sale \$259.69  
**Tool Club \$207.75**



**SUN5153DD**  
**29pc METRIC & SAE**  
**Deep Impact Set**  
**Metric:**  
 10 - 27mm,  
**SAE:**  
 7/16" to 1-1/4"  
 plus 2 flip sockets.  
 Sale \$199.94  
**Tool Club \$159.95**



**LOW PROFILE SOCKETS**

- Hex shank drive for hand tool use  
 - Low profile design for limited clearance

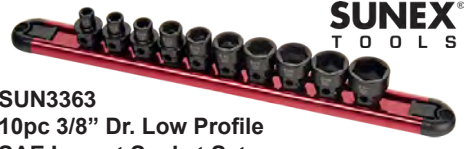

**SUN3363**  
**10pc 3/8" Dr. Low Profile**  
**SAE Impact Socket Set**  
 Sizes: 1/4" - 3/4"  
 Sale \$47.19 **Tool Club \$37.75**



**SUN3362**  
**14pc 3/8" Dr. Low Profile**  
**METRIC Impact Socket Set**  
 Sizes: 6mm - 19mm  
 Sale \$53.69 **Tool Club \$42.95**



**SUN2674**  
**11pc 1/2" Dr. Low Profile**  
**SAE Impact Socket Set**  
 Sizes: 3/8" - 1"  
 Sale \$60.63 **Tool Club \$48.50**



**SUN2673**  
**15pc 1/2" Dr. Low Profile**  
**METRIC Impact Socket Set**  
 Sizes: 10mm - 24mm  
 Sale \$72.50 **Tool Club \$58.00**



**SUN2651**  
**13pc SAE**  
 Sizes: 7/16", 1/2", 9/16", 5/8", 11/16", 3/4", 13/16", 7/8", 15/16", 1", 1-1/16", 1-1/8" & 1-1/4"  
 Sale \$99.69  
**Tool Club \$79.75**



**SUN2678**  
**14pc SAE**  
**12PT SET**  
 Sizes: 7/16", 1/2", 9/16", 5/8", 11/16", 3/4", 13/16", 7/8", 15/16", 1", 1-1/16", 1-1/8", 1-3/16" & 1-1/4"  
 Sale \$80.63  
**Tool Club \$64.50**



**SUN2668**  
**39pc SAE Set**  
 Sizes: 3/8" to 1-1/2"  
 plus universal joint.  
 Sale \$267.44  
**Tool Club \$213.95**



**SUN2698**  
**39pc 1/2" Dr. 12PT SAE**  
**Master Impact Socket Set**  
 Standard Sizes: 3/8" - 1-1/2"  
 Deep Sizes: 3/8" - 1-1/2"  
 Sale \$295.31 **Tool Club \$236.25**



**SUN2699**  
**39pc 1/2" Dr. 12PT METRIC**  
**Master Impact Socket Set**  
 Standard Sizes: 9mm - 30mm  
 Deep Sizes: 9mm - 30mm  
 Sale \$274.94 **Tool Club \$219.95**



**3/8" DRIVE IMPACT**



**SKT4062**  
**12pc METRIC**  
**Short Set**  
 Sizes: 8, 9, 10, 11, 12, 13, 14, 15, 16, 17, 18 & 19mm  
 Sale \$93.69  
**Tool Club \$74.95**



**SKT4058**  
**8pc SAE Short Set**  
 Sizes: 5/16", 3/8", 7/16", 1/2", 9/16", 5/8", 11/16" & 3/4"  
 Sale \$69.38  
**Tool Club \$55.50**



**SKT4082**  
**12pc METRIC**  
**Deep Set**  
 Sizes: 8, 9, 10, 11, 12, 13, 14, 15, 16, 17, 18 & 19mm  
 Sale \$117.44  
**Tool Club \$93.95**



**SKT4078**  
**8pc SAE 6pt. Deep Set**  
 Sizes: 5/16", 3/8", 7/16", 1/2", 9/16", 5/8", 11/16" & 3/4"  
 Sale \$74.94  
**Tool Club \$59.95**



**SKT4090**  
**METRIC/SAE 40pc Master Set**  
**SAE:** 5/16", 3/8", 7/16", 1/2", 9/16", 5/8", 11/16", & 3/4" short and deep sockets  
**METRIC:** 8, 9, 10, 11, 12, 13, 14, 15, 17, 18 and 19mm short and deep sockets  
 Sale \$287.44 **Tool Club \$229.95**

**SKT33351**  
**10pc METRIC**  
**Swivel Set**  
 Sizes: 10, 11, 12, 13, 14, 15, 16, 17, 18 & 19mm  
 Sale \$212.44  
**Tool Club \$169.95**



**SKT33300**  
**8pc SAE**  
**Swivel Set**  
 Sizes: 5/16", 3/8", 7/16", 1/2", 9/16", 5/8", 11/16" & 3/4".  
 Sale \$199.94  
**Tool Club \$159.95**



**1/2" DRIVE IMPACT**

**KDT84918N**  
**15pc Metric**  
**Swivel Set**  
 Sizes: 8, 9, 10, 11, 12, 13, 14, 15, 16, 17, 18, 19, 20, 21 & 22mm.  
 Sale \$174.94  
**Tool Club \$139.95**



**KDT84939N**  
**15pc Metric**  
**Swivel Set**  
 Sizes: 10, 11, 12, 13, 14, 15, 16, 17, 18, 19, 20, 21, 22, 23 & 24mm  
 Sale \$199.94 **Tool Club \$159.95**



**SKT4035**  
**15pc SAE**  
**Short Set**  
 Sizes: 3/8", 7/16", 1/2", 9/16", 5/8", 11/16", 3/4", 13/16", 7/8", 15/16", 1", 1-1/16", 1-3/16" & 1-1/4"  
 Sale \$162.44 **Tool Club \$129.95**



**SKT4036**  
**17pc METRIC**  
**Short Set**  
 Sizes: 8, 9, 10, 11, 12, 13, 14, 15, 16, 17, 18, 19, 20, 21, 22, 23 & 24mm  
 Sale \$162.44 **Tool Club \$129.95**



**SKT4048**  
**15pc METRIC**  
**Deep Set**  
 Sizes: 10mm - 24mm  
 Sale \$219.38  
**Tool Club \$175.50**



**SKT4039**  
**19pc SAE**  
**Short Set**  
 Sizes: 3/8", 7/16", 1/2", 9/16", 5/8", 11/16", 3/4", 13/16", 7/8", 15/16", 1", 1-1/16", 1-1/8", 1-3/16", 1-1/4", 1-5/16", 1-3/8", 1-7/16" & 1-1/2"  
 Sale \$262.44 **Tool Club \$209.95**



**SKT4038**  
**23pc METRIC**  
**Short Set**  
 Sizes: 10mm - 27mm, 29, 30, 32, 36 & 46mm  
 Sale \$281.19 **Tool Club \$224.95**



**SKT4047**  
**26pc METRIC**  
**Deep Set**  
 Sizes: 10 - 30mm, 32, 33, 34, 35 & 36mm  
 Sale \$462.44 **Tool Club \$369.95**



**SKT4049**  
**19pc SAE Deep Set**  
 Sizes: 3/8", 7/16", 1/2", 9/16", 5/8", 11/16", 3/4", 13/16", 7/8", 15/16", 1", 1-1/16", 1-1/8", 1-3/16", 1-1/4", 1-5/16", 1-3/8", 1-7/16", 1-1/2".  
 Sale \$349.94 **Tool Club \$279.95**



**SKT4037**  
**25pc METRIC**  
**Short Set**  
 Sizes: 8mm - 32mm & 36mm.  
 Sale \$274.94 **Tool Club \$219.95**



**SKT34350**  
**15pc METRIC**  
**Swivel Set**  
 Sizes: 10mm - 24mm  
 Sale \$437.44  
**Tool Club \$349.95**



**SKT4053**  
**30pc METRIC**  
**Master Set**  
 Short: 8mm - 24mm  
 Deep: 10mm - 24mm  
 Sale \$306.19 **Tool Club \$244.95**



**SKT4051**  
**28pc SAE Master Set**  
 Short & Deep: 3/8", 7/16", 1/2", 9/16", 5/8", 11/16", 3/4", 13/16", 7/8", 15/16", 1", 1-1/16", 1-1/8", 1-1/4"  
 Sale \$312.44 **Tool Club \$249.95**





**SUN4687**  
9pc 3/4" Dr. 12pt **SAE** Impact Socket Set  
Sizes: 3/4", 13/16", 7/8", 15/16",  
1", 1-1/8", 1-3/16" and 1-1/4".  
Sale \$158.75 **Tool Club \$127.<sup>00</sup>**



**3/4" DRIVE IMPACT**

**SUN4680**  
8pc **SAE**  
Sizes: 1" to 1-1/2".  
Sale \$109.06  
**Tool Club \$87.<sup>25</sup>**



**SUN4684**  
17pc 3/4" Dr. H.D. **METRIC** Socket Set  
Sizes: 26mm - 46mm  
Sale \$343.69  
**Tool Club \$274.<sup>95</sup>**



**SUN4683**  
17pc **SAE**  
Large Sizes  
1" to 2"  
Sale \$412.44  
**Tool Club \$329.<sup>95</sup>**



**SUN4686**  
17pc 3/4" Dr. Deep **METRIC** Socket Set  
Sizes: 26mm - 44mm  
Sale \$549.94  
**Tool Club \$439.<sup>95</sup>**



**SUN4681**  
8pc **SAE** Deep  
Sizes: 1", 1-1/16",  
1-1/8", 1-1/4",  
1-5/16", 1-3/8",  
1-7/16" & 1-1/2"  
Sale \$137.44  
**Tool Club \$109.<sup>95</sup>**



**SUN4692**  
26pc **METRIC**  
Sizes: 19 - 36,  
46 & 50mm.  
Sale \$412.44  
**Tool Club \$329.<sup>95</sup>**



**SUN4632**  
11pc Wheel  
Service Impact  
Socket Set  
6PT: 3/4", 13/16", 7/8", 1", 1-3/16", 33mm  
Thin Wall Deep: 1-1/16", 1-1/8", 1-1/4"  
Deep Budd Wheel: 1-1/2"  
Square Drive: 13/16"  
Sale \$216.56 **Tool Club \$173.<sup>25</sup>**



**SUN4693**  
26pc **METRIC** Deep  
Sizes: 19 - 36,  
46 & 50mm. 6 point.  
In blow molded case.  
Sale \$537.44  
**Tool Club \$429.<sup>95</sup>**



**GRY9026MD**  
26pc 1" **METRIC** Deep Impact Set  
Sizes: 17, 19, 21, 22, 23, 24, 26, 27, 28, 29,  
30, 32, 33, 34, 35, 36, 38, 41, 42, & 46mm.  
Sale \$1,099.94 **Tool Club \$879.<sup>95</sup>**



**GRY9020MD**  
20pc 1" **METRIC** Deep Impact Set  
Sizes: 45, 46, 47, 48, 50, 51, 52, 53, 54, 55,  
56, 57, 58, 60, 62, 63, 65, 67, 70, 75mm.  
Sale \$2,249.94 **Tool Club \$1,799.<sup>95</sup>**



**SUNEX**  
TOOLS

**SUN5697M**  
1" Dr. Metric Deep  
Impact Socket Set  
Set includes 1" Dr. Metric Deep Impact Socket Set (536MD), 1" Dr. Metric Deep Impact Socket Set (541MD), 1" Dr. 17mm Double Square Impact Socket(517MSS), 1" Dr. 21mm Double Square Impact Socket(521MSS), 1" Dr. 27mm Deep Impact Socket(527MD), 1" Dr. 33mm Deep Impact Socket(533MD), 1" Dr. 35mm Deep Impact (535MD)  
Sale \$199.94 **Tool Club \$159.<sup>95</sup>**



**NEW!**



**SUN5616**  
1" Dr. 14pc **SAE** Impact Socket Set  
Set includes 1" Dr. 2-1/16" Impact Socket(566), 1" Dr. 2-1/8" Impact Socket(568), 1" Dr. 2-3/16" Impact Socket(570), 1" Dr. 2-5/16" Impact Socket(574), 1" Dr. 2-3/8" Impact Socket(576), 1" Dr. 2-1/2" Impact Socket  
Sale \$962.44 **Tool Club \$769.<sup>95</sup>**

**SUNEX**  
TOOLS **IMPACT SOCKETS**  
**LIFETIME WARRANTY!**



**SUN4696** 3/4" 6 PT SAE  
29pc 3/4" **SAE** Short Set  
3/4, 13/16, 7/8, 15/16, 1, 1-1/16, 1-1/8, 1-3/16,  
1-1/4, 1-5/16, 1-3/8, 1-7/16, 1-1/2, 1-9/16, 1-5/8,  
1-11/16, 1-3/4, 1-13/16, 1-7/8, 1-15/16, 2, 2-1/16,  
2-1/8, 2-3/16, 2-1/4, 2-5/16, 2-3/8, 2-7/16, 2-1/2".  
Sale \$707.44 **Tool Club \$565.<sup>95</sup>**



CASE WITH  
WHEELS

**SUN4695**  
29pc 3/4" **SAE**  
All deep sockets.  
Sizes: 3/4" to 2-1/2".  
Sale \$852.44  
**Tool Club \$681.<sup>95</sup>**



**1" DRIVE IMPACT**



**SUNEX**  
TOOLS

**SUN5692** 1" 6 PT SAE  
21pc 1" Dr. **SAE**  
Impact Socket Set  
Set includes in SAE - inches: 3/4, 13/16, 7/8,  
15/16, 1, 1-1/16, 1-1/8, 1-3/16, 1-1/4, 1-5/16,  
1-3/8, 1-7/16, 1-1/2, 1-9/16, 1-5/8, 1-11/16,  
1-3/4, 1-13/16, 1-7/8, 1-15/16, 2  
Sale \$449.94 **Tool Club \$359.<sup>95</sup>**



**SUNEX**  
TOOLS



CASE WITH  
WHEELS

**SUN5693** 1" 6 PT SAE  
21pc 1" Dr. **SAE** Deep Impact  
Set includes in SAE - inches: 3/4, 13/16, 7/8,  
15/16, 1, 1-1/16, 1-1/8, 1-3/16, 1-1/4, 1-5/16,  
1-3/8, 1-7/16, 1-1/2, 1-9/16, 1-5/8, 1-11/16,  
1-3/4, 1-13/16, 1-7/8, 1-15/16, 2  
Sale \$624.94 **Tool Club \$499.<sup>95</sup>**



## IMPACT UNIVERSAL JOINTS

SUN3305

5pc, 3/8" & 1/2" Drive Adapter & Impact Universal Joint Set  
1/2" & 3/8" Dr. Universals,  
3/8"F x 1/2"M Adapter,  
1/2"F x 3/8"M Adapter, &  
1/2"F x 3/4"M Adapter  
Sale \$64.94  
**Tool Club \$51.95**



TIT40000

8pc Impact Adapter Set  
1"F x 3/4"M,  
3/4"F x 1/2"M,  
1/2"F x 3/8"M, 1/4"F x 3/8"M, 3/8"F x 1/2"M,  
1/2"F x 3/4"M & 3/4"F x 1"M  
Sale \$62.44 **Tool Club \$49.95**

**TITAN**

TIT81483

17pc Impact Adapter & Wobble Extension Set  
1/4", 3/8" & 1/2" U-Joints,  
9 extensions & multiple  
1/4", 3/8" & 1/2" adapters.  
Sale \$69.94 **Tool Club \$55.95**



SUN2343

Super Reducer Adapter Set  
1/2"F x 3/8"M,  
3/8"F x 1/4"M  
& 3/4"F x 1/2"M  
Sale \$43.69  
**Tool Club \$34.95**



SKT45674

3/8" Drive  
3pc Extension Set  
Sizes: 3", 6" & 10"  
Sale \$62.44  
**Tool Club \$49.95**



SKT46164

4pc 1/2" Dr. Impact  
Extension Set  
Sizes: 2", 3", 5" & 10".  
Sale \$91.88  
**Tool Club \$73.50**



TIT42173

3pc 1/2" Dr.  
X- Long Impact  
Extension Set  
Sizes: 18", 24", & 36".  
Sale \$85.94  
**Tool Club \$68.75**

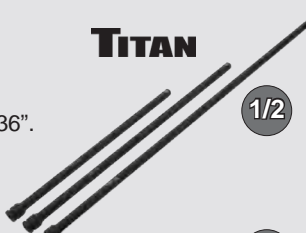

SUN2504

4pc 1/2" Drive Wobble  
Extension Impact Set  
Sizes: 3", 5", 10" & 15". Wobble  
drive provides 15° offset.  
Sale \$61.25  
**Tool Club \$49.00**



## EXTENSION SETS

SUN3500

4pc 3/8" Dr.  
Extension Set  
Sizes: 3", 5", 10" & 15"  
Sale \$74.38  
**Tool Club \$59.50**



SUN2500

4pc 1/2" Dr.  
Extension Set  
Sizes: 3", 5", 10" & 15"  
Sale \$84.38  
**Tool Club \$67.50**



SUN3501

3pc 3/8" Drive Locking  
Impact Extension Kit  
Sizes: 3", 6", 12".  
Sale \$71.56 **Tool Club \$57.25**



## 1/2" DR. EXTENSIONS

Part #	Length	Sale	Club
SKT46169	2"	\$18.69	\$14.95
SKT46170	3"	\$22.44	\$17.95
SKT46171	5"	\$28.13	\$22.50
SKT46172	10"	\$33.13	\$26.50
SKT46174	23"	\$46.19	\$36.95
SKT46175	35" for 1/2"F x 3/8"M transmission	\$64.94	\$51.95
SUN2503	3"	\$11.25	\$9.00
SUN2505	5"	\$15.94	\$12.75
SUN2510	10"	\$26.69	\$21.35
SUN2515	15"	\$40.00	\$32.00
SUN2524	24"	\$57.81	\$46.25
SUN2536	36"	\$71.88	\$57.50
SUN2536T	36" for 1/2"F x 3/8"M transmission	\$78.69	\$62.95

## 3/4" DR. EXTENSIONS

Part #	Length	Sale	Club
SUN4302	6"	\$28.75	\$23.00
SUN4310	10"	\$38.44	\$30.75
SUN4313	13"	\$50.63	\$40.50

## 1" DR. EXTENSIONS

Part #	Length	Sale	Club
SUN5300	6"	\$51.19	\$40.95
SUN5310	10"	\$57.81	\$46.25
SUN5313	13"	\$65.63	\$52.50

## IMPACT UNIVERSAL JOINTS

**SK**  
PROFESSIONAL TOOLS

**SUNEX**  
TOOLS

Part #	Size	Sale	Club
SKT33990	3/8"	\$41.19	\$32.95
SKT34990	1/2"	\$45.63	\$36.50
SUN1800	1/4"	\$12.81	\$10.25
SUN3301	3/8"	\$19.19	\$15.35
SUN2300	1/2"	\$26.88	\$21.50
SUN4304	3/4"	\$57.81	\$46.25
SUN5304	1"	\$80.00	\$64.00

## DRIVELINE SOCKETS

SUN2696

7pc SAE Driveline  
Sizes: 5/16", 3/8",  
7/16", 1/2", 9/16",  
11/16" & 3/4"  
Sale \$201.88  
**Tool Club \$161.50**



SUN2695

9pc Metric  
Driveline  
Sizes: 8mm,  
10mm - 17mm  
Sale \$243.13  
**Tool Club \$194.50**



SUN212ZUMDL

12mm Ford Driveline  
Impact Socket  
Sale \$41.19  
**Tool Club \$32.95**



## IMPACT ADAPTERS



Part #	Size	Sale	Club
SKT45684	3/8"F x 1/2"M	\$23.13	\$18.50
SKT45685	1/2"F x 3/8"M	\$21.88	\$17.50
SKT46184	1/2"F x 3/4"M	\$22.44	\$17.95
SKT46186	1/2"F x 3/4"M w/ball retainer	\$22.44	\$17.95
SKT84607	3/4"F x 1"M	\$53.69	\$42.95
SKT84609A	3/4"F x 1/2"M	\$49.94	\$39.95
SUN3303	3/8"F x 1/4"M	\$11.69	\$9.35
SUN3300	3/8"F x 1/2"M	\$10.94	\$8.75
SUN2303	1/2"F x 3/8"M	\$19.38	\$15.50
SUN4305	3/4"F x 1/2"M	\$31.88	\$25.50
SUN4300	3/4"F x 1"M	\$26.56	\$21.25
SUN5305	1"F x 3/4"M	\$45.94	\$36.75

## CORDED

**BAYSL2135**  
**1,200 Lumen Corded LED**  
**Work Light with Magnetic Hook**  
 Two Brightness Settings: 1,200 & 600 Lumens. Two built in magnets. Included magnetic hook can be attached to either of the built in magnets. 25ft cord.  
 Sale \$90.31 **Tool Club \$72.25**



**WILW2240**  
**1200+ Lumen LED Drop Light**  
 Over 1,200 Lumens of bright white light. Impact resistant handle with rubber grip & magnetic bracket. Powder coated metal lamp shield with swivel hang hook.  
 Sale \$43.69 **Tool Club \$34.95**



**WILW2237**  
**120V LED Drop Light**  
 1000 Lumens. 25ft 18GA grounded cord. Impact resistant handle w/ non-slip rubber grip. Powder coated lamp shield w/ swivel hang hook.  
 Sale \$37.44 **Tool Club \$29.95**



**WILW2402**  
**Wide Angle LED Work Light**  
 2,000+ Lumens.  
 SMD LED technology - stays cool to the touch! Wide angle LEDs. 16ft power cable.  
 Sale \$73.13 **Tool Club \$58.50**



**BAYSL1514**  
**LED Single Fixture Work Light with Magnetic Base**  
 2,200 Lumens. 20W LED. Powerful magnetic base. Multi-angle tilt and swivel. Multi-fin heat sink keeps light cool to the touch. 50,000 Hours of life. Tempered glass lens. 12ft cord.  
 Sale \$93.13 **Tool Club \$74.50**



**BAYSL204**  
**Replacement Incandescent Work Light Head w/ Metal Guard**  
 Replacement incandescent work light head w/ metal guard & single outlet that fits the following models: 450 & 840.  
 Sale \$9.38 **Tool Club \$7.50**



**WILW2282**  
**12W 120V LED Light Bulb**  
 1,200 Lumens. Equivalent to a 75W bulb and fits most standard sockets.  
 Sale \$9.38 **Tool Club \$7.50**



**BAYSL725**  
**25' Extension Cord w/ Single Outlet**  
 25 foot length cord with a 16/3 gauge SJTW cold weather-rated cord rated at 13 amps  
 Sale \$22.44 **Tool Club \$17.95**



**BAYSL750**  
**50' Extension Cord w/ Single Outlet**  
 50 foot length cord with a 16/3 gauge SJTW cold weather-rated cord rated at 13 amps  
 Sale \$42.44 **Tool Club \$33.95**



## REELS

**BAYSL827**  
**13w Fluorescent Work Light on 50ft Metal Reel**  
 This model is a fluorescent work light with nylon tipped double hooks attached to a heavy-duty metal reel with 50ft of retractable 18/2 SVT cord. Cool running 13W fluorescent bulb rated at 10,000 hours of use.  
 Sale \$99.94 **Tool Club \$79.95**



**BAYSL851**  
**Incandescent Work Light with Metal Guard on 50ft Metal Reel**  
 Metal bulb guard with integrated rubber-tipped hook. Rated to handle up to a 75W incandescent bulb (not included). Flame retardant polypropylene handle. Attached to a 50ft retractable cord inside of a metal reel. Includes mounting brackets for attaching the reel to the wall or ceiling.  
 Sale \$82.19 **Tool Club \$65.75**



**BAYSL866**  
**1,200 Lumen LED Work Light with Magnetic Hook on Retractable Reel**  
 Two brightness settings: 1,200 & 600 Lumens. Attached to 50ft of 18/2 SVT cord inside a retractable metal reel.  
 Sale \$145.63 **Tool Club \$116.50**



**BAYSL425A**  
**Incandescent Work Light with Metal Guard & Single Outlet**  
 Polarized plug with 12-amp grounded receptacle. Rated for up to a 75W incandescent bulb (not included). 25ft cord.  
 Sale \$30.63 **Tool Club \$24.50**



**BAYCO**  
 PRODUCTS INC.

**BAYSL426A**  
**Incandescent Work Light with Metal Guard & Single Outlet**  
 Polarized plug with 12-amp grounded receptacle. Rated for up to a 75W incandescent bulb (not included). 50ft cord.  
 Sale \$51.88 **Tool Club \$41.50**



**NEB-OTH-0001**  
**High Bright 6000™**  
 6,000 Lumen Utility Light. 90° adjustable LED Panels. Quick & easy installation. 600% more light than a standard 60W bulb. Energy efficient - only 60W! Standard screw base.  
 Sale \$48.69 **Tool Club \$38.95**



## CORDLESS



**EZRXL5500-RD - Red**  
**EZRXL5500-BL - Blue**  
**EZRXL5500-OR - Orange**  
**COB Xtreme Light - USB Rechargeable**  
 3W COB LED. 500 lumens high. 12" long. 250 lumens low. Up to 3 hours life on high. 6 continuous hours on low.  
 Sale \$71.19 **Tool Club \$56.95**



**MLW2366-20**  
**M18™ ROVER™**  
**Dual Power Flood Light - TOOL ONLY**  
 4,000 Lumens TRUEVIEW™ HD Output. Up to 12 hours of run-time with XC5.0 battery. 120° rotating light head. IP54 water & dust resistant. Impact-Resistant lens. Can also be powered by a 120V AC extension cord.  
 Sale \$168.74 **Tool Club \$134.99**



## UNDERHOOD LIGHTS

**MLW2126-21XC**  
**M12™ Underbody Light Kit**  
 1,200 Lumens of TRUEVIEW™ HD output. 3 power modes for up to 15 hours of run-time. Magnetic base for mounting. 12" magnetic storage tray to hold nuts & bolts.  
 Sale \$349.94 **Tool Club \$279.95**



**MLW2126-20**  
**M12™ Underbody Light - TOOL ONLY**  
 Sale \$249.94 **Tool Club \$199.95**



**MLW2125-21XC**  
**M12 Underhood Light**  
 1,350 lumens. Extends from 47" - 78" long. Up to 8 hours runtime. Includes light, M12 extended battery, & charger.  
 Sale \$312.44 **Tool Club \$249.95**



**MLW2125-20**  
**M12 Underhood Light - TOOL ONLY**  
 Sale \$249.94 **Tool Club \$199.95**



**AST151SL**  
**Rechargeable Slim Aluminum Underhood Light**  
 1510 lumens. Hooks adjust from 45.5" - 82". Independent swivel tension hooks allows you to point the light where you need it. 500 - 1510 lumens w/ power button dimming function. 2.5-6 hour run time. Impact & water resistant IK07 & IP54.  
 Sale \$144.38 **Tool Club \$115.50**





**Astro Pneumatic**

**AST80SL**  
**800 Lumen Rechargeable Slim Light with Quick-Swap System**  
 Dual COB LED 800 Lumen main light with thumb wheel adjustment. 150 Lumen top flashlight. Includes (1) 2,600mAh battery & (1) 4,500mAh battery, high output wall adapter, cable and charging base.  
 Sale \$112.44 **Tool Club \$89.95**

**AST72SL**  
**720 Lumen Rechargeable LED USB-C Slim Light**  
 720 lumen adjustable COB LED light w/ top flashlight & new XL 3,350mAh battery. USB-C 2X Quick Charge. Steel ball swivel base with 20lb magnet & ratcheting extendable base hook. Lasts 3.5 hours on high, 8 hours at 50%.  
 Sale \$85.63 **Tool Club \$68.50**

**AST52SL**  
**500x2 Lumen Wirelessly Rechargeable Folding Double-Sided LED Slim Light**  
 Front & Back Lights each 500 Lumens, total 1000 Lumens. 4,400mAh battery for 3.25+ hours on high. Includes USB-C charging cable and adapter. Features 180° folding design.  
 Sale \$68.69 **Tool Club \$54.95**

**EZRNK10**  
**ANYWHERE™ Neck Light**  
 200 Lumens. 2 AA Batteries. 70° Arc flexible adjusting. 2.5 hour run time.  
 Sale \$33.13  
**Tool Club \$26.50**

**EZRNK15**  
**ANYWHERE™ Neck Light**  
 300 Lumens. USB rechargeable. 70° Arc flexible adjusting. 2.5 hour run time.  
 Sale \$62.44  
**Tool Club \$49.95**

**NEB-POC-0005**  
**Inspector™ RC Penlight**  
 Powerful 360 lumen rechargeable & waterproof.  
 Sale \$38.69 **Tool Club \$30.95**



**NEB-KEY-0003**  
**MYCRO™**  
 TURBO: 400 lumens  
 High: 150 lumens  
 Low: 15 lumens  
 Green & Red  
 Features 6 unique light modes  
 Sale \$37.44 **Tool Club \$29.95**



**NEW!**

**MXN00810**  
**WorkStar Cyclops LED Light - Red**  
 Square array of 9 LEDs & a wide angle lens for a perfectly round beam pattern. 420 lumens. USB-C rechargeable.  
 Sale \$39.38 **Tool Club \$31.50**



**MXN00811**  
**WorkStar Cyclops LED Light - Green**  
 Square array of 9 LEDs & a wide angle lens for a perfectly round beam pattern. 420 lumens. USB-C rechargeable.  
 Sale \$39.38 **Tool Club \$31.50**



**MXN00812**  
**WorkStar Cyclops LED Light - Yellow**  
 Square array of 9 LEDs & a wide angle lens for a perfectly round beam pattern. 420 lumens. USB-C rechargeable.  
 Sale \$39.38 **Tool Club \$31.50**



**MXN00900**  
**MAXXBEAM Zoom Work Light**  
 300, 600 or 1200 Lumens. USB-C rechargeable battery. 2 - 11 hour run time. 6X zoom adjustable focus. Max range of 656ft.  
 Sale \$93.69 **Tool Club \$74.95**



**KKLNC1541**  
**COB LED Work Light**  
 500 lumens. 60 lumen focus beam. Swivel handle rotates 180° and features a magnetic backing.  
 Sale \$66.19 **Tool Club \$52.95**



**EZRSPR200BK**  
**Micro-USB Rechargeable Pocket Spot Light**  
 200 lumens. Magnetic base. 6 hour runtime.  
 Sale \$37.44 **Tool Club \$29.95**



**NEB-WLT-0005**  
**SLIM+ Rechargeable Pocket Light**  
 700 lumens. Red laser pointer. Acts as a power bank. 1.5 - 6 hour runtime. 20 hour red laser runtime.  
 Sale \$43.69 **Tool Club \$34.95**



**NEB-FLT-0001**  
**TORCHY Compact Rechargeable Flashlight**  
 4 light modes: High (500 Lumens), Medium (200 Lumens), Low (50 Lumens), Strobe (500 Lumens) & TURBO (1,000 Lumens)  
 Sale \$38.69 **Tool Club \$30.95**



**NEB-FLT-0003**  
**Redline® FLEX**  
 Can be powered with Li-Ion Battery (included) OR with a single AA battery. 250 Lumens on High or 450 Lumens in TURBO mode.  
 Sale \$28.69 **Tool Club \$22.95**



**NEB-FLT-0009**  
**Redline® BLAST RC**  
 3,200 Lumens on High.  
 Sale \$99.94 **Tool Club \$79.95**



**MXN05200**  
**LUMENATOR Jr. Rechargeable LED Work Light**  
 1050 Lumens. 10 Watt COB LED. Sealed power switch with 3 brightness levels. Li-ion battery. Run time: 2.5 - 13.5 hours. Light can operate while charging. 180° rotating stand.  
 Sale \$97.44 **Tool Club \$77.95**



**AST70SL**  
**Rechargeable Micro Floodlight**  
 700, 350, or 100 Lumens. 2.5 - 10 hours of worktime. Charge level indicator on back.  
 Sale \$57.44 **Tool Club \$45.95**



**MXN00630**  
**WorkStar® Technician's Rechargeable Headlamp**  
 700 daylight-white lumens. 6X Zoom lens. Rear safety light. Head tilts 90° with 4 indented positions. Front mounted power/brightness switch. 4 LED battery status indicator.  
 Sale \$54.38 **Tool Club \$43.50**



**MXN00500**  
**Workstar® Droid Technician's Rechargeable LED Mini Headlamp**  
 High: 400 lumens, Low: 160 Lumens. Light head aims forward & securely pivots down 72° through 6 indented positions  
 Sale \$37.44 **Tool Club \$29.95**



**NEB-COM-0001**  
**Inspector 500+ & Mycro Headlamp Combo**  
 Inspector 500+: 500 lumens, powered by rechargeable battery or (2) AAA batteries. Mycro: 400 Lumens Turbo, 150 High.  
 Sale \$62.44 **Tool Club \$49.95**



**NEBWLT-0015**  
**OMNI 2K Work Light**  
 2,000 Lumens. Dual COB output with red hazard feature. Six (6) light modes. 4,000 mAh power bank. Rotating magnetic handles. Rotating COB panels. Water & impact-resistant. Battery charging indicator. Includes USB-C charging cable.  
 Sale \$49.94 **Tool Club \$39.95**



**AST100SL**  
**1,000 Lumen Wirelessly Rechargeable Mini LED Flood Light**  
 1000-1,000 lumens. Massive 4,500mAh capacity Li-ion battery for 3-18 hours of runtime. Includes USB-C charging cable & adapter for quick charging or with a wireless charging pad. Features foldable magnetic base, charge level indicator, water & impact resistance.  
 Sale \$62.44 **Tool Club \$49.95**





**SLT61520**  
**BearTrap Rechargeable Area Light**

2,000 Lumen Flood Light.  
 1,000 Lumen Spot Light.  
 Clamps virtually anywhere, magnetic base, hang hook or stands on its own. Rechargeable, continue using while plugged in. IPX4 Water resistant & 1m impact resistance.  
 Sale \$187.44 **Tool Club \$149.<sup>95</sup>**



**NEW!**

**SLT61510**  
**Syclone® Compact Rechargeable Work Light**

400 Lumens.  
 Spot and Flood Light features. Cool White LEDs and 90 CRI LEDs. IPX4 water-resistant. 2 meter impact-resistant. Beam Distance: 141 meters. Head swivels 360° and is adjustable with one hand. Hands-free features: magnetic base or stowable hang-hook.  
 Sale \$69.38 **Tool Club \$55.<sup>50</sup>**



**SLT88810**  
**Wedge™ Slim Everyday Carry Flashlight - Black**  
**SLT88811**  
**Wedge™ Slim Everyday Carry Flashlight - Coyote**

Features 2 lighting modes: Constant on & THRO® mode for maximum brightness. 300 Lumens high; 1,000 Lumens THRO® mode. USB-C rechargeable Lithium Polymer battery. IPX7 waterproof to 1m; 1m impact resistance.  
 Sale \$112.44 **Tool Club \$89.<sup>95</sup>**



**SLT73302**  
**Pocket Mate® Rechargeable Keychain EDC Light**

325 Lumens. High & low modes. USB Rechargeable. Attaches to key chains, zippers, brim of a hat & more for hands-free usage!  
 Sale \$31.19 **Tool Club \$24.<sup>95</sup>**



**NEW!**

**SLT51063**  
**Twin-Task USB Rechargeable Headlamp**

Elastic head strap. IPX4 water resistant. 120° tilting head. Spot & flood capability.  
 Sale \$78.69 **Tool Club \$62.<sup>95</sup>**



**SLT61704 - RED**  
**SLT61705 - BLUE**  
**USB Headlamp**

Low profile, USB rechargeable headlamp. 3 output modes. Up to 180 lumens.  
 Sale \$31.19 **Tool Club \$24.<sup>95</sup>**



**SLT61502**  
**Flipmate USB Rechargeable Multi-Function Compact Work Light**

Cool White LED - 500 Lumens  
 90 CRI LEDs. IPX4 Water Resistant. 2 meter impact resistant.  
 Sale \$95.63 **Tool Club \$76.<sup>50</sup>**



**SLT78100**  
**STINGER® 2020 Rechargeable LED Flashlight - Tool Only**

2,000 Lumens. High, Medium, Low and Strobe modes. IPX7 waterproof. 2m impact resistance tested. Mode switch for easy selection of High, Medium & Low. Includes "Y" USB cord & lanyard.  
 Sale \$170.63 **Tool Club \$136.<sup>50</sup>**



**SLT78101**  
**STINGER® 2020 Rechargeable LED Flashlight with Charging Holder**

2,000 Lumens. High, Medium, Low and Strobe modes. IPX7 waterproof. 2m impact resistance tested. Mode switch for easy selection of High, Medium & Low. Includes "Y" USB cord & lanyard.  
 Sale \$196.88 **Tool Club \$157.<sup>50</sup>**



**SLT66148**  
**Stylus Pro USB UV Penlight**

400nm UV LED w/ 325 mW output. Runs 2.5 hours. Rechargeable lithium ion battery. Water-resistant. IPX4 water resistant. 1 meter impact resistance tested  
 Sale \$77.19 **Tool Club \$61.<sup>75</sup>**



**SLT66140**  
**Stylus Pro USB Rechargeable Penlight**

70 lumens. 3.5 hour runtime. USB Rechargeable Li-ion battery. Water resistant. Blue only.  
 Sale \$69.06 **Tool Club \$55.<sup>25</sup>**



**SLT66118**  
**Stylus Pro® Penlight**

Projects 48 lumens 70 yards. Shockproof C4 LED. IPX4 for water resistance.  
 Sale \$29.69 **Tool Club \$23.<sup>75</sup>**



**SLT66318**  
**MicroStream LED Penlight**

C4 LED technology. IPX4 for water resistance. 52-meter beam lasts up to two hours.  
 Sale \$24.94 **Tool Club \$19.<sup>95</sup>**



**SLT76801**  
**Stinger Switchblade Rechargeable Multi-Function Worklight**

5 lights in 1! Drop light, hands free, white light, color-rite light, and UV light. 180° rotating light bar. Ultra thin design for tight spaces.  
 Sale \$131.19 **Tool Club \$104.<sup>95</sup>**



SLT75494 SLT75486 SLT75488 SLT75492



**SLT75486 (BLUE)**  
**SLT75488 (GREEN)**  
**SLT75494 (RED)**  
**SLT75492 (PURPLE)**

**Stinger DS LED HL with AC/DC Piggy Back Charger 640 Lumens**

- Dual switch technology.
  - Three lighting modes, including strobe
  - 297 meters of beam distance.
  - C4® LED technology, impervious to shock with a 50,000 hour lifetime.
  - 3-cell, 3.6 Volt Ni-MH sub-C battery
  - 10 hr. steady charge, 2.5 hr. fast charge, or PiggyBack charger options.
  - IPX4 water-resistant.
  - Unbreakable polycarbonate lens with scratch-resistant coating.
- Sale \$218.69 **Tool Club \$174.<sup>95</sup>**



SLT74752 SLT74769 SLT74773



**SLT74769 - Lime Green**  
**SLT74752 - Black**  
**SLT74773 - Purple**

**Strion LED Rechargeable Flashlight**

- Three modes and strobe. Lithium Ion battery. Clamp style charger. 500 lumens. High power in compact size. Up to 3.5 hours of runtime on low setting. High mode range up to 200m. Weighs only 5.2oz with battery. Fully recharges in 3 hours. Includes wall and 12v chargers.  
 Sale \$187.44 **Tool Club \$149.<sup>95</sup>**



**SLT75863**  
**Stinger® DS LED HP Rechargeable Flashlight**

Made of aircraft-grade aluminum and coated with slip-resistant rubber. 50,000 hours of life. Dual switch intensity levels and strobe feature. C4 LED technology. 3.6-volt battery is rechargeable up to 1,000 times.  
 Sale \$199.94 **Tool Club \$159.<sup>95</sup>**



## HD REGULATORS

### RELIEVING TYPE REGULATORS

- Offset 1/4" gauge ports serving as two 1/4" supply lines, allowing up to 3 regulated full flow out ports.
- Inlet pressure: 250 PSI • Max SCFM: 80
- Operating temperature: 40°F to 120°F

Part #	NPT	Sale	Club
MIL1113	1/4" NPT	\$69.38	<b>\$55.50</b>
MIL1114	3/8" NPT	\$69.38	<b>\$55.50</b>
MIL1115	1/2" NPT	\$83.13	<b>\$66.50</b>



## RE-KOIL AIR HOSE

- Maximum working pressure: 200 PSI @ 70°F
- Working temp: -40°F to 180°F
- Resists abrasions
- Material: Equivalent to nylon 12
- Full flow male NPT swivel fittings on both ends to avoid twisting and kinking



Part #	ID	Lgth.	Swivel Male NPT	Sale	Club
MIL1669	1/4"	25'	1/4"	\$26.56	<b>\$21.25</b>
MIL1670	1/4"	50'	1/4"	\$46.56	<b>\$37.25</b>
MIL1674	3/8"	25'	3/8"	\$54.94	<b>\$43.95</b>
MIL1674-4	3/8"	25'	1/4"	\$61.56	<b>\$49.25</b>
MIL1675	3/8"	50'	3/8"	\$95.33	<b>\$76.26</b>
MIL1675-4	3/8"	50'	1/4"	\$98.44	<b>\$78.75</b>

**MIL1750**  
**5 in ONE™ Universal Safety Exhaust Quick-Connect Industrial Coupler**  
 1/4" NPT. Accepts all major interchanges: Industrial, High Flow, Automotive, ARO & Lincoln. Safely bleeds off air pressure before releasing connector. Max: 120 PSI. Sale \$23.13 **Tool Club \$18.50**



**IPA8055**  
**3pc Specialty Blow-Gun Asst.**  
 Includes 90° Blow-Gun, Scraper Blow-Gun & Straight Blow-Gun w/ perforated end for bolt holes. Sale \$82.44 **Tool Club \$65.95**



**IPA8091**  
**Flow-Thru System w/ Brush & Venturi**  
 For cleaning, degreasing & application of various solvents. Interchangeable twist-wire stainless steel & industrial-strength nylon brushes. Sale \$199.06 **Tool Club \$159.25**



**IPA8052**  
**Air Comb® Filter & Radiator Cleaner - 36"**  
 90° Multi-Port Air Gun  
 Sale \$54.94 **Tool Club \$43.95**

**IPA8053**  
**Air Comb® Filter & Radiator Cleaner - 48"**  
 90° Multi-Port Air Gun  
 Sale \$60.44 **Tool Club \$48.35**

## FILTERS



METAL BOWL FILTERS ARE FOR HIGH PRESSURE, OVER 140 PSI.

Part #	Size	Sale	Club
MIL1018-8	1/4" NPT	\$82.44	<b>\$65.95</b>
MIL1019-8	3/8" NPT	\$82.44	<b>\$65.95</b>
MIL1020-8	1/2" NPT	\$82.19	<b>\$65.75</b>
MIL1120-8	1/2" NPT	\$109.38	<b>\$87.50</b>
MIL1022-8	3/4" NPT	\$164.38	<b>\$131.50</b>
MIL1122-8	1" NPT	\$187.44	<b>\$149.95</b>



## FILTER/REGULATOR/LUBRICATOR



- Filter removes water
- Regulator maintains pressure
- Lubricator provides oil to the tools
- Complete air management system



Part #	Size	Sale	Club
MILEX45FRL40A-02M	1/4"	\$262.44	<b>\$209.95</b>
MILEX45FRL40A-04M	1/2"	\$262.44	<b>\$209.95</b>

**TA99000**  
**Air Tool Filter**  
 Sale \$19.38  
**Tool Club \$15.50**



**TA98300**  
**Air Regulator w/ Gauge**  
 For paint spraying. Sale \$20.94  
**Tool Club \$16.75**



**TIT19442**  
**In-Line Air Flow Regulator**  
 1/4" NPT. Sale \$8.69  
**Tool Club \$6.95**



**MILS657**  
**1/4" Swivel Connector**  
 Sale \$15.63  
**Tool Club \$12.50**



**DYN95460**  
**1/4" Aluminum Swivel**  
 Sale \$33.69  
**Tool Club \$26.95**



**TIT19327**  
**1/4" NPT Swivel Plug**  
 30° Swivel action. Sale \$8.44  
**Tool Club \$6.75**



**MILS711**  
**1/4" M-Style Air Coupler & Plug Set**  
 Sale \$9.38  
**Tool Club \$7.50**



**MILS745**  
**1/4" NPT Female AMT Style 3-Way Coupler**  
 Sale \$13.69  
**Tool Club \$10.95**



## AIR FILTRATION

**AST2618**  
**Air Control Unit**  
 Large Filter with regulator. 50CFM capacity. 5 Micron filtration. Sale \$124.94  
**Tool Club \$99.95**



**AST2615**  
**3/8" Filter/Regulator with Gauge**  
 2" face. 1/4" or 3/8" NPT with Max 135psi. Sale \$59.69  
**Tool Club \$47.75**



**MIL1072-2**  
**1/2" Jumbo Desiccant Dryer System**  
 Maximum of 250 PSI. Two quart total capacity. 1/2" NPT. Max of 100 CFM. Sale \$749.94  
**Tool Club \$599.95**



**MILS685-4**  
**3 in 1 Air Manifold**  
 1/4" Air Inlet & 3 Outlets. Sale \$15.63  
**Tool Club \$12.50**



## WHIP HOSES

**APAWHIP**  
**3/8" x 24" Rubber Whip Hose**  
 Sale \$14.94  
**Tool Club \$11.95**



**LEGHFZ3806YW2B**  
**3/8" x 6' Swivel Whip Hose 1/4" MNPT**  
 Sale \$18.69  
**Tool Club \$14.95**



**LEGHFZ1206YW3S**  
**1/2" x 6' Swivel Whip Hose 3/8" NPT**  
 Sale \$33.69  
**Tool Club \$26.95**



## HIGH FLOW COUPLERS



**DOUBLE**  
 THE AMOUNT OF AIR FLOW TO YOUR TOOL!



Part #	Size	Sale	Club
LEGA53440FZ-2PK	1/4" 2pc	\$8.13	<b>\$6.50</b>
LEGA53452FZ	1/4" 3pc	\$21.19	<b>\$16.95</b>
LEGA53457FZ	1/4" 7pc	\$39.06	<b>\$31.25</b>
LEGA53458FZ	1/4" 14pc	\$80.63	<b>\$64.50</b>
LEGA53657FZ	3/8" 7pc	\$49.99	<b>\$39.99</b>

## BLOW GUNS

AST1717 - Green  
AST1718 - Orange  
4" Blow Gun

Sale \$12.81  
**Tool Club \$10.25**



With removable rubber tip

AST1715  
13" Blow Gun

Sale \$14.94  
**Tool Club \$11.95**

AST1716  
20" Blow Gun

Sale \$18.13  
**Tool Club \$14.50**

TIT19994  
48" Air Gun & Wand

Zinc Alloy Gun with 30 degree angled aluminum nozzle and rubber tip.

Air inlet: 1/4" NPT

Sale \$22.44  
**Tool Club \$17.95**

LEGAG1500FZKIT  
10pc Blow Gun Kit

Ergonomic gun body for max comfort & control

Sale \$49.99  
**Tool Club \$39.99**

MILS699  
1/4" Female Air Chuck

Sale \$3.13  
**Tool Club \$2.50**

CTA1930  
Straight Lock-On Air Chuck

Sale \$12.44  
**Tool Club \$9.95**

WILW60309  
Digital Dual Head Tire Gauge

Measures 5 - 99 PSI. LED spot for nighttime use. Measures in PSI, BAR, & KPA.

Sale \$24.94 **Tool Club \$19.95**

MILS153  
1/4" NPT Lever Style Blow Gun

11.4 cubic feet per minute. Straight rubber tip.

Sale \$17.44 **Tool Club \$13.95**

MILS148  
1/4" NPT Lever Style Blow Gun

Includes safety nozzle & rubber tip.

Sale \$11.88 **Tool Club \$9.50**

MILS157  
Siphon Spray Blow Gun Kit

For use with liquids only. Includes 8' of tubing. 1/4" NPT.

Sale \$30.31 **Tool Club \$24.25**



MILS690-12  
12" Dual-Head Air Chuck

12-1/4" overall length. Max. pressure: 150 PSI.  
Sale \$19.06 **Tool Club \$15.25**



MILS693-12  
12" Dual-Head Straight Foot Air Chuck

12-3/4" overall length. Max. pressure: 150 PSI  
Sale \$15.31 **Tool Club \$12.25**



MILS690  
Dual Head Chuck

Sale \$18.13 **Tool Club \$14.50**



MILS449  
Tire Valve Tool

Sale \$13.13 **Tool Club \$10.50**



MILS976  
Dual Head Tire Gauge

Range: 10 to 160 lb. Length: 12 3/4"  
Sale \$27.50 **Tool Club \$22.00**



MILS928  
Tractor Tire Gauge

2 sides 5 to 50 PSI & 40 to 350  
Sale \$11.88 **Tool Club \$9.50**



MILS986  
Service Gauge - Straight Foot Dual Head

Length: 13 1/4"  
Sale \$32.44 **Tool Club \$25.95**



CTA1937  
Automotive Tire Gauge

Range: 10 - 50 PSI or 75 - 325 kPa  
Sale \$5.31 **Tool Club \$4.25**



MILEX516DIG  
Digital Tire Gauge

360° swivel chick. Backlit display. Range: 5 - 100psi.  
Sale \$25.63 **Tool Club \$20.50**



MIL501  
Dual Head Straight Chuck Inflator Gauge

Includes 5' hose & deflator valve. 1/4" NPT inlet. Range: 10 - 160 PSI. Full swivel chuck head.

Sale \$107.81 **Tool Club \$86.25**



MILS506  
Dual Head Inflator

With 10 - 120 lb. gauge, 15" hose & swivel head.

Sale \$66.88  
**Tool Club \$53.50**



MILS516  
Straight Head Inflator

With lock-on threads, 15" hose, 10 - 120 lb. gauge & swivel head.

Sale \$74.38  
**Tool Club \$59.50**



## TIRE INFLATORS



MILS580EKIT  
Digital Inflator Gauge Kit

Easy to read display. Display automatically adjusts for left or right-handed use, or vertical "portrait" mode. Auto on/off feature. Deflation button.

High contrast screen, work light, valve cap holder & integrated hang hook. The most accurate tire inflator gauge available anywhere on the market - 0.05 % accuracy. Pressure Range: 0 - 160 PSI (PSI, kPa, Bar & kg/cm2)  
Sale \$337.44 **Tool Club \$269.95**



AST3018  
Digital Inflator

New dual AAA battery powered design. New 21" Stainless braided hose for increased durability. Maximum accuracy & 0.1psi resolution. Displays KG, PSI or BAR measurement. Large face backlit LCD display. Unit covered with rubber sleeve for extra comfort and durability. Two position lever. Easy Change Chuck System. Works with nitrogen systems and CO<sub>2</sub>. Batteries Included  
Sale \$110.63 **Tool Club \$88.50**



AST3081  
Dial Tire Inflator

Inflate, deflate & measure tire pressure. 80mm pressure gauge (0-12 Bar/174PSI). Aluminum die-casting unit covered with a rubber sleeve for extra comfort & durability. 2 position inflate/deflate lever.  
Sale \$65.31  
**Tool Club \$52.25**



MILS568  
H.D. Digital Tire Pressure Gauge & Inflator w/ Lock-On Chuck

Range: 0-255 PSI. Resolution of 0.1 PSI, kPa (0-1800), kg/cm2 (0-18), and Bar (0-18). Digital backlit display. Includes lock-on chuck. Batteries included. Durable 20" rubber air hose.  
Sale \$100.94 **Tool Club \$80.75**



WILW10011  
11 Gallon Portable Air Tank

Standard Schrader-type fill valve. On/Off air adjustment valve. Safety pressure bypass with manual override. Industrial-grade air hose with standard tire air chuck.  
Sale \$98.69  
**Tool Club \$78.95**





## AIR HOSE REELS

**LEGL8652FZ**  
**3/8" x 100' FLEXZILLA**  
**Manual Air Hose Reel**  
 3/8" NPT discharge hose.  
 Working temp -40° to 150° F.  
 Sale \$187.44 **Tool Club \$149.95**



**LEGL8611FZ**  
**3/8" x 50' FLEXZILLA**  
**Automatic Air Hose Reel**  
 1/4" NPT discharge hose.  
 Working temp -40° - 150° F.  
 Metal latching pawl.  
 5' long lead in hose.  
 Sale \$349.94 **Tool Club \$279.95**



**LEGL8250FZ**  
**3/8" x 50' FLEXZILLA**  
**Enclosed Air Hose Reel**  
 Auto retract/ latch mechanism.  
 Swivel mounting bracket.  
 Adjustable hose stopper.  
 Hose locks automatically in 18" intervals.  
 Sale \$181.88 **Tool Club \$145.50**



**LCN83753**  
**3/8" x 50' Automatic Air Hose Reel**  
 • All steel construction  
 • Slotted mounting base  
 • Spring powered automatic recoil  
 • 8 position ratchet system  
 • 5 position adjustable outlet arm  
 Sale \$249.94 **Tool Club \$199.95**



**LCN83754**  
**1/2" x 50' Automatic Air Hose Reel**  
 Sale \$274.94 **Tool Club \$219.95**

• Dual arm frame prevents bending & distortion.  
 • EPDM rubber air hose with Nylon braid reinforcement.

**MIL2760-50D**  
**3/8" x 50' Automatic Air Hose Reel**  
 Sale \$287.44 **Tool Club \$229.95**

**MIL2780-50D**  
**1/2" x 50' Automatic Air Hose Reel**  
 Sale \$334.94 **Tool Club \$267.95**



Premium hybrid PVC/RUBBER air hose with a 300 PSI RATING.  
 Working temp -40°F - 150°F.



Part #	ID x Long	Sale	Club
LEG3825	3/8" x 25'	\$42.44	<b>\$33.95</b>
LEG3850	3/8" x 50'	\$62.44	<b>\$49.95</b>
LEG1225	1/2" x 25'	\$55.63	<b>\$44.50</b>
LEG1250	1/2" x 50'	\$94.38	<b>\$75.50</b>



Premium Red Rubber EPDM. Resistance to heat, ozone & abrasion.

Part #	ID x Long	Sale	Club
APA3825	3/8" x 25'	\$37.44	<b>\$29.95</b>
APA3850	3/8" x 50'	\$64.38	<b>\$51.50</b>
APA1225	1/2" x 25'	\$59.94	<b>\$47.95</b>
APA1250	1/2" x 50'	\$89.94	<b>\$71.95</b>



High strength  
 400 PSI working pressure  
 1600 PSI burst pressure  
 Fitting pull pressure at 240 pounds  
 Ergonomic handle grips on both ends  
 Patented built-in swivels on both ends

Part #	ID x Long	Sale	Club
WHH02173825	3/8" x 25'	\$45.63	<b>\$36.50</b>
WHH02173850	3/8" x 50'	\$68.13	<b>\$54.50</b>
WHH02173800	1/2" x 25'	\$118.75	<b>\$95.00</b>



**WHH-REEL3850**  
**3/8" x 50' Air Hose Retractable Reel**  
 High strength.  
 400 PSI working pressure.  
 1600 PSI burst pressure.  
 Fitting pull pressure at 240 pounds.  
 Ergonomic handle grips on both ends.  
 Patented built-in swivels on both ends.  
 Sale \$170.63 **Tool Club \$136.50**



## WATER HOSE NOZZLES

**TIT11090**  
**Water Hose Nozzle**  
 Fireman style.  
 Sale \$12.44 **Tool Club \$9.95**



**TIT11091**  
**Adjustable Water Hose Nozzle**  
 Sale \$19.94 **Tool Club \$15.95**



**LEGNFZG02-N**  
**Flexzilla Pro Pistol Grip Water Hose Nozzle**  
 Multiple Spray Patterns  
 Sale \$58.69 **Tool Club \$46.95**



**LEGL8344**  
**Levelwind Retractable Garden Hose Reel**  
 5/8" ID x 60' long.  
 7 position locking bracket.  
 Levelwind technology automatically coils hose. Latches every 3' or allows for free run.  
 Sale \$287.44 **Tool Club \$229.95**



## WATER HOSES



**LEGHFZG550YW**  
**5/8" x 50' Flexzilla Garden Hose**  
 All weather flexibility.  
 Lays flat. Kink resistant inner core design.  
 150 PSI working pressure.  
 Sale \$59.69 **Tool Club \$47.75**





# AIR COMPRESSORS

DELIVERS NON-STOP PERFORMANCE!

CALL FOR BEST PRICE

GAS-POWERED

ROTARY SCREW

ELECTRIC START

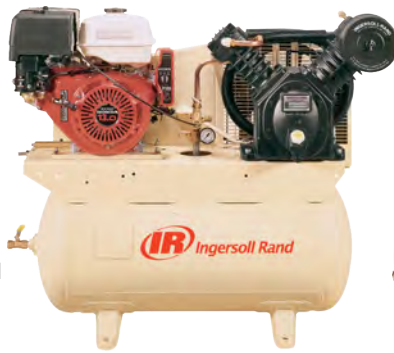

All Compressors Include:

- Two Stage Cast Iron Pumps
- 175 PSI Operation
- Copper Intercooler

Features:

- 100% Cast-iron for durability
- 100% Continuous duty rating
- Designed to run during peak demand
- Two year pump warranty with purchase of start - up kit
- Nationwide service coverage

Part #	HP	Package Description	CFM @ 175 PSI	Tank Size	Voltage or Engine
IR2340L5-V	5	2 stage cast iron pump, finned copper intercooler	14.0	60 gallons	230V
IR7.5HPLOADED	7.5	Automatic drain, low oil level switch, aftercooler, 2 stage cast iron pump, copper intercooler (Deluxe)	24.0	80 gallons	220/230V
IR10HPLOADED	10	Automatic drain, low oil level switch, aftercooler, 2 stage cast iron pump, copper intercooler, magnetic starter (Deluxe), 175 PSI Operation	35.0	120 gallons	220/230V
IR13HPGASHONDA	13	2 stage cast iron pump, copper intercooler	25.0	30 gallons	13HPGAS

**IROILKIT**  
Electric Compressor Oil Kit  
Sale \$212.44  
**Tool Club \$169.<sup>95</sup>**



**IROILMULTIG**  
Gas Compressor Oil Kit  
Sale \$317.58  
**Tool Club \$254.<sup>07</sup>**



**MIL1002-32**  
Air Compressor Oil  
Quart  
Sale \$21.19  
**Tool Club \$16.<sup>95</sup>**



**MIL1002**  
Air Compressor Oil - Gallon  
Sale \$46.19  
**Tool Club \$36.<sup>95</sup>**



## QUIET COMPRESSORS

FEATURES:

- Quiet Technology - low RPM pumps and motors that reduce high frequency noise levels
- Silencer - noise suppression system
- Cool Flow Technology
- Timed Water Drain
- Airstream spacing
- Continuous run (Dual control)
- Totally enclosed fan cooled motor
- Includes 1 year warranty
- Additional warranties available for purchase

**NEW!**

Part #	HP	Tank Size	Sale	Club
LEGFS505V080I1	5	80 gallons	\$5,623.75	<b>\$4,499.<sup>00</sup></b>
LEGFXS07V080V1	7.5	80 gallons	\$6,248.75	<b>\$4,999.<sup>00</sup></b>
LEGFXS10V080V1	10	80 gallons	\$7,123.75	<b>\$5,699.<sup>00</sup></b>
LEGFXS10V120V1	10	120 gallons	\$8,123.75	<b>\$6,499.<sup>00</sup></b>



**COX-P-LP-350**  
Performance Spring Driven  
Hose Reel 3/8" x 50'

Sturdy single pedestal reel with space saving design facilitates workplace organization. Guide arm adjusts to wall, floor, vehicle & overhead positions. Professional grade heavy duty steel construction. Rolled edges & ribbed discs provide strength & safety

Sale \$687.44 **Tool Club \$549.<sup>95</sup>**



**COX-P-LP-450**  
Performance Spring Driven  
Hose Reel 1/2" x 50'

Sturdy single pedestal reel with space saving design facilitates workplace organization. Guide arm adjusts to wall, floor, vehicle & overhead positions. Professional grade heavy duty steel construction. Rolled edges & ribbed discs provide strength & safety

Sale \$749.94 **Tool Club \$599.<sup>95</sup>**



## PORTABLE COMPRESSORS



**LEGCB20200F**  
20 Gallon Portable  
Electric Air Compressor  
2 HP. 125 Max PSI.  
Quiet Technology™.  
Industrial Grade Pump. Front mounted controls. Manual tan drain. 8" over-sized wheels. 6' power cord.  
Sale \$724.94  
**Tool Club \$579.<sup>95</sup>**



**3/8" IMPACT**

**IR15QMAX**  
3/8" Quiet  
Ultra-Compact Impactool  
475 ft/lbs nut busting torque.  
Weighs 2.4 lbs. Quiet  
technology. Only 4.6" long!  
Sale \$228.13  
**Tool Club \$182.<sup>50</sup>**



**ACA1059-VXL**  
3/8" Vibrotherm Drive  
Compact Impact Wrench  
950 ft/lbs of max torque.  
1,300 ft/lbs of loosening torque.  
New Impact Mechanism  
reduces vibration by 30%.  
Weighs 2.8 lbs.  
Sale \$212.44  
**Tool Club \$169.<sup>95</sup>**



**ACA1300-TH-A**  
3/8" Impact Wrench  
500 ft/lbs nut busting  
torque. 450 ft/lbs max  
torque. Composite housing.  
Sale \$237.44  
**Tool Club \$189.<sup>95</sup>**



**IR231C**  
1/2" "The Classic"  
Super Duty Impact  
500 ft/lbs torque forward  
600 ft/lbs reverse.  
Sale \$212.44  
**Tool Club \$169.<sup>95</sup>**



**IR2115TiMAX**  
3/8" "Titanium 'N Torque"  
280 ft/lbs torque in reverse,  
250 ft/lbs forward.  
Sale \$337.44  
**Tool Club \$269.<sup>95</sup>**



**1/2" IMPACT**

**IR36MAX**  
1/2" Ultra-Compact  
Impactool  
625 ft/lbs nut busting torque.  
450 ft/lbs of max torque.  
Weighs 2.4 lbs. Only 4.6"  
long for tight areas!  
Sale \$237.44  
**Tool Club \$189.<sup>95</sup>**



**ACA1058-VXL**  
1/2" Vibrotherm Drive  
Compact Impact Wrench  
500 ft/lbs of max torque.  
Weighs 2.8 lbs. New Impact  
Mechanism recudes vibration  
by 30% & increases life by 50%.  
Sale \$212.44  
**Tool Club \$169.<sup>95</sup>** **NEW!**



**ACA1178-VXL**  
1/2" Vibrotherm Drive  
Compact Impact Wrench  
550 ft/lbs of max torque.  
Weighs 2.8 lbs. New Impact  
Mechanism recudes vibration  
by 30% & increases life by 50%.  
Sale \$306.25  
**Tool Club \$245.<sup>00</sup>**



**OMEGALIFT**  
**OM82002**  
1/2" Impact Wrench  
Twin hammer mechanism  
provides 450 ft/lbs max torque.  
Low vibration for recuded fatigue.  
Sale \$124.94  
**Tool Club \$99.<sup>95</sup>**



**IR2135QXPA**  
1/2" Air Impact Wrench  
1,100 ft/lbs of max torque.  
4 lbs. Quiet technology.  
Sale \$324.94  
**Tool Club \$259.<sup>95</sup>**



**IR2235TiMAX**  
1/2" Titanium  
Impact Wrench  
1,350 ft/lbs of nut-busting torque.  
Weighs only 4.6 lbs!  
Sale \$474.94  
**Tool Club \$379.<sup>95</sup>**



**IR2235TiMAX-G**  
1/2" Titanium  
Impact Wrench  
1,350 ft/lbs of nut-busting torque.  
Weighs only 4.6 lbs!  
Sale \$487.44  
**Tool Club \$389.<sup>95</sup>**



**IR2235TiMAX-R**  
1/2" Titanium  
Impact Wrench  
1,350 ft/lbs of nut-busting torque.  
Weighs only 4.6 lbs!  
Sale \$487.44  
**Tool Club \$389.<sup>95</sup>**



**IR2235QTiMAX**  
1/2" "Quiet" Titanium  
Impact Wrench  
Sound reducing design.  
1300 ft/lbs.  
Sale \$487.44  
**Tool Club \$389.<sup>95</sup>**



**IR2235TiMAX-2**  
1/2" Extended  
Titanium Impact  
Wrench  
2" extended anvil.  
Sale \$487.44  
**Tool Club \$389.<sup>95</sup>**



**3/4" IMPACT**

**IR2145QiMAX**  
3/4" Super  
Duty Impact  
1,350 ft/lbs torque.  
Weighs only 7.4 lbs!  
Sale \$749.94  
**Tool Club \$599.<sup>95</sup>**



**ACA1600-TH-A**  
3/4" Super Duty  
Impact Wrench  
1,600 ft/lbs of max torque.  
Hard hitting "Super Clutch"  
Sale \$499.94  
**Tool Club \$399.<sup>95</sup>**



**IR261**  
3/4" H.D. Impact  
1,200 max ft/lbs torque.  
Sale \$712.44  
**Tool Club \$569.<sup>95</sup>**

AVAILABLE  
IN 3 DIFFERENT  
ANVIL LENGTHS!

Part #	Anvil	Torque	Sale	Club
IR261		1,200	\$712.44	\$569. <sup>95</sup>
IR261-3	3"	1,200	\$787.44	\$629. <sup>95</sup>
IR261-6	6"	1,200	\$837.44	\$669. <sup>95</sup>

**IR** THE NEW  
2235 SERIES!

**LIMITED QUANTITY**



**SUNSX231PBAGPR1**  
5pc Air Tool Kit w/ Accessories  
& FREE Gatemouth Bag  
Includes 1/2" Mini Impact Wrench, 3/8" Air  
Ratchet, 1/4" Dr. Mini Air Die Grinder,  
Utility Cutoff Tool with Guard, 1/4" Dr. Mini Right  
Angle Die Grinder Kit & 4pc 1/2" Dr Deep Thin  
Wall Flip Impact Socket Set.  
Sale \$249.94 **Tool Club \$199.<sup>95</sup>**

## 1" IMPACT

**IR295A**  
**1" Air Impact Wrench**  
 Max Torque: 1,450ft/lbs  
 Deliver Fast Torque  
 at 1,000ft/lbs in 2 seconds  
 Sale \$937.44  
**Tool Club \$749.<sup>95</sup>**



**AST1833**  
**3/8" Nano Flex-Head Angle Impact Wrench**  
 Max Torque: 400ft/lbs.  
 180° flex-head w/ 360° swivel handle.  
 Sale \$216.88 **Tool Club \$173.<sup>50</sup>**



**AST1834**  
**1/2" Nano Flex-Head Angle Impact Wrench**  
 Max Torque: 400ft/lbs.  
 180° flex-head w/ 360° swivel handle.  
 Sale \$216.88 **Tool Club \$173.<sup>50</sup>**



**IR2175MAX**  
**1" Impact Wrench**  
 Max Torque: 2,000 ft/lbs  
 Steel core design lasts longer  
 Sale \$962.<sup>44</sup>  
**Tool Club \$769.<sup>95</sup>**



## 1/4" RATCHETS



**IR1105MAX-D2**  
**1/4" Composite Slim Head**  
 Max Torque: 30 ft/lbs.  
 Free Speed: 300 RPM.  
 Sale \$204.06 **Tool Club \$163.<sup>25</sup>**



## 3/8" RATCHETS

**IR1105MAX-D3**  
**3/8" Titanium Slim Head**  
 Max Torque: 30 ft/lbs.  
 Free Speed: 300 RPM.  
 Sale \$215.63 **Tool Club \$172.<sup>50</sup>**



**SPA7260**  
**1/4" Sealed Flat Head Air Ratchet**  
 Working Torque: 4 - 25 ft/lbs.  
 360° exhaust sleeve. Sealed flat head for long life. Weighs only 1.5 lbs!  
 Sale \$205.31 **Tool Club \$164.<sup>25</sup>**



**SPA7265**  
**3/8" Sealed Flat Head Air Ratchet**  
 Working Torque: 4 - 25 ft/lbs.  
 360° exhaust sleeve. Sealed flat head for long life. Weighs only 1.5 lbs!  
 Sale \$205.31 **Tool Club \$164.<sup>25</sup>**



**IR285B-6**  
**1" Impact**  
 Features 6" extended anvil.  
 1,475 max ft/lbs torque.  
 Sale \$762.44 **Tool Club \$609.<sup>95</sup>**



**IR2850MAX**  
**1" Titanium Impact Wrench**  
 "D" handle. Stubby  
 Max Reverse Torque: 2,100 ft/lbs.  
 Free Speed: 5,500 RPM. 13.1" long.  
 Steel core design. 25% lighter than industry's leading 1" wrench. 360° adjustable handle.  
 Sale \$924.94 **Tool Club \$739.<sup>95</sup>**



**IR105-D2**  
**1/4" Air Ratchet**  
 Max Torque: 25 ft/lbs. Free Speed: 250 RPM.  
 Low profile forward / reverse lever.  
 Sale \$148.44 **Tool Club \$118.<sup>75</sup>**



**IR1207MAX-D3**  
**3/8" MAX Air Ratchet**  
 Max Torque: 65 ft/lbs. Free Speed: 200 RPM.  
 Forward / Reverse collar for easy changes.  
 Sale \$224.94 **Tool Club \$179.<sup>95</sup>**



**IR2850MAX-6**  
**1" Titanium Impact**  
 "D" handle. 6" extended anvil.  
 Max Reverse Torque: 2,100 ft/lbs.  
 Free Speed: 5,500 RPM. 19.1" long.  
 Steel core design. 25% lighter than industry's leading 1" wrench. 360° adjustable handle.  
 Sale \$962.44 **Tool Club \$769.<sup>95</sup>**



**ACA800R**  
**1/4" Composite Air Ratchet**  
 Max Torque: 45 ft/lbs. Free Speed: 320 RPM.  
 Feather trigger for control. Strongest 1/4" ratchet in it's class!  
 Sale \$116.88 **Tool Club \$93.<sup>50</sup>**



**IR107XPA**  
**3/8" Air Ratchet**  
 Max Torque: 54 ft/lbs. Free Speed: 160 RPM.  
 11" long. Variable speed throttle.  
 Sale \$147.81 **Tool Club \$118.<sup>25</sup>**



**ACA1993-VXL**  
**1" Vibrotherm Dr. Impact Wrench w/ 7" Anvil**  
 Provides 2,100 ft-lbs Max Torque. 2,300 ft-lbs of loosening torque. VIBROTHERM DRIVE® impact wrenches incorporates the new patented AIRCAT® design impact wrench mechanism. 6,000 RPM Free Speed.  
 Sale \$749.94 **Tool Club \$599.<sup>95</sup>**



**ACA802R**  
**3/8" Composite Ratchet**  
 Max Torque: 70 ft-lbs. Free Speed: 280 RPM.  
 Feather Trigger for control. Patented quiet tuned exhaust at only 82dBA.  
 Sale \$124.94 **Tool Club \$99.<sup>95</sup>**



**IR109XPA**  
**3/8" High Torque Air Ratchet**  
 Max Torque: 76 ft/lbs. Free Speed: 220 RPM.  
 360° adjustable exhaust.  
 Sale \$218.13 **Tool Club \$174.<sup>50</sup>**



**ACA808-15-25**  
**1/4" Dr. 15.3" Long Reach Ratchet**  
 30 ft-lb Maximum torque (15.3" long).  
 Extended drive shafts provide access for hard to reach fasteners. High grade materials and additional support bearings provide reliability  
 Sale \$149.94 **Tool Club \$119.<sup>95</sup>**



**ACA808-15**  
**3/8" Dr. 15.3" Long Reach Ratchet**  
 30 ft-lb Maximum torque (15.3" long).  
 Extended drive shafts provide access for hard to reach fasteners. High grade materials and additional support bearings provide reliability  
 Sale \$149.94 **Tool Club \$119.<sup>95</sup>**



**CUTTING TOOLS**

SPA7231R

**3" Reversible Flex Head Cut-Off Tool**  
3 position locking flexible head. Reversible throws sparks downward. 12,000 RPM. 8.8" long. Sale \$230.31



**Tool Club \$184.25**

AST209

**ONYX In-Line 3" Cut-Off Tool**  
15,000 RPM. Sale \$114.38



**Tool Club \$91.50**

IR326

**Cut Off Tool**  
18,000 RPM. Sale \$87.44



IR426

**3" Reversible Cut Off Tool**  
20,000 RPM and only 2 lbs! Sale \$136.19



**Tool Club \$108.95**

ACA6275-A

**4" Composite Inside Cut-Off Tool**  
14,000 RPM. 11 position rotational guard. Sale \$274.94



**AIR SAWS**

SPA7610

**Air Recipro Saw**  
Motor driven saw with a powerful stroke. 5,300 strokes per minute. Stroke: 0.47". Sale \$262.44



IR529

**Low Vibration \ Air Reciprocating Saw**  
Small & lightweight design. Adjustable rear exhaust. Sale \$237.44



Includes: **3 fine & 3 coarse tooth blades**

**IR429 Air Saw**

10,000 Strokes/min. Includes 6 Blades. Sale \$147.81



**NEW!**

ACA6355

**Universal Blade Air Saw**  
5,000 SPM. Accepts any saw blade, including "Sawzall" type blades. Can cut up to 1/4" steel or 3" steel pipe. Dual Speed Design. Rear Exhaust. Sale \$237.44



IR4151

**6" Super Duty Dual Action Sander**  
12,000 RPM. Sale \$208.44



**Tool Club \$166.75**

IR311A

**6" Geared Orbital Sander**  
12,000 RPM. Built-in silencer. Sale \$111.19



**Tool Club \$88.95**

IR328B

**8" Dual Action Sander**  
825 RPM. Sale \$199.94



**Tool Club \$159.95**

TIT19225

**6" Orbital Palm Sander**  
For fine finishing. Sale \$93.69



**Tool Club \$74.95**

AST322P

**6" Finishing Palm Sander**  
High power. 3/16" stroke. Orbital action. Sale \$121.19



**Tool Club \$96.95**

**ACA6700-6-336-PSA 6" Orbital Palm Sander**

Lubrication free air motor. Double sealed motor to prevent dust contamination. Anti-Vibration motor design reduces vibration level to 0.8m/sec<sup>2</sup>. Sale \$174.94



**Tool Club \$139.95**

**SHEARS**

IR7802SA

**Air Shear**  
Cuts up to 20 gauge without chips. Shears plastics, aluminum, tin & steel. Sale \$268.69



**Tool Club \$214.95**

**SANDERS AND POLISHERS**



IR315

**Straight Line Sander**  
3,000 strokes per minute. Sale \$178.13

**Tool Club \$142.50**

IR317A

**5" High Speed Sander**  
18,000 RPM. Sale \$107.94



**Tool Club \$86.35**

ACA6320

**Spot Sander**  
13,000 RPM. Only 1lb! Sale \$172.44



**Tool Club \$137.95**

**AIR GRINDER**



IR3445MAX

**4.5" Wheel HD Air Angle Grinder**  
MAX Power: 0.88 horsepower motor 12,000 RPM. Weighs only 3.5lbs! Sale \$387.44

**Tool Club \$309.95**

**LIMITED QUANTITY**

AFF7160

**1/4" Collet HD Mini Die Grinder**  
MAX Power: 0.6HP Motor. 20,000 RPM. Weighs only 1.35lbs! Sale \$48.13



**Tool Club \$38.50**

AFF7200

**3/8" Reversible Drill**  
MAX Power: 0.33HP Motor. 2,200RPM. Weighs only 2.75lbs! Sale \$68.69



**Tool Club \$54.95**

AFF7205

**3/8" HD Reversible Angle Head Drill**  
MAX Power: 0.33HP Motor. 1,700RPM. 3/8" Jacob's Chuck. Sale \$87.44



**Tool Club \$69.95**

AFF7210

**1/2" HD Reversible Air Drill**  
MAX Power: 0.4HP Motor. 800 RPM. Side handle for maximum control & safety. Sale \$99.94



**Tool Club \$79.95**



## 3/8" AIR DRILLS



**IR7802RA**  
**3/8" Reversible HD Air Drill**  
 2,000 RPM. Only 2.5lbs! Quick reverse level, variable speed throttle. Handles smoothly.  
 Sale \$207.44 **Tool Club \$165.95**



**AST525C**  
**3/8" Reversible Air Drill**  
 Lightweight - 2.5lbs. Built-in muffler. 90-120PSI.  
 Sale \$65.31 **Tool Club \$52.25**



**IR7807R**  
**3/8" Reversible Angle Drill**  
 1,800 RPM; Angled for hard to reach places.  
 Sale \$149.94 **Tool Club \$119.95**



**AST510AHT**  
**3/8" Reversible Angle Drill**  
 For hard to reach places. 1,800 RPM. 2 gear drive system.  
 Sale \$104.94 **Tool Club \$83.95**



**IR327**  
**3/8" Air Drill - Tire Buffer**  
 Extra high speed - 22,000 RPM. For recapping, tire scuffing and cleaning tire moldings.  
 Sale \$109.94 **Tool Club \$87.95**

## 1/2" AIR DRILLS



**IR7803RA**  
**1/2" Reversible Air Drill**  
 400 RPM. 4CFM Average Air Consumption. Only 3.3lbs!  
 Sale \$299.94 **Tool Club \$239.95**



Side Handle for Greater Control

**AST527C**  
**1/2" Reversible Air Drill**  
 Variable Speed up to 500 RPM. 9-1/4" Length. 7CFM Average Air Consumption. 90-120 PSI.  
 Sale \$104.94 **Tool Club \$83.95**



## DIE GRINDERS

**IR5102MAX**  
**Angle Die Grinder**  
 0.4 HP air motor. 20,000 RPM free speed. Multi-position head. Spindle lock.  
 Sale \$237.44 **Tool Club \$189.95**



**ACA6295**  
**115° Angle Die Grinder**  
 0.6 HP air motor. 18,000 RPM free speed. Spindle lock. Speed Control.  
 Sale \$137.44 **Tool Club \$109.95**



**IR308B**  
**H. D. Die Grinder**  
 25,000 RPM free speed.  
 Sale \$115.63 **Tool Club \$92.50**



**IR307B**  
**Mini Die Grinder**  
 27,000 RPM free speed.  
 Sale \$78.13 **Tool Club \$62.50**



**IR302B**  
**H. D. Angle Die Grinder**  
 18,000 RPM free speed.  
 Sale \$143.69 **Tool Club \$114.95**



**IR301B**  
**Angle Die Grinder**  
 20,000 RPM free speed.  
 Sale \$91.88 **Tool Club \$73.50**



**ACA6210**  
**1/4" Extended Straight Die Grinder**  
 22,000 RPM free speed.  
 Sale \$187.44 **Tool Club \$149.95**



## DIE GRINDER KITS



**IR301B2MK**  
**Kit for Surface Conditioning**  
 Includes: #301 angle die grinder, 2" & 3" abrasive discs plus holders.  
 Sale \$162.44 **Tool Club \$129.95**



**AST1221**  
**Die Grinder Kit & 8pc. Rotary Burr Set**  
 1/4" 90 Degree Angle Die Grinder (20,000RPM) & 1/4" Mini Die Grinder, (25,000RPM). 8pc. double cut carbide rotary burr set with 1/4" shank.  
 Sale \$149.94 **Tool Club \$119.95**



## ACCESSORIES

### 3" CUT OFF WHEELS

Part #	Pcs.	Club
SH12704	10	\$19.75
SH13215	100	\$89.95
TA94860	5	\$11.50
TA94890	100	\$129.95



### AIR SAW BLADES

NARROW - PACK OF 5



Part #	Lgth.	Teeth	Sale	Club
TA90000	3"	18 T.P.I.	\$18.13	\$14.50
TA90020	3"	24 T.P.I.	\$18.13	\$14.50
TA90030	3"	32 T.P.I.	\$18.13	\$14.50

ALL PURPOSE - PACK OF 5



Part #	Lgth.	Teeth	Sale	Club
TA90010	4"	18 T.P.I.	\$18.13	\$14.50
TA90040	4"	32 T.P.I.	\$18.13	\$14.50

**TA94950**  
**Arbor for Cut Off Wheels**  
 Sale \$9.94 **Tool Club \$7.95**



**SH13056**  
**2" Mini Zirconia Flap Discs**  
 6 Pack  
 Sale \$39.69 **Tool Club \$31.75**



**SH7000**  
**Flap Wheel Kit - 8 Pieces**  
 Sale \$44.06 **Tool Club \$35.25**



**SH13092**  
**4.5" Diamond Cut-Off Wheels**  
 Sale \$41.19 **Tool Club \$32.95**



### ABRASIVE DISCS

Part #	Grit	Club
SH620T	2" Coarse	\$22.50
SH622T	2" Medium	\$22.50
SH624T	2" Fine	\$22.50
SH630T	3" Coarse	\$34.50
SH632T	3" Medium	\$34.50

TWIST-LOCK BAG OF 25



### HOLDERS

Part #	Size	Club
SH13012	2" Holder	\$10.25
SH13013	3" Holder	\$12.00



### SANDING PADS

Part #	Grit	Club
SH13226	2" Coarse - 24	\$23.35
SH13227	2" Medium - 36	\$23.35

BAG OF 25



## AIR HAMMERS

INDIVIDUAL AIR HAMMER CHISELS AVAILABLE!

IR117K

**Air Hammer Kit**

Includes 5 chisels. Up to 2,000 blows per minute. Longer stroke piston. Kit includes edging tool, tail pipe cutter, straight chisel, cutting chisel, and punch. Sale \$114.38 **Tool Club \$91.50**



IR121-K6

**H. D. Air Hammer Kit**

Includes 6 chisels. Professional touch trigger. Up to 3,000 blows per minute. Include blow molded storage case. Sale \$174.94 **Tool Club \$139.95**



ACA5100A

**Composite Medium Stroke Air Hammer Kit**

3,000 Blows Per Minute. Includes H.D. ball-lock quick change chisel retainer, 5 chisels & blow molded case. Sale \$199.94 **Tool Club \$159.95**



IR119MAXX

**Long Barrel Air Hammer Kit**

Includes 5 chisels. Quick change retainer. 2,530 blows per minute. Anti-vibration technology. Includes carrying case. Sale \$224.94 **Tool Club \$179.95**



IR123MAXX

**Short Barrel Air Hammer Kit**

Includes 5 chisels. Quick change retainer. 3,530 blows per minute. Great for exhaust, front end jobs, general bolt cutting, pin driving, and body shearing work. Sale \$229.38 **Tool Club \$183.50**



TA94400 Retainer

Fits IR117 & all CP except #716. Sale \$28.13 **Tool Club \$22.50**



TA94450 Retainer

Fits IR121 & CP716. Sale \$28.13 **Tool Club \$22.50**



## AIR HAMMER ACCESSORIES



LIS41440

**5pc Stepped Pickle Fork Kit**

Sizes: 11/16"-1-5/8". Forks can be used with an dle or air hammer. Sale \$124.94 **Tool Club \$99.95**



MAY37323

**3pc Long Pneumatic Tool Set**

Black oxide finish. Extra long body for hard-to-reach areas. Includes long scraper, long taper punch, and sharp point long taper punch. Sale \$107.19 **Tool Club \$85.75**



STK71415

**Axle Popper II**

The air tool version of the popular Axle Popper, breaks loose half shafts from transaxle on front wheel drive vehicles. Tapered on both ends of the wedge along with a 6" shaft to fit an air hammer. Safer than using a pry bar! Sale \$74.94 **Tool Club \$59.95**



MAY31940

**5pc Pneumatic Separating Fork Set**

Handles ball joints with minimal shock to the assembly. .401 shank. 11/16", 15/16", 1-11/16", 1-3/8", 1-1/8". Sale \$178.69 **Tool Club \$142.95**

MAY37315

**3/8" Shake n Break**

Sale \$19.94 **Tool Club \$15.95**



MAY37316

**1/2" Shake n Break**

Sale \$24.94 **Tool Club \$19.95**



SY11600

**Extra Long 3pc Air Hammer Drift Punch Set**

3 most common sizes: 5/16"/8mm, 3/8"/10mm & 1/2"/12mm. 5" long parallel pin driver. 3pc Storage Bag. Sale \$69.94 **Tool Club \$55.95**



LIS41400

**Stepped Pickle Fork Kit**

Design helps keep tool from bouncing back. Sale \$70.63 **Tool Club \$56.50**



LIS62140

**Seized Fastener Remover Kit**

Sale \$112.44 **Tool Club \$89.95**



MAY32025

**4pc Pneumatic Hammer Set**

Sizes: 1" x 8", 1" x 1-1/4", 1" x 6" & 1" x 12". Standard .401 turn type. Shanks for air guns. Sale \$117.44 **Tool Club \$93.95**



.498

GYCS807

**7pc H.D. Chisel Set**

Set Includes: 5/8" flat chisel, tapered punch, straight punch, dual blade panel cutter, rivet cutter, 1-1/4" diameter hammer, & bushing splitter. Sale \$104.94 **Tool Club \$83.95**



CTA1000

**VibroShock Impact Tool Kit**

7 Metric Impact Sockets - 8, 9, 10, 11, 12, 13, 14mm. All 3/8" square drive & all with "Internal Edge" Sale \$106.19 **Tool Club \$84.95**



LIS29450

**Short Anchor Pin Bushing Driver**

7" Drive for limited access. Removes & installs truck & trailer 1-3/8" anchor pin bushings and stuck anchor pins. Also removes truck leaf spring bushings. Sale \$62.44 **Tool Club \$49.95**





**IRW5133-K22**  
**3/8" Drive IQv20 Mini Impact Wrench w/ (2) Batteries**  
 • Includes (1) 2.5aH & (1) 5aH battery  
 • Nut Busting Torque: 550 ft/lbs  
 • Max Torque: 365 ft/lbs  
 Sale \$712.44 **Tool Club \$569.95**

**IRW5133**  
**3/8" Drive 20V Brushless Impactool - BARE TOOL ONLY**  
 Sale \$374.94 **Tool Club \$299.95**



**IRW7152-K22**  
**1/2" IQv20 Impact Wrench Kit with (2) Batteries, Charger and Tool Bag**  
 • Includes (2) 20V 5.0 aH batteries  
 • Nut-Busting Torque: 1,500 ft/lbs  
 • Weight: 7.6 lbs  
 Sale \$749.94 **Tool Club \$599.95**

**IRW7152**  
**1/2" Drive IQv20 Brushless Impactool - BARE TOOL ONLY**  
 Sale \$462.44 **Tool Club \$369.95**



**IRW7172-K22**  
**3/4" Dr. 20V Brushless High Impact Wrench w/ (2) Batteries Kit**  
 • Nut Busting Torque: 1,500 ft/lbs  
 • Max Torque: 1,000 ft/lbs  
 Sale \$812.44 **Tool Club \$649.95**

**IRW7172**  
**3/4" Drive 20V Brushless Impactool - BARE TOOL ONLY**  
 Sale \$499.94 **Tool Club \$399.95**

**IRW9691-K4E**  
**1" Extended Anvil IQv20 Impact Wrench Kit**  
 • 3,000 ft/lbs of nut busting torque  
 • Brushless motor  
 • Two (2) batteries operate the gun at the same time!  
 • Three (3) torque settings  
 • 360° adjustable D-Handle.  
 • Includes 1 Dual Bay Charger & (4) BL2022 batteries  
 Sale \$1,999.94 **Tool Club \$1,599.95**

**IRW9691**  
**1" Extended Anvil IQv20 Impact Wrench - TOOL ONLY**  
 Sale \$1,374.94 **Tool Club \$1,099.95**



**3/4" CORDLESS**

**MLW2864-22**  
**M18 FUEL™ 3/4" High Torque Impact Wrench with ONE-KEY™ Kit**  
 Includes Tool, (2) XC5.0 Extended Capacity Batteries, M18 & M12 Multi-Voltage Charger & Carrying Case  
 Sale \$835.63 **Tool Club \$668.50**



**MLW2864-20**  
**M18 FUEL™ 3/4" High Torque Impact Wrench with ONE-KEY™ TOOL ONLY**  
 Up to 1,500ft-lbs Nut-Busting Torque. 1,200ft-lbs of fastening torque.  
 Sale \$456.88 **Tool Club \$365.50**



**1" CORDLESS**

**MLW2867-22**  
**M18 FUEL™ 1" High Torque Impact Wrench with ONE-KEY™ Kit**  
 Includes tool, (2) CX8.0 Batteries, M18 & M12 Rapid Charger & Contractor Bag  
 Sale \$1,449.94 **Tool Club \$1,159.95**



**MLW2867-20**  
**M18 FUEL™ 1" High Torque Impact Wrench with ONE-KEY™ — TOOL ONLY**  
 1,800 ft-lbs Nut-Busting Torque. 1,500 ft-lbs of fastening torque.  
 Sale \$999.94 **Tool Club \$799.95**



**1" CORDLESS**

**MLW2868-22HD**  
**M18 FUEL™ 1" D-Handle High Torque Impact Wrench Kit**  
 2,000 ft-lbs nut-busting torque. 1,900 ft-lbs of fastening torque. Up to 200 bolts per charge. Includes tool, High Output HD12.0 battery pack and M18™ & M12™ Rapid Charger.  
 Sale \$1,812.44 **Tool Club \$1,449.95**



**MLW2869-22HD**  
**M18 FUEL™ 1" D-Handle Ext. Anvil High Torque Impact Wrench Kit**  
 2,000 ft-lbs nut busting torque. 1,900 ft-lbs of fastening torque. Lug-Nut mode prevents over-torque. Includes tool, (2) High Output HD12.0 Battery packs, M18 & M12 Rapid Charger, Tool-Free Adjustable Handle, Lanyard Loop & Carrying Case  
 Sale \$1,837.44 **Tool Club \$1,469.95**



# DRILLS



**MLW2803-22**  
**M18 FUEL 1/2" Drill Driver Kit**  
 1,200 in-lbs of torque & 2,000 RPM. The REDLINK PLUS™ intelligence ensures maximum performance and protects from overloads, heating or over-discharge. Sale \$453.13 **Tool Club \$362.50**

**MLW2803-20**  
**M18 FUEL™ 1/2" Drill Driver - TOOL ONLY**  
 Sale \$216.88 **Tool Club \$173.50**

**MLW2853-22CT**  
**M18 FUEL™ Hex Impact Driver Kit**  
 2,000 in-lbs of Max Torque. 3,600 RPM. 4-Mode Drive Control. Includes tool, (2) M18 REDLITHIUM CP2.0 batteries, (1) M18 & M12 Multi-Voltage Charger, Bit Holder & Carrying Case. Sale \$362.44 **Tool Club \$289.95**

**MLW2853-20**  
**M18 FUEL™ 1/4" Hex Impact Driver - TOOL ONLY**  
 Sale \$219.38 **Tool Club \$175.50**

**MLW2596-22**  
**M12 FUEL 2pc Kit - 1/2" Drill & 1/4" Hex Impact**  
 1/2" Drill: 1,700 RPM & 350in.-lbs. of torque. 1/4" Hex Impact: 3,300 PRM w/ 4-Mode Drive Control. Sale \$359.94 **Tool Club \$287.95**

**MLW2475-21XC**  
**M12™ Compact Inflator Kit**  
 Fastest Cordless Tire Inflator. 120 max PSI. 26" hose. Includes Inflator, Battery Pack & Battery Charger. Sale \$225.63 **Tool Club \$180.50**

**MLW2475-20**  
**M12™ Compact Inflator - TOOL ONLY**  
 Sale \$145.63 **Tool Club \$116.50**

**MLW2848-20**  
**M18 Tire Inflator**  
 Top off 33" light truck tires in under 1 minute. Rated for 150 PSI max. PSI Memory Preset. Truefill™ Technology. On-Board hose & Nozzle Storage. Anti-Vibration Feet. Sale \$218.13 **Tool Club \$174.50**

Part #	Model	Amps	Sale	Club
MLW48-11-2412	M12	3.0	\$187.44	<b>\$149.95</b>
MLW48-11-2460	M12	6.0	\$171.19	<b>\$136.95</b>
MLW48-11-1820P	M18	2.0	\$124.94	<b>\$99.95</b>
MLW48-11-1850	M18	5.0	\$218.69	<b>\$174.95</b>
MLW48-11-1880	M18	8.0	\$293.69	<b>\$234.95</b>

**MLW2688-21**  
**M18™ Compact Heat Gun Kit**  
 Reach operational temperature in 7 seconds. Guarded nozzle. 6.4" long. Built in ladder hook & LED light. Includes tool, (1) M18 REDLITHIUM™ XC 5.0 Extended Capacity Battery, (1) M12™ and M18™ Multi-Voltage charger, (1) 3/8" concentrator nozzle and (1) hook nozzle. Sale \$374.94 **Tool Club \$299.95**

**MLW2688-20**  
**M18™ Compact Heat Gun TOOL ONLY**  
 Sale \$173.69 **Tool Club \$138.95**

**MLW2438-22X**  
**M12 Variable Speed Polisher / Sander w/ 5pc Accessory Kit**  
 Polishing Mode: 0 - 2800 RPM. Sanding Mode: 0 - 300 RPM. Variable speed trigger. Includes 12v battery, extended battery, charger, pads, & carrying case. Sale \$281.88 **Tool Club \$225.50**

**MLW2660-21CT**  
**M18 FUEL™ 1/4" Blind Rivet Tool with ONE-KEY™ Kit**  
 4,500 lbs of pulling force. Pulls up to 9/32" stainless steel rivets. Can use Aluminum, Steel, and Stainless Steel. Includes tool, 1 M18™ CP2.0 Battery, Charger and Contractor Bag. Sale \$999.94 **Tool Club \$799.95**

**MLW2550-22**  
**M12™ Rivet Tool Kit**  
 2,000 lbs pulls force. Pulls up to 3/16" stainless steel rivets. Can use Aluminum, Steel and Stainless Steel. Range: 3/32", 1/8", 5/32, 3/16" rivets. 0.8" Stroke. Up to 2X faster than hand and pneumatic tools. Includes tool, (2) M12 REDLITHIUM™ CP1.5 battery packs, (1) charger and (1) contractor bag. Sale \$487.49 **Tool Club \$389.99**



**MLW2522-21XC**  
**M12 FUEL 3" Compact Cut Off Tool Kit**  
 20,000 RPM. Optimized for one-handed use. Bi-directional blade rotation. Includes a tool free guard and shoe that includes a vacuum adapter for dust mitigation as well as cut depth adjustment. Sale \$265.94 **Tool Club \$212.75**

**MLW2522-20**  
**M12 FUEL™ 3" Compact Cut Off Tool - TOOL ONLY**  
 Sale \$189.38 **Tool Club \$151.50**

**MLW2488-21**  
**M12™ Soldering Iron Kit**  
 Includes M12™ tool, 1 chisel tip, 1 pointed tip, 1 M12™ REDLITHIUM compact battery pack, 1 M12™ charger and carrying case. 18 second heat up time. Tool-free tip changing. Red LED indicates tool is off and still hot. Sale \$203.13 **Tool Club \$162.50**

**MLW2485-22**  
**M12 FUEL™ 1/4" Right Angle Die Grinder Kit**  
 0.3 HP Motor Output. 4-Mode speed control. 20% more power than pneumatic. M12 RED LITHIUM Battery Technology. Includes 2 batteries. Sale \$371.88 **Tool Club \$297.50**

**MLW2485-20**  
**M12 FUEL™ 1/4" Right Angle Die Grinder - TOOL ONLY**  
 Sale \$249.94 **Tool Club \$199.95**

**MLW2486-22**  
**M12 FUEL™ 1/4" Straight Die Grinder Kit**  
 0.3 HP Motor Output. 3-Mode Speed Control. 20% more power than pneumatic. Includes Tool, (2) M12 REDLITHIUM CP2.0 Batteries, (1) M12 Li-Ion Battery Charger, Carrying Case & wrenches. Sale \$371.88 **Tool Club \$297.50**

**MLW2486-20**  
**M12 FUEL™ 1/4" Straight Die Grinder - TOOL ONLY**  
 Sale \$251.88 **Tool Club \$201.50**

CORDLESS TOOLS

## STUBBY IMPACT

**MLW2555-22**  
**M12 FUEL™ Stubby**  
**1/2" Impact Wrench Kit**  
 250 ft-lbs nut busting torque. Only 4.9" long. 4-mode drive control. 2,700 RPM. Includes (1) M12 4.0Ah battery, (1) M12 2.0Ah battery, (1) M12 charger & carry case.



**MLW2555-20**  
**M12 FUEL™ Stubby 1/2"**  
**Impact Wrench - TOOL ONLY**  
 250 ft-lbs nut busting torque. 4.9" long. 4-mode drive control. 2,700 RPM.



**MLW2554-22**  
**M12 FUEL™ 3/8" Stubby**  
**Impact Wrench Kit**  
 250 ft-lbs of nut-busting torque. POWERSTATE™ Brushless Motor. 4.8" long. 4-mode drive control. Includes tool, (1) M12™ REDLITHIUM™ CP2.0 battery, (1) M12™ REDLITHIUM™ XC 4.0 Extended Capacity battery pack, (1) M12™ Lithium-ion battery charger, (1) belt clip and (1) carrying case.



**MLW2554-20**  
**M12 FUEL™ 3/8" Stubby**  
**Impact Wrench - TOOL ONLY**  
 250 ft-lbs of nut-busting torque. POWERSTATE™ Brushless Motor. 4.8" long. 4-mode drive control.



**MLW2855-22**  
**M18 FUEL™ 1/2"**  
**Compact Impact Wrench Kit**  
 250 ft-lbs Nut-Busting Torque. 4.9" Long. Auto Shut-Off™ control prevents over-tightening. Bolt removal mode offers more control after bolt breakaway. Includes tool, (2) M18™ REDLITHIUM™ XC5.0 Batteries, (1) M18 & M12 Multi-Voltage Charger & Carrying Case.

## 1/2" CORDLESS



**MLW2988-22**  
**M18 FUEL 3/8" & 1/2" 2pc Combo Kit**  
 1/2" High Torque - 1,400 ft-lbs nut busting torque. 3/8" Mid-Torque - 600 ft-lbs nut busting torque. Includes (2) 5.0Ah Batteries, Charger, & Tool Bag.



**MLW2767-22**  
**M18 FUEL 1/2" High Torque Impact**  
**Wrench w/ Friction Ring Kit**  
 1,400 ft-lbs of nut-busting torque. 1,000 ft-lbs of fastening torque. LED light to illuminate the work area. Includes impact tool, two(2) batteries, M18 & M12 Multi-Voltage charger & carrying case.

**MLW2767-20**  
**M18 FUEL 1/2" High Torque Impact**  
**Wrench w/ Friction Ring - TOOL ONLY**  
 Sale \$356.56 **Tool Club \$285.25**



**MLW2565-22**  
**M12 FUEL™ 1/2" Right**  
**Angle Impact Wrench Kit**  
 Sale \$449.94 **Tool Club \$359.95**

**MLW2564-22**  
**M12 FUEL™ 3/8" Right**  
**Angle Impact Wrench Kit**  
 220 ft-lbs of nut-busting torque. 14.1" long. 2.2" Head. Bolt removal mode offers more control after bolt breakaway. Includes tool, (2) M12™ REDLITHIUM™ CP 2.0 batteries, (1) M12™ Lithium-ion Battery Charger and (1) Contractor Bag

Sale \$449.94 **Tool Club \$359.95**

## RATCHETS



**MLW2566-22**  
**M12 FUEL 1/4" High Speed Ratchet Kit**  
 Up to 35 ft-lbs of max torque! Includes 2 12v battery, charger, & carry case.



**MLW2567-22**  
**M12 FUEL 3/8" High Speed Ratchet Kit**  
 Up to 35 ft/lbs of max torque! Includes 1 12v battery, charger, & carry case.



**MLW2559-21**  
**M12 FUEL 1/4" Extended**  
**Reach Ratchet Kit**  
 250RPM. 40 ft-lbs of torque. 14.4" Long.



**MLW2560-21**  
**M12 FUEL 3/8" Extended**  
**Reach Ratchet Kit**  
 55 ft-lbs of torque. 14.4" Long.

## NEW FROM MILWAUKEE



**MLW2771-20**  
**M18™ Transfer Pump**  
 Self-priming, connect and go. Head Height: up to 75ft. Outlet connection: 3/4" brass. Inlet connection: 3/4" brass. Pumps up to 480 GPH Lift up to 18ft. Compatible with all M18™ Battery Packs! Weighs only 8lbs!

**MLW0910-20**  
**M18 FUEL™ 6 Gallon**  
**Wet/Dry Vacuum**  
 Powerstate™ brushless motor & optimized components outperforms 3.5 peak HP vacuums. Includes: vacuum motor head, vacuum tank, vacuum cart, vacuum filter, (1) 1-7/8" x 9' flexible hose, (1) 1-7/8" crevice tool, (1) 1-7/8" utility nozzle, & (2) 1-7/8" extension wands. 87 CFM & 60" of suction.



**MLW2460-21**  
**M12™ Rotary**  
**Tool Kit**  
 Powerful 12V motor. Delivers 5,000 - 32,000RPM. Variable-Speed dial. Delivers up to 10X the tool life with grinder-style exhaust ports & front bearing protection. 1/8" Collet: Accommodates all 1/32" - 1/8" shank accessories. Compact, Lightweight design.





**MAY13095**  
17-3/4" 6pc  
**ProGrip Long Pick Set**  
Includes Straight Pro, 90° Bend Pro, Compound Bend ProGrip x 14-3/4", Hook Pro, Offset Pro, & Dual Angle ProGrip x 14-3/4"  
Sale \$118.13 **Tool Club \$94.50**

**MAY60003**  
4pc MINI  
**Hook & Pick Set**  
6-1/2" long.  
Sale \$22.81  
**Tool Club \$18.25**

**MAY13094**  
4pc ProGrip  
**Hook & Pick Set**  
Includes Straight Pick, Hook ProGrip, Dual Angle ProGrip, 90° Bend ProGrip  
Sale \$73.69  
**Tool Club \$58.95**

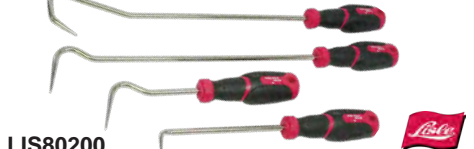

**LIS80200**  
4pc Hose Remover Set  
Long & short, standard & offset hooks. 13" Long pullers.  
Sale \$39.38  
**Tool Club \$31.50**

**CLHP4A**  
4pc Mini  
**Hook & Pick Set**  
Includes: straight, 90° & 180° & complex picks. Useful on small fuses, wire plugs, and "O" rings.  
Sale \$19.94  
**Tool Club \$15.95**



**WILW942**  
6pc Hook & Pick Set  
Includes: straight, 90°, double angle, complex, combination pick and hook picks.  
Sale \$9.94  
**Tool Club \$7.95**



**WILW948**  
9pc H.D.  
**Hook & Pick Set**  
4 mini and 4 full sized picks & 1" scraper.  
Sale \$23.69  
**Tool Club \$18.95**

**ULLCHP4-LT**  
4pc LED Hook & Pick Set  
Includes: 90 degree, hook, straight, & complex picks. Measure 9-3/4" long with LED light.  
Sale \$32.81  
**Tool Club \$26.25**

**CTA9910**  
4pc Hook & Pick Set  
All are 7" long.  
Sale \$13.69  
**Tool Club \$10.95**

**CTA9920**  
4pc Hook & Pick Set  
6-1/2" long.  
Sale \$8.13  
**Tool Club \$6.50**

**TIT17004**  
4pc Seal & O-Ring Remover Set  
2 contoured & 2 smooth tips. Lengths: 5-1/2" & 8-1/2"  
Sale \$19.94  
**Tool Club \$15.95**

**ULLCHP8-L**  
Long 9-3/4" 8 Piece Hook and Pick Set  
Ideal for separating wires, removing fuses, "O" rings, retrieving washers & other small loose parts.  
Sale \$24.94 **Tool Club \$19.95**

**KDT84000H**  
7pc Hook & Pick Set  
Variety of shapes to leverage or pull parts, springs & cotter pins  
Sale \$48.44 **Tool Club \$38.75**

**TITAN**  
**TIT17224**  
4pc Jumbo Pick Set  
10.5" Long w/metal shaft through handle.  
Sale \$29.38 **Tool Club \$23.50**

**TITAN**  
**TIT17612**  
12pc MINI Pick & Screwdriver Set  
Includes: 4 picks, Phillips: #00 & #000; Slotted: 3/32" & 1/8"; Torx: T5, T7, T8, & T10  
Sale \$33.75 **Tool Club \$27.00**

**LIS31800**  
Scribe  
Sale \$7.44 **Tool Club \$5.95**

**LIS31840**  
"O" Ring & Seal Pick  
Sale \$7.44 **Tool Club \$5.95**

**H.D. SCRAPERS**



**MAY14082**  
4pc Dominator  
**Straight Scraper Set**  
Sizes: 1/2", 3/4", 1" & 1-1/4"  
Steel shaft goes through the handle. Capped end handle for striking.  
Sale \$112.44 **Tool Club \$89.95**

**EZRMS400**  
4" Mini Scraper  
Scrape in the tightest spaces.  
Sale \$7.44 **Tool Club \$5.95**

**EZRMS600**  
6" Razer Scraper  
6" long handle with vinyl grip & angled head.  
Sale \$8.13 **Tool Club \$6.50**

**EZRMS1900**  
19" Monster Scraper  
Aluminum body stores 15 blades.  
Sale \$21.56 **Tool Club \$17.25**

**LIS52000**  
X-Long  
**Inspection Scraper**  
Sale \$14.69  
**Tool Club \$11.75**

**TIT17008**  
22pc Scraper Set  
9" scraper, 11 blades, & 10 non-marring blades.  
Sale \$19.38  
**Tool Club \$15.50**



**TIT17002**  
2pc Scraper  
4" & 9" long. 15 spare blades.  
Sale \$19.94  
**Tool Club \$15.95**

**LIS52400**  
Fold-Up Scraper  
7-3/4" Long.  
Sale \$13.69  
**Tool Club \$10.95**

**TIT11030**  
Sticker Scraper  
Sale \$10.31  
**Tool Club \$8.25**

**SURE GRIP**



**SKT86006**  
**9pc Sure Grip**  
**Combination**  
**Screwdriver Set**  
 5 Flat & 5 Phillips  
 screwdrivers.  
 Sale \$143.69  
**Tool Club \$114.95**



**SKT86320**  
**6pc Sure Grip Set**  
 Sizes: P0x3", P1x4",  
 P2x4", 1/8"x3",  
 3/16"x4" & 1/4"x1/4"  
 Sale \$67.44  
**Tool Club \$53.95**



**SKT86326**  
**6pc Sure Grip Set**  
 Sizes: P1x4", P2x4",  
 P3x6", 3/16"x4",  
 1/4"x4" & 5/16"x6".  
 Sale \$87.44  
**Tool Club \$69.95**



**SKT85112**  
**2 in 1 Pocket Screwdriver**  
 Phillips & flat bit design.  
 Sale \$6.88 **Tool Club \$5.50**



**KDT80050H**  
**6pc Phillips/Slotted**  
**Dual Material Screwdriver Set**  
 Ergonomic tri-lobe dual material handle provides  
 the optimal balance of strength and efficiency.  
 Dual material handle offers a more comfortable  
 grip and higher performance. Non-Slip black oxide  
 tip for more secure fit in fastener. Oil and solvent  
 resistant handle provides a longer tool life.  
 Sale \$76.25 **Tool Club \$61.00**



**KDT80069H**  
**4pc Phillips/Slotted**  
**Dual Material Screwdriver Set**  
 Ergonomic tri-lobe dual material handle provides  
 the optimal balance of strength and efficiency.  
 Dual material handle offers a more comfortable  
 grip and higher performance. Non-Slip black oxide  
 tip for more secure fit in fastener. Oil and solvent  
 resistant handle provides a longer tool life.  
 Sale \$81.19 **Tool Club \$64.95**

**CUSHION GRIP**



**SKT86007**  
**9pc Cushion Grip**  
**Screwdriver Set**  
 5 Flat & 5 Phillips  
 screwdrivers.  
 Sale \$143.69  
**Tool Club \$114.95**



**SKT86330**  
**6pc Cushion Grip**  
 Sizes: P0x3", P1x4",  
 P2x4", 1/8"x3",  
 3/16"x4", & 1/4"x4".  
 Sale \$73.13  
**Tool Club \$58.50**



**SKT86336**  
**6pc Cushion Grip Set**  
 Sizes: P1x4", P2x4",  
 P3x6", 3/16"x4",  
 1/4"x4" & 5/16"x6".  
 Sale \$87.44  
**Tool Club \$69.95**



**KDT80066H**  
**20pc Phillips/Slotted/Torx**  
**Dual Material Screwdriver Set**  
 Ergonomic tri-lobe dual material handle provides  
 the optimal balance of strength and efficiency.  
 Dual material handle offers a more comfortable  
 grip and higher performance. Non-Slip black oxide  
 tip for more secure fit in fastener. Oil and solvent  
 resistant handle provides a longer tool life.  
 Sale \$131.19 **Tool Club \$104.95**



**KDT80051H**  
**12pc Phillips/Slotted Dual**  
**Material Screwdriver Set**  
 Ergonomic tri-lobe dual material handle provides  
 the optimal balance of strength and efficiency.  
 Dual material handle offers a more comfortable  
 grip and higher performance. Non-Slip black oxide  
 tip for more secure fit in fastener. Oil and solvent  
 resistant handle provides a longer tool life.  
 Sale \$112.44 **Tool Club \$89.95**

**NEW!**



**VES22005EVA**  
**5pc Ball Grip Screwdriver Set**  
 Installed with a ratchet with 36 teeth gear to  
 realize comfortable operation with fine turning.  
 Cr-V Alloy Steel Shank specially hardened.  
 Made in Japan.  
 Sale \$112.44 **Tool Club \$89.95**

**NEW!**



**VES3308EVA**  
**8pc Wood-Compo Non-Slip**  
**Tang-Thru Screwdriver Set**  
 Extraordinary Non-Slip grip. Secure working  
 efficiency. 70% wood composite resin,  
 reproducing the natural material texture.  
 Cr-V alloy steel shank specially hardened.  
 Made in Japan.  
 Sale \$107.19 **Tool Club \$85.75**

**NEW!**



**VES980MIXEVA**  
**8pc MEGADORA Jawsfit Screwdriver Set - Mix**  
 NEW Phillips JAWSFIT tip that firmly grips  
 screws to reduce Cam-Out. Useful knurled  
 blade for quick and slipless turning. Cr-V Alloy  
 Steel Shank specially hardened. Made in Japan.  
 Sale \$111.88 **Tool Club \$89.50**

**NEW!**

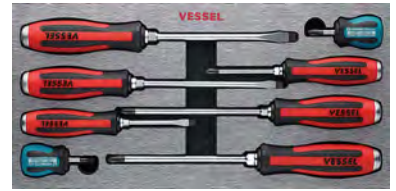

**VES9308EVA**  
**8pc MEGADORA Jawsfit Screwdriver Set - Red**  
 NEW Phillips JAWSFIT tip that firmly grips  
 screws to reduce Cam-Out. Useful knurled  
 blade for quick and slipless turning. Cr-V Alloy  
 Steel Shank specially hardened. Made in Japan.  
 Sale \$124.94 **Tool Club \$99.95**

**NEW!**



**VES9008EVA**  
**8pc MEGADORA Jawsfit Screwdriver Set - Blue**  
 NEW Phillips JAWSFIT tip that firmly grips  
 screws to reduce Cam-Out. Useful knurled  
 blade for quick and slipless turning. Cr-V alloy  
 steel shank specially hardened. Made in Japan.  
 Sale \$97.43 **Tool Club \$77.95**

**SCREWDRIVERS**

**NEW!**



**VESSEL®**

**NEW!**



**VES220USBS1U**  
**Ball Grip Cordless Rechargeable Screwdriver**  
 Forward/Reverse Switch. LED Illuminates work area.  
 17.71 lb/in torque (electric) 88.51 lb/in (manual).  
 3.6V Lithium-Ion battery.  
 Sale \$71.19 **Tool Club \$56.95**

**VES220USBS1U**  
**Ball Grip Cordless Rechargeable High Speed Screwdriver**  
 Forward/Reverse switch. LED Illuminates work area.  
 1200 RPM (MAX/no-load). 3.5 lb/in torque (electric)  
 88.5 lb/in (manual). 3.6V Lithium-Ion battery  
 Sale \$79.94 **Tool Club \$63.95**

**BIT SETS**

**KDT83518**  
**33pc Ratcheting T-Handle Hex Key Set**  
 Keys made with alloy steel. Chamfered edges on both ends. Ratcheting handle. Dual Material Grip.  
 Sale \$49.94  
**Tool Club \$39.95**



**SVT63008**  
**102PC Screwdriver And Security Bit Set**  
 Includes specialty bits such as Allen, Torx, Phillips, Slotted, Security Bits, & Bit Adapter.  
 Sale \$36.19  
**Tool Club \$28.95**



**wiha** **NEW!**

**WILW8659**  
**32pc Security Bit Set**  
 3" bits fit most power drills, screw guns & magnetic drivers. Includes tri-wing bits, torque bits, spanner bits & hex bits.  
 Sale \$16.88 **Tool Club \$13.50**



**Performance Tool** **NEW!**

**WILW9041**  
**117pc Compact Micro Bit Repair & Maintenance Set**  
 2 sided flip case with crystal clear lids.  
 Sale \$26.19 **Tool Club \$20.95**



**NEW!**

**SUN9726**  
**38 pc Mini Ratchet & Bit Set**  
 Includes 36 different screwdriver bits, a quick release extension, & micro 3-1/2" long ratchet. Will fit in the tightest of spaces.  
 Sale \$45.63 **Tool Club \$36.50**



**SUNEX TOOLS**

**EZRMS14**  
**1/4" Mini Master Set**  
 1/4" flex head drive with bit holder end. 10 bits, 3" extension, 8 spline metric sockets (4mm - 11mm).  
 Sale \$33.69 **Tool Club \$26.95**



**EZRED**

**IMPACT DRIVERS**

**LIS29200**  
**3/8" Hand Impact Tool Set**  
 Can be used with 3/8" drive impact sockets.  
 Sale \$49.94  
**Tool Club \$39.95**



**LIS30200**  
**1/2" Hand Impact Tool Set**  
 Can be used with 1/2" drive impact sockets.  
 Sale \$49.94  
**Tool Club \$39.95**



**FORD SPARK PLUG**

**LIS65700**  
**3V Ford Broken Plug Remover**  
 Unique porcelain remover tool, porcelain pusher and a self-tapping puller.  
 Sale \$137.44 **Tool Club \$109.95**



**LIS65600**  
**Broken Spark Plug Remover**  
 For 2004+ Ford Triton with 3 valves per cylinder.  
 Sale \$108.69 **Tool Club \$86.95**



**CAL39300**  
**Three Valve Ford Triton Insert Kit**  
 Designed to aid in the repair of, 3-valve 5.4 L and 6.8 L engines built before 10/9/07 and 3-valve 4.6 L engines built before 11/30/07 for many 2004-2008 Ford, Lincoln and Mercury.  
 Sale \$287.44 **Tool Club \$229.95**



**CAL38900**  
**Triton Spark Plug Thread Repair Kit**  
 Works with Ford Triton Motors (96' to 03'). Aids in repairing Ford Modular Cylinders Heads.  
 Sale \$374.94 **Tool Club \$299.95**

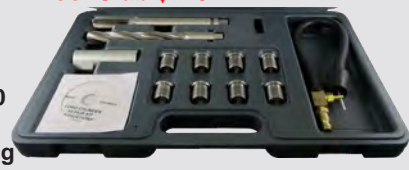

**TITAN**

**TIT16251**  
**50pc Torsion Impact Bit Set**  
 Impact grade. Includes Phillips, square drive, hex, torx, ball hex, slotted, adapters, extensions, chucks, & socket drivers.  
 Sale \$74.38 **Tool Club \$59.50**



**TITAN**

**TIT16148**  
**148pc Master Screwdriver Bit Set**  
 Wide range of screwdriver bits including many hard to find security bits.  
 Sale \$62.44 **Tool Club \$49.95**



**SUNEX TOOLS**

**SUN9729**  
**208pc Master Bit Set**  
 Includes standard & deep bits. Screwdriver bits, nut drivers, security bits, torx, tamperproof torx, hex, triple square, bit holder, and many more!  
 S2 steel construction extends bit life.  
 Sale \$86.56 **Tool Club \$69.25**



**TITAN**

**TIT16093**  
**33pc Multi-Bit Precision Screwdriver Set**  
 Extendable Screwdriver 8" Flexible Extension Shaft Magnifying Glass PH000, PH00, PH0, PH1 SL1.0, SL1.5, SL2.0, SL2.5, SL3.0, SL3.5, SL4.0 PZ0, PZ1 T4, T5, T6, T7, T8, T9, T10, T15, T20 0.7, 0.9, 1.3, 1.5, 2.0, 2.5, 3.0, 4.0  
 Sale \$18.69 **Tool Club \$14.95**



**Allows sockets to attach to a drill.**

**TIT12039**  
**Quick Change Impact Adapter**  
 Sale \$16.19  
**Tool Club \$12.95**



**TITAN**

**VIMIMPACT8**  
**8pc S2 Bit Set**  
 Fits all impact drivers.  
 Sale \$14.94 **Tool Club \$11.95**





**MAGNETS**

**TIT11064**  
**3 in 1 Flexible Retriever**  
 Retriever claw, LED light, and 3lb magnet.  
 Sale \$19.19  
**Tool Club \$15.35**



**WILW83198**  
**28" Long Flex Magnetic Claw Retriever**  
 Sale \$13.13 **Tool Club \$10.50**



**LIS31140**  
**23" Long Flexible Retrieving Tool**  
 Sale \$12.44  
**Tool Club \$9.95**

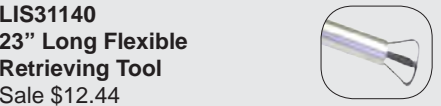

**TIT21264**  
**5-7/8" Magnetic Tray**  
 Sale \$8.13  
**Tool Club \$6.50**



**WILW1264**  
**6" Magnetic Tray**  
 Sale \$7.94  
**Tool Club \$6.35**



**TIT21265**  
**Magnetic Tray**  
 5-3/8" x 9-3/8".  
 Even works upside down.  
 Sale \$13.13  
**Tool Club \$10.50**



**WILW1265**  
**10" Magnetic Tray**  
 Sale \$15.00  
**Tool Club \$12.00**

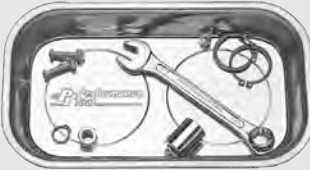

**TIT21262**  
**Square Magnetic Parts Tray**  
 10.5" x 11-1/2".  
 1" deep.  
 Rubber covered magnetic base.  
 Sale \$23.44  
**Tool Club \$18.75**



**TIT11180**  
**10.5" Magnetic Strainer**  
 11" diameter. 4" deep.  
 Great for washing dirty tools.  
 Sale \$16.56  
**Tool Club \$13.25**



**EZRTRAY-CLR**  
**3pc Collapsible Magnetic Parts Trays**  
 Expanded 2" deep, 4.25" Wide  
 Sale \$26.88  
**Tool Club \$21.50**



**EZRTRAY-QGR**  
**Expandable Magnetic Quad Tray - Green**  
 Sale \$36.19  
**Tool Club \$28.95**



**ULLHTLP-1**  
**LED Lighted Pick-Up Tool**  
 Lifts up to 8 lbs. Extends from 6.75" - 27.75".  
 Sale \$23.69 **Tool Club \$18.95**



**ULLHTLP-2**  
**LED Lighted Pick-Up Tool**  
 Lifts up to 8 lbs. Extends from 8" - 32.75".  
 Sale \$23.13 **Tool Club \$18.50**



**WILW1927**  
**Swivel LED Magnetic Pick-Up Tool**  
 Extends to 28.5". Lifts up to 8 lbs. LED light.  
 Sale \$11.88 **Tool Club \$9.50**



**ULLHT-2FL**  
**5 lb Magnetic Pick-Up Tool**  
 29" long shaft can be bent & hold any angle.  
 Sale \$18.69 **Tool Club \$14.95**



**LIS31000**  
**Telescoping Magnet**  
 Extends from 14" to 23". Lifts 2-1/2 lbs.  
 Sale \$18.13 **Tool Club \$14.50**



**WILW9101**  
**Magnetic Pickup**  
 Extends to 24". Lifts up to 8 pounds.  
 Removable rubber cap.  
 Sale \$5.63 **Tool Club \$4.50**



**WILW9102**  
**Lighted Magnet**  
 Bright LED light on the tip.  
 Extends from 7-1/2" to 32". Soft Handle.  
 Sale \$9.94 **Tool Club \$7.95**



**ULLMAN**

**HI-TECH MAGNETIC PICK-UP TOOLS WITH POWERCAP®**

**ULLHT-1**  
**2.5lb. Capacity**  
 Telescopes from 6-5/8" to 33-1/4".  
 Sale \$13.13 **Tool Club \$10.50**

**ULLHT-2**  
**5lb. Capacity**  
 Telescopes from 7-1/2" to 33-3/4".  
 Sale \$15.63 **Tool Club \$12.50**

**ULLHT-3**  
**10lb. Capacity**  
 Telescopes from 8-1/4" to 30-1/4".  
 Sale \$23.13 **Tool Club \$18.50**



**EZRED**

**EZRMM38**  
**1" Super "Monster" Magnet**  
 Telescopes to 38". Insulated handle  
 Lifting capacity 20 lbs. Can be used  
 to start bolts in tight spaces.  
 Sale \$41.88 **Tool Club \$33.50**



**MIRRORS**

**LIS32050**  
**2-1/4" Telescoping Mirror**  
 Extends from 10" to 14".  
 Sale \$12.44 **Tool Club \$9.95**



**ULLK-2**  
**Rectangular Telescoping Mirror**  
 2-1/8" x 3-1/2" mirror.  
 Extends from 11-1/4" - 15-1/4".  
 Sale \$14.94 **Tool Club \$11.95**



**ULLHTE-2**  
**1-1/4" Telescoping Inspection Mirror**  
 Telescopes from 6-1/2" to 35".  
 Sale \$14.06 **Tool Club \$11.25**



**ULLHTC-2**  
**2-1/4" Telescoping Inspection Mirror**  
 Telescopes from 6-1/2" to 36-3/8".  
 Sale \$14.06 **Tool Club \$11.25**



**ULLHTS-2**  
**3-1/4" Telescoping Inspection Mirror**  
 Telescopes from 6-1/2" to 29-1/2".  
 Sale \$16.56 **Tool Club \$13.25**



**ULLHTE-2LT**  
**1-3/8" LED Lighted Telescoping Inspection Mirror**  
 Telescopes from 6-1/2" to 35".  
 Sale \$19.94 **Tool Club \$15.95**



**ULLHTC-2LT**  
**2-3/8" LED Lighted Telescoping Inspection Mirror**  
 Telescopes from 6-1/2" to 36-3/8".  
 Sale \$21.88 **Tool Club \$17.50**



**ULLHTS-2LT**  
**3-3/8" LED Lighted Telescoping Inspection Mirror**  
 Telescopes from 11" to 30-1/8".  
 Sale \$21.19 **Tool Club \$16.95**



**TIT11065**  
**3pc Utility Tool Set**  
 Includes a mini magnetic tray, telescoping inspection mirror and magnetic pickup tool.  
 Sale \$14.06  
**Tool Club \$11.25**



**TIT11716**  
**16lb. Magnetic Pick-up Tool**  
 Telescopes from 7-3/4" to 30-3/4".  
 Sale \$8.44 **Tool Club \$6.75**



**IRWIN.**



**IWN2078710**  
**3pc GrooveLock Pliers Set**  
 Push button for easy size adjustment.  
 2x number of jaw positions. Sizes: 8", 10" & 12"  
 Sale \$86.56 **Tool Club \$69.25**

**GW GEARWRENCH**



**KDT82594C**  
**4pc Pitbull Auto-Bite Tongue & Groove Dual Material Pliers w/ K9 Jaws**  
 Exclusive Auto-Bite lever enables one handed jaw adjustment. Aggressive angled teeth for increased grip. Grip Zone handles for non-marring grip.  
 Sale \$107.44 **Tool Club \$85.95**



**KDT82118**  
**3pc Push Button Tongue & Groove Plier Set**  
 Push button for easy size adjustment.  
 2x number of jaw positions. Sizes: 8", 10", 12".  
 Sale \$106.19 **Tool Club \$84.95**

**COMPOUND JOINT PLIERS**



**KDT82106**  
**2pc Double-X Pliers Set**  
 Includes straight and 45° pliers. Jaws open greater distance than the handle for added reach in tight locations. Flush rivet.  
 Sale \$74.94 **Tool Club \$59.95**



**KDT82107**  
**3pc Double-X™ Hose Grip Plier Set**  
 3 sizes of hose grip pliers, all double joint.  
 Sale \$112.44 **Tool Club \$89.95**

**EXTRA LONG PLIERS**

**SUN3600V**  
**4pc 11" Long Nose Plier Set**  
 Includes: Straight, 20°, 45° & 90° pliers. All are 11" long.  
 Sale \$66.88  
**Tool Club \$53.50**



**SUNEX TOOLS**

**SUN3706V**  
**4pc 16" Needle Nose Pliers Set**  
 Includes: 45° & 90° Angle, Straight, & Curved Pliers.  
 Sale \$93.69  
**Tool Club \$74.95**



**WILW1044**  
**11" Long Nose Plier**  
 Sale \$12.44  
**Tool Club \$9.95**



**WILW1045**  
**11" Long Nose 30° Curved Plier**  
 Sale \$12.44  
**Tool Club \$9.95**



**WILW1046**  
**11" Long Nose Right Angle Plier**  
 Sale \$12.44  
**Tool Club \$9.95**



**WILW1047**  
**11" Long Nose Offset Plier**  
 Sale \$12.44  
**Tool Club \$9.95**



**WILW1048**  
**11" Hose Clamp Plier**  
 Sale \$12.44  
**Tool Club \$9.95**



**SUNEX TOOLS**

**SUN3703V**  
**3pc X-Long Hose Gripper Pliers**  
 11" Long. Sizes: 5/16", 1/2" & 3/4".  
 Sale \$59.38 **Tool Club \$47.50**



**ALUMINUM PIPE WRENCHES**

Constructed of strong and lightweight aluminum for strength and ease of use.



**Performance Tool**

Part #	Length	Sale	Club
WILW2114	14"	\$28.69	<b>\$22.95</b>
WILW2124	24"	\$58.69	<b>\$46.95</b>
WILW2148	48"	\$199.94	<b>\$159.95</b>

**ADJUSTABLE WRENCHES**

**SUN9618**  
**4pc Adjustable Wrench Set**  
 Sizes: 6", 8", 10" & 12".  
 Ergonomic no-slip rubber grip.  
 Sale \$64.94  
**Tool Club \$51.95**

**SUNEX TOOLS**



**CL8WCB8**  
**8" Large Capacity Adjustable Wrench**  
 Over 1-1/2" opening.  
 Sale \$37.44  
**Tool Club \$29.95**

**CHAN NEL LOCK**



**CL6SWCB**  
**6" Xtra Slim Adjustable Wrench**  
 Xtra slim 3/16" jaws.  
 Super wide jaw capacity (1.34").  
 Sale \$41.19  
**Tool Club \$32.95**



**IRWIN.**

**IWN2078706**  
**Vise-Grip 4pc Adjustable Wrench Set**  
 Sizes: 6", 8", 10" & 12".  
 Double chrome vanadium construction  
 Sale \$76.25  
**Tool Club \$61.00**



**TITAN SHEARS**



Cuts up to 1/4" thick. Locking mechanism.

Part #	Size	Sale	Club
TIT12441	7"	\$15.63	<b>\$12.50</b>
TIT12442	9"	\$18.13	<b>\$14.50</b>
TIT12443	10"	\$21.19	<b>\$16.95</b>
TIT12444	10" Offset	\$22.44	<b>\$17.95</b>

## ADJUSTABLE WRENCHES

# CHANNEL LOCK

RUGGED CHROME VANADIUM  
STEEL CONSTRUCTION WITH  
CHROME FINISH



Part #	Length	Jaw Capacity	Sale	Club
CL808	8"	0.75"	\$27.81	\$22. <sup>25</sup>
CL810	10"	0.94"	\$30.94	\$24. <sup>75</sup>
CL812	12"	1.13"	\$46.19	\$36. <sup>95</sup>
CL815	15"	1.31"	\$74.94	\$59. <sup>95</sup>
CL818	18"	1.63"	\$130.63	\$104. <sup>50</sup>
CL824	24"	2.25"	\$249.94	\$199. <sup>95</sup>

## LOCK RING PLIERS

For snap rings without holes, found on  
brakes, transmissions, & clutches.

**LANG**  
TOOLS  
Professional Tools For 4 Generations



**LANG1705**  
10" Parallel Jaw Lock Ring Plier  
Sale \$53.69 **Tool Club \$42.95**

**LANG**  
TOOLS  
Professional Tools For 4 Generations



**LANG1407**  
9" Straight Tip Lock Ring Plier  
Sale \$33.69 **Tool Club \$26.95**



**LIS44900**  
9" Lock Ring Plier  
Sale \$20.31 **Tool Club \$16.25**

**LANG**  
TOOLS  
MADE IN USA



**LANG3495**  
12pc Combination  
Internal & External Snap Ring Pliers  
Sizes: .038, .047, .070, & .090 in 0, 45  
and 90-degree angles.  
Sale \$129.94 **Tool Club \$103.95**

**LANG**  
TOOLS



**LANG1421**  
Quick Switch Pliers with  
Adjustable Stop and Tip Kit  
Internal Sizes: 1/4" - 1" (8 - 26mm)  
External Sizes: 1/8" - 1" (3- 26mm).  
Sale \$28.13 **Tool Club \$22.50**

**LANG**  
TOOLS

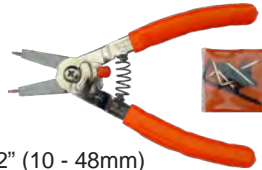

**LANG1434**  
Quick Switch  
Pliers with Tip Kit  
Internal Sizes: 3/8" - 2" (10 - 48mm)  
External: 1/4" - 2" (7 - 48mm)  
Sale \$32.19 **Tool Club \$25.75**

**LIS49200**  
Snap Ring  
Pliers



Works on internal and external  
snap rings. Includes set of tips.  
Sale \$44.06 **Tool Club \$35.25**

**LANG**  
TOOLS  
Professional Tools For 4 Generations

MADE IN USA

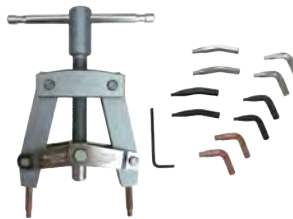

**LANG87**  
H.D. Pliers with Tip Kit  
Internal & External 3.5" - 7".  
Compound screw lever for easy installation  
and removal of extra large retaining rings.  
Sale \$110.63 **Tool Club \$88.50**

**LANG**  
TOOLS

**NEW!**

MADE IN USA



**LANG1406**  
3pc Lock Ring Pliers Set  
9" Straight Tip, 9" Bent Tip  
and 9" Right Angle Tip.  
Spreads, installs & removes lock rings that  
don't have holes. Made in the USA.  
Sale \$87.44 **Tool Club \$69.95**

**NEW!**

**AST9401**  
10pc Snap Ring  
Pliers Set  
Operates both internal  
& external rings.  
Comfortable insulated  
vinyl handles.  
Sale \$46.88  
**Tool Club \$37.50**



**WIL5212**  
300pc External  
Snap Ring  
Contains 18 various  
popular sizes.  
Sale \$10.63  
**Tool Club \$8.50**



**LANG**  
TOOLS

MADE IN USA



**LANG1465**  
3pc Quick Switch Pliers Set  
Includes LANG1421, LANG1434,  
and LANG75 - Internal /External Ring  
Pliers w/ Automatic Ratchet Lock.  
Includes 5 pairs of interchangeable tips.  
Sale \$124.94 **Tool Club \$99.95**

## XL SNAP RING PLIERS

**LANG**  
TOOLS

MADE IN USA



**LANG1485**  
Internal Retaining Ring Pliers  
Ring Sizes: 3-1/16" - 6-1/4"  
Sale \$81.88 **Tool Club \$65.50**

**LANG1486**  
External Retaining Ring Pliers  
Ring Sizes: 3-1/2" - 6-1/2"  
Sale \$81.88 **Tool Club \$65.50**

**Astro Pneumatic**



**AST9402**  
XL 16" Snap Ring Set  
One internal plier, one external plier.  
With straight, 45° and 90° tips.  
Sale \$60.63 **Tool Club \$48.50**

**NEW!**

**LANG**  
TOOLS  
Professional Tools For 4 Generations

MADE IN USA



**LANG3595**  
12pc Quick Switch Snap Ring Plier Set  
Quick switch design allows the user to change  
from internal to external configurations without  
taking the pliers apart. Cushion grip handles  
for extra support. Sizes: .038", .047", .090"  
in 0°, 45°, & 90° angles.  
Sale \$181.56 **Tool Club \$145.25**

**INSULATED TOOLS**

**TIT17237  
7pc Insulated  
Electrical  
Screwdriver Set**

Sizes included:  
(3) Phillips (3" x #0, 4" x #1 and 4" x #2) and  
(4) Slotted (3" x 1/8", 4" x 5/32", 5" x 7/32" &  
6" x 1/4"). Insulated blades for applications  
up to 1000 volt AC & 1500 volt DC.  
Magnetic drive tips.  
Sale \$28.13 **Tool Club \$22.50**



**wiha**

**WIHA32867  
10pc  
Insulated  
Tool Set**

Includes: 4 pliers, crimpers, 5 screwdrivers.  
Sale \$288.69 **Tool Club \$230.95**



**wiha**

**WIHA21093  
Insulated 16PC Deep Offset  
Metric Wrench Set**

Sizes: 8mm - 32mm. Certified to 1000V AC  
or 1500V DC. Protective double insulation  
molded directly onto the wrench. Forged  
chrome canadium steel under insulation.  
Comes with roll-up pouch.  
Sale \$824.94 **Tool Club \$659.95**



**wiha**

**WIHA21094  
Insulated 16PC Deep  
Offset SAE Wrench Set**

Sizes: 8mm - 32mm. Certified to 1000V AC  
or 1500V DC. Protective double insulation  
molded directly onto the wrench. Forged  
chrome canadium steel under insulation.  
Comes with roll-up pouch.  
Sale \$724.94 **Tool Club \$579.95**



**wiha**

**WIHA32800**

**Insulated 80PC Set In Rolling Tool Case**  
Insulated 10,000V tested and 1,000V rated.  
Set includes: Pliers, Adjustable Wrench,  
Slotted Screwdrivers, Phillips Screwdrivers,  
SAE Nut Drivers, Metric Nut Drivers,  
Hex SAE T-Handles, Hex Metric T-Handles,  
Torx Screwdrivers, Square Screwdrivers  
Sale \$2,337.44 **Tool Club \$1,869.95**



**CHAN NEL LOCK**



**CLTR6LC  
6pc Little Champ Tool Roll**

Includes: slip joint, side cutting, end cutting,  
long nose, snipe nose, and tongue & groove  
pliers. Stubby sizes between 4" & 6".  
Sale \$151.19 **Tool Club \$120.95**



**EZRKWP2  
2pc Kiwi  
Plier Set**

Includes 6" short &  
8" long needle-nose  
pliers at an angle.  
Curved handles.  
Sale \$28.13  
**Tool Club \$22.50**



**IWN2078707  
4pc VISE-GRIP  
Pliers Set**

6" Diagonal Cutting,  
6" Slip Joint,  
8" Long Nose &  
10" Groove Joint.  
Sale \$68.69  
**Tool Club \$54.95**



**CHAN NEL LOCK**



**CLC8R-8  
8pc Code Blue Plier Set**

Includes 2 tongue & groove, linemen's,  
end cutter, long nose, cutting, crimping  
& cable cutter. Code Blue special grip.  
Sale \$274.94 **Tool Club \$219.95**



**CHAN NEL LOCK**



**CL431KB  
5pc Plier Set**

Includes: 2 Tongue & Groove,  
Cutting, Long Nose, & Slip Joint.  
Sale \$96.19 **Tool Club \$76.95**



**MADE IN USA TONGUE GROOVE WATER PUMP CHAN NEL LOCK**

Part #	Length	Sale	Club
CL424G	4-1/2"	\$18.69	<b>\$14.95</b>
CL426G	6-1/2"	\$16.56	<b>\$13.25</b>
CL410G	9-1/2"	\$22.81	<b>\$18.25</b>
CL420G	9-1/2"	\$19.94	<b>\$15.95</b>
CL430G	10"	\$20.63	<b>\$16.50</b>
CL440G	12"	\$24.06	<b>\$19.25</b>
CL460G	16"	\$39.19	<b>\$31.35</b>
CL480G	20"	\$74.94	<b>\$59.95</b>



**MADE IN USA SLIP JOINT W/ WIRE SHEAR**

Part #	Length	Sale	Club
CL526G	6" THIN	\$13.69	<b>\$10.95</b>



**MADE IN USA BOX JOINT CUTTING**

Part #	Length	Sale	Club
CL437G	7"	\$25.31	<b>\$20.25</b>
CL758G	7.5"	\$37.44	<b>\$29.95</b>



**MADE IN USA HIGH LEVERAGE CUTTING**

Part #	Length	Sale	Club
CL337G	7"	\$24.94	<b>\$19.95</b>
CL338G	8"	\$27.44	<b>\$21.95</b>
CL447G	7" angled head	\$34.06	<b>\$27.25</b>



**CL358G  
8" End Cutter**

Sale \$32.94 **Tool Club \$26.35**



**MADE IN USA LINESMAN ROUND NOSE**

Part #	Length	Sale	Club
CL369G	9"	\$36.56	<b>\$29.25</b>



**MADE IN USA LONG NOSE WITH CUTTER**

Part #	Length	Sale	Club
CL326G	6"	\$27.19	<b>\$21.75</b>
CL317G	7"	\$28.13	<b>\$22.50</b>
CLE318	8"	\$28.69	<b>\$22.95</b>



**CL442G  
12" V-Jaw**

Opens to 2-1/4"  
Sale \$22.81 **Tool Club \$18.25**



**KDT82203**  
**3pc Pitbull Dipped Handle Electrician's Plier Set**  
 Professional, ergonomic grips wipe clean easily. Includes: Lineman's Pliers, Diagonal Cutting Pliers, Long Nose Pliers & Universal Pliers.  
 Sale \$101.88 **Tool Club \$81.50**



**KDT82204**  
**6pc Pitbull Dipped Handle Mixed Plier Set**  
 Professional, ergonomic grips wipe clean easily. Includes: Lineman's Pliers, Diagonal Cutting Pliers, Long Nose Pliers, Slip Joint Pliers, & (2) Tongue and Groove Pliers.  
 Sale \$149.94 **Tool Club \$119.95**



**KDT82204C** **NEW!**  
**6pc Pitbull Dual Material Mixed Plier Set**  
 Professional, ergonomic dual material grips with tether point. Includes: Lineman's Pliers, Diagonal Cutting Pliers, Long Nose Pliers, Slip Joint Pliers, (2) Tongue and Groove Pliers.  
 Sale \$156.19 **Tool Club \$124.95**

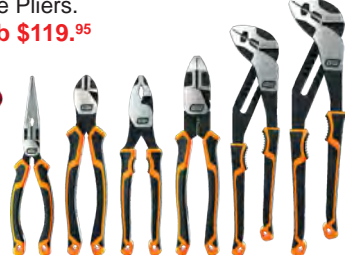

**Milwaukee** **NEW!**  
**MLW48-22-3695**  
**5pc TORQUE LOCK™ Locking Pliers Kit**  
 Faster Setup and additional locking force. Hardened jaws with better grip force. Screwdriver through-hole provides you with leverage for tightening the thumb screw. Set Includes: 5" Curved Jaw, 7" Curved Jaw, 10" MAXBITE™ curved locking pliers, 7" straight jaw locking pliers & 6" long nose locking pliers.  
 Sale \$74.94 **Tool Club \$59.95**



**MLW48-22-3690** **NEW!**  
**10pc Torque Lock™ Locking Pliers Kit**  
 Set Includes: 5" Curved Jaw, 7" Curved Jaw, 7" MAXBITE™, 10" with MAXBITE™, 7" Straight Jaw, 10" Straight Jaw, 6" Long Nose, 9" Long Nose, 6" C-Clamp & 11" C-Clamp  
 Sale \$156.19 **Tool Club \$124.95**

**SWIVEL PAD "C" CLAMPS**



These C-Clamps have **swivel pads. Good for holding sheet metal.**



Part #	Size	Sale	Club
IWN4SP	4"	\$18.44	<b>\$14.75</b>
IWN6SP	6"	\$22.81	<b>\$18.25</b>
IWN11SP	11"	\$34.06	<b>\$27.25</b>
IWN18SP	18"	\$48.44	<b>\$38.75</b>

**"C" CLAMPS**



Part #	Size	Sale	Club
IWN6R	6"	\$20.31	<b>\$16.25</b>
IWN11R	11"	\$34.06	<b>\$27.25</b>
IWN18R	18"	\$48.44	<b>\$38.75</b>
IWN24R	24"	\$57.81	<b>\$46.25</b>

**IWN18DR**  
**18" Wide Jaw Locking Pliers**  
 7.5" Jaw Capacity  
 Sale \$54.94 **Tool Club \$43.95**



**IWN9AC**  
**9" Locking Panel Clamp**  
 Bottom jaw slides forward to clamp at 90°. Sale \$30.94 **Tool Club \$24.75**



**IWN9R**  
**9" Locking Welding Clamp**  
 Sale \$31.88 **Tool Club \$25.50**



**IWN12LC**  
**12" Large Jaw Locking Pliers**  
 Heavy-duty jaws grip around work of all shapes. Sale \$30.94 **Tool Club \$24.75**



**IWN1078** **IRWIN**  
**10pc VISE-GRIP Locking Pliers Set with Tray**  
 Includes 6" and 11" Original Locking Clamps, 10" and 7" straight jaw, 10" and 7" curved jaw, 7" and 5" curved jaw with wire cutter, 6" and 9" long nose with wire cutter.  
 Sale \$178.13 **Tool Club \$142.50**

**SPECIALTY CLAMPS**



Straight jaw gives maximum contact on flat, square, or hex surfaces.

Part #	Length	Sale	Club
IWN7R	7"	\$22.19	<b>\$17.75</b>
IWN10R	10"	\$24.06	<b>\$19.25</b>



Curved jaw will grab any shape object and hold it tight.

Part #	Length	Sale	Club
IWN7CR	7"	\$21.69	<b>\$17.35</b>
IWN10CR	10"	\$24.06	<b>\$19.25</b>



Combines curved jaw plier with a wire cutter.

Part #	Length	Sale	Club
IWN4WR	4"	\$16.56	<b>\$13.25</b>
IWN5WR	5"	\$21.69	<b>\$17.35</b>
IWN7WR	7"	\$22.19	<b>\$17.75</b>
IWN10WR	10"	\$24.06	<b>\$19.25</b>

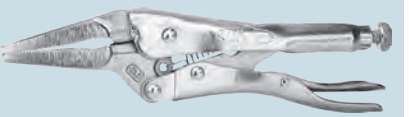

Long nose with wire cutter.

Part #	Length	Sale	Club
IWN4LN	4"	\$19.94	<b>\$15.95</b>
IWN6LN	6"	\$24.06	<b>\$19.25</b>
IWN9LN	9"	\$28.75	<b>\$23.00</b>



**IWN20R**  
**Locking Chain Clamp**  
 18" Chain  
 Sale \$38.75 **Tool Club \$31.00**



**IWNRR**  
**Locking Pinch-Off Tool**  
 Sale \$22.81 **Tool Club \$18.25**



**IWN8R**  
**8" Locking Sheet Metal Tool**  
 Makes bending, forming & crimping jobs easier & faster. Sale \$26.56 **Tool Club \$21.25**

## SPARK PLUG SOCKETS

**SKT4424**  
3/8" Drive,  
3/4" Spark Plug Socket  
Sale \$23.13  
**Tool Club \$18.50**



**SKT4426**  
3/8" Drive,  
13/16" Spark Plug Socket  
Sale \$18.69  
**Tool Club \$14.95**



**SKT4490**  
3/8" Flex Drive,  
13/16" Spark Plug Socket  
Sale \$34.38  
**Tool Club \$27.50**



**SKT4480**  
3/8" Flex Drive,  
5/8" Spark Plug Socket  
Sale \$33.13  
**Tool Club \$26.50**



**SKT4420**  
3/8" Drive Spark  
Plug Socket 5/8"  
Sale \$16.19  
**Tool Club \$12.95**



**SKT4421**  
3/8" Drive Extra Long  
Spark Plug Socket 5/8"  
Sale \$24.94  
**Tool Club \$19.95**



**SKT4419**  
9/16" Socket  
For 2004 Ford F-150 spark plugs.  
Sale \$16.19  
**Tool Club \$12.95**



**SKT4499**  
12pc 3/8" Dr. Chrome Spark Plug Socket Set  
Includes 13/16" Flex, 5/8" Flex, 9/16" Flex,  
12pt 14mm Flex, 6pt 14mm Flex, Extra Long 5/8",  
9/16", 5/8", 3/4", 13/16", 12pt 14mm & 6pt 14mm.  
Sale \$274.94 **Tool Club \$219.95**



**SKT4498**  
8pc 3/8" Drive Spark Plug Socket Set  
Includes: 9/16" (Ford), 9/16" Flex, 5/8", 5/8" Flex,  
Extra Long 5/8", 3/4", 13/16" & 13/16" Flex.  
Sale \$174.94 **Tool Club \$139.95**



**SUN8845**  
7pc 3/8" Drive  
Spark Plug  
Socket Set  
Sizes: 9/16", 5/8",  
13/16", 16mm Thin Wall &  
9/16", 5/8" & 13/16" Extra Deep.  
Sale \$89.38 **Tool Club \$71.50**



**LANG528**  
5/8" Magnetic  
Spark Plug Socket  
Sale \$14.38  
**Tool Club \$11.50**



Magnet  
holds the  
spark plug.



**LANG529**  
13/16" Magnetic  
Spark Plug Socket  
Sale \$14.38  
**Tool Club \$11.50**

**CTA2376**  
BMW Spark Plug Socket  
12pt. x 14mm  
Services '07+ 335, & 535 3.0L BMWs.  
3/8" square drive plus hex drive.  
Sale \$12.44 **Tool Club \$9.95**



**VIMSPM100**  
Spark Plug Socket Master Set  
Standard: 14mm, 9/16", 5/8" & 13/16"  
Extra Deep: 9/16" - 13/16"  
U-Joint: 14mm, 9/16" - 13/16"  
Thin Wall: 14mm & 16mm  
Sale \$124.94 **Tool Club \$99.95**



**KDT41740D**  
3pc Magnetic  
Universal 5/8" Spark Plug Set  
4", 6" & 11" long. All have magnets.  
Sale \$76.88 **Tool Club \$61.50**



**KDT80601**  
5pc Magnetic Spark Plug Set  
5/8" Sockets: 4", 6" & 11" long.  
9/16" Sockets: 2-1/2" & 6"  
Sale \$103.13 **Tool Club \$82.50**



Part #	Size	Length	Sale	Club
CTA2390	9/16"	10"	\$29.06	<b>\$23.25</b>
CTA2394	14mm	10"	\$29.06	<b>\$23.25</b>
CTA2395	5/8"	14"	\$38.69	<b>\$30.95</b>
CTA7654	14mm	8.7"	\$39.69	<b>\$31.75</b>
CTA1061	14mm	3.6"	\$28.44	<b>\$22.75</b>
SUN884504	16mm	1.54"	\$12.44	<b>\$9.95</b>
SUN884505	9/16"	6.8"	\$24.94	<b>\$19.95</b>
SUN884506	5/8"	7.4"	\$26.88	<b>\$21.50</b>

## SPARK PLUG TOOLS

**LIS19380**  
Inductive Spark Indicator  
Sale \$11.88 **Tool Club \$9.50**



**TA36350**  
In-Line  
Spark Checker



For recessed plugs, noid lights and IAC test lights kit. Test spark plug circuits, electronic fuel injection signals & idle air control circuits.  
Sale \$85.63 **Tool Club \$68.50**

**TA23970**  
4pc In-line  
Spark Tester  
Set for recessed plugs.  
Sale \$26.88  
**Tool Club \$21.50**

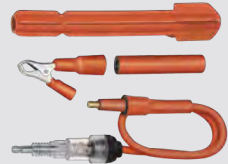

**LIS51750**  
Adjustable Spark  
Plug Boot Pliers  
Jaws can adjust  
to 5 positions.  
Sale \$36.56  
**Tool Club \$29.25**



**LIS52990**  
2 Position Spark  
Plug Boot Pliers  
Special jaws can grip from front or side.  
Sale \$12.81  
**Tool Club \$10.25**



**LIS20610**  
Dual In-line Spark Tester  
Features reversible,  
straight / 90 deg. boot.  
Sale \$19.38  
**Tool Club \$15.50**



**LIS20580**  
In-Line Spark Tester  
w/ Coil-On-Plug Wire  
Features reversible, straight / 90  
deg. boot & 7" extension plug wire.  
Sale \$35.63 **Tool Club \$28.50**



## SPARK PLUG THREAD REPAIR



**LIS65200**  
Spark Plug  
Hole Repair Kit  
Replaces stripped spark plug threads on  
aluminum heads with 14mm spark plugs.  
Sale \$144.38  
**Tool Club \$115.50**

**CTA2340**  
Spark Plug  
Cylinder Head Rethreader Kit - 14mm  
Repairs damaged threads on aluminum heads.  
Includes 3/8", 7/16" & 3/4" inserts.  
Sale \$26.56 **Tool Club \$21.25**



**TIT51950 Eco Burr™ External Deburrer**

Quickly repairs damaged threads on steel bolts. Works with most power drills on materials ranging from 5/16" to 7/8". Sale \$58.13 **Tool Club \$46.50**



**THREAD REPAIR**

**CTA3838 E-Z Chamfer®**

5 Point design for quick and clean deburring. Size: 5/16" - 7/8" Range (8-22mm) Sale \$49.94 **Tool Club \$39.95**



**CTA8240 53pc Universal Rethreading Set**

Includes thread files and color coded taps and dies for the following sizes: Metric: 6, 8, 10, 11, 12, 14mm SAE NC: 1/4", 5/16", 3/8", 7/16", 1/2", 9/16" SAE NF: 1/4", 5/16", 3/8", 7/16", 1/2", 9/16" Sale \$176.88 **Tool Club \$141.50**



**LIS70500 Tap Sockets**

Holds taps up to 1/2". Sale \$45.94 **Tool Club \$36.75**



**LIS71670 5pc Large Tap Socket Set**

Holds taps up to 1" Sale \$96.19 **Tool Club \$76.95**



**IWN3095001 2pc Tap Sockets**

Adjustable sockets holds taps up to 1/2" Sale \$40.31 **Tool Club \$32.25**



**WILW88031 H.D. Nut Splitter**

For splitting nuts 7/16" - 7/8". Use a 3/4" Wrench or socket for the adjustment bolt. Sale \$15.63 **Tool Club \$12.50**



**NES1A Universal External Thread Repair Tool**

External: 5/32 to 11/16-Inch | 4-19 mm. No calibration required Self Adjusting to any pitch & size within range. Chases good threads to repair damaged ones. Sale \$93.13 **Tool Club \$74.50**



**NES1025 Thread Restorer Kit**

Internal: 5/16" - 1-1/4". External: 5/32" - 1-1/2". Quickly adjusts to any thread diameter and pitch. Can be used on any type of thread! Sale \$612.44 **Tool Club \$489.95**



**WLT18001 Tap Extractor Set**

The hardened steel fingers of the extractors fit in the flutes of a broken tap to back it out simply and safely. 3/16" - 1/2". 4 flute design. Replacement flutes available. Sale \$168.69 **Tool Club \$134.95**



**LANG2584 15pc Metric Thread Restorer Set**

Contains 7 metric taps and dies from 6mm - 12mm & metric thread restorer file. Sale \$49.69 **Tool Club \$39.75**



**LANG2573 3pc Thread Restorer Files**

For SAE & Metric. 24 sizes. Sale \$36.19 **Tool Club \$28.95**



**KDT3887 77pc Ratcheting SAE/Metric Tap & Die Set**

Includes 18 Taper Taps, 14 Plug Taps, 34 Hex Dies, Medium ratcheting T-wrench, 2 tap adapters, medium hex die adapter, sliding handle for tap adapter, 4mm hex key, 2 thread pitch gauges & hex die spacer. Sale \$228.69 **Tool Club \$182.95**



**LANG2599 20pc Axle Rethreader**

Will repair threads on most axles. Includes: 11/16"-24, 3/4"-16, 3/4"-20, 13/16"-20, 27/32"-20, 7/8"-14, 1"-14, M16x1, M16x1.5, M18x1.5, M19x1.5, M20x1, M20x1.25, M20x1.5, M22x1.5, M22x1.5, M24x1.5, M24x2, M25x1.5, M27x2 Sale \$114.06 **Tool Club \$91.25**



**IRWIN. TAP & DIE SETS**



**IWN26376 76pc Tap & Hex Die Set Machine Screw/SAE/METRIC** 3mm to 12mm. #4 to 1/2" plus tools. Sale \$336.19 **Tool Club \$268.95**



**IWN26394 53pc METRIC Tap & Hex Die Set** Tap: 3mm to 12mm; Dies: 3mm to 18mm Sale \$396.25 **Tool Club \$317.00**



**IWN24606 41pc SAE Tap & Hex Die Set** #4 to 1/2" plus tools. Sale \$201.88 **Tool Club \$161.50**



**IWN26317 41pc METRIC Tap & Hex Die Set** 3mm to 12mm plus tools. Sale \$204.19 **Tool Club \$163.35**

**SCREW EXTRACTORS**

**IRWIN**

**IWN3101010**  
**48pc Master Extractor Set**  
 Includes  
 6 spiral extractors, 13 Stubby extractors,  
 16 left-handed drill bits & 13 stud/bolt removers.  
 Sale \$375.31 **Tool Club \$300.25**



**IWN53227**  
**25pc Stubby Extractor Set**  
 Sizes: 1/8" to 7/8"  
 Sale \$100.00  
**Tool Club \$80.00**

**IRWIN**



**IWN53535**  
**5pc Spiral Extractor**  
 Sizes: 3/32" to 5/8"  
 Sale \$17.81  
**Tool Club \$14.25**



**IWN30520**  
**5pc Left-Handed Drill Set**  
 Sale \$41.88  
**Tool Club \$33.50**



**KDT2419D**  
**4pc Spiral Extractor Set**  
 For bolts: #12 to 3/4".  
 Sale \$19.94  
**Tool Club \$15.95**



**KDT720DD**  
**5pc Fluted Extractor Set**  
 For bolts: 1/4" to 5/8"  
 Sale \$27.44  
**Tool Club \$21.95**



**TIT11215**  
**3pc Double-Ended Screw Extractor Set**  
 For 4-14 screws & up to 5/16" bolts.  
 Sale \$14.38 **Tool Club \$11.50**

**TITAN**



**WILW2968**  
**8pc Screw Extractor Set**  
 Sizes: #1 - #8.  
 Sale \$17.81  
**Tool Club \$14.25**



**LIS61980**  
**10pc Stripped Screw Extractor Set**  
 Removes rounded or stripped fasteners with internal drive heads.  
 Sale \$48.75  
**Tool Club \$39.00**



**MAYHEW**  
 The Power Force

**MAY37345**  
**10pc Screw & Pipe Extractor Set**  
 • Removes broken screws, bolts, & stud pipes.  
 • Covers a range of 1/4" - 1-1/2".  
 • Includes storage case.  
 Sale \$133.69 **Tool Club \$106.95**



**KDT84787**  
**4pc Bolt Biter™ Screw Extractor Set**  
 Compatible with fastener sizes ≤ 1/4" - 5/8" & M5-M16.  
 Bi-directional design loosens or tightens damaged fasteners.  
 Sale \$31.19 **Tool Club \$24.95**

**NEW!**



**KDT84786**  
**10pc Bolt Biter™ Screw Extractor Set**  
 Compatible with fastener sizes ≤ 1/4" - 5/8" and M5-M16.  
 5 Sizes of left-hand drill bits included for extraction needs from start to finish. Bi-directional design loosens or tightens damaged fasteners. Comes with customizable & stackable storage case.  
 Sale \$83.69 **Tool Club \$66.95**

**NEW!**



**IWN53226**  
**10pc Spiral Flute Screw Extractor Set**  
 Screw Range 1/8 to 13/32"  
 Sale \$40.31 **Tool Club \$32.25**

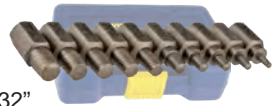

**IWN11119**  
**10pc Spiral Flute Screw Extractors**  
 5 lefthand cobalt drill bits  
 5 spiral extractors; Sizes: 1-5  
 Sale \$61.19 **Tool Club \$48.95**

**IRWIN**



**CHPX1-XL5LH**  
**Left Hand Heavy Duty Drill/Screw Extractor Set**  
 Sizes: 5/64, 7/64, 5/32, 1/4, 19/64  
 Screw extractors: #1-5  
 Sale \$106.19  
**Tool Club \$84.95**

**CHAMPION**  
 CUTTING TOOL CORP.



**TIT16013**  
**10pc Extractor Set**  
 5 spiral extractors & 5 titanium coated left hand drill bits.  
 Sale \$21.88  
**Tool Club \$17.50**

**TITAN**



**MAY37331**  
**4pc Extractor Set**  
 Square screw extractors for large screws.  
 Sale \$54.94  
**Tool Club \$43.95**



**MAYHEW**  
 The Power Force



**MAY37332**  
**5pc Extractor Set**  
 Square screw extractors for smaller screws.  
 Sale \$32.44 **Tool Club \$25.95**



**IWN3073004**  
**17pc Hole Saw Kit**  
 Sizes: 5/8" to 3".  
 Includes arbors.  
 Sale \$144.06  
**Tool Club \$115.25**



**IRWIN**

**STUD EXTRACTORS**

**LIS19250**

**6pc Stud Remover & Installer**  
 Removes studs, nuts and bolts 1/4, 5/16, 3/18, 7/16, 1/2, 9/16, 6, 8, 10, 11, 13, & 14mm  
 Sale \$53.44 **Tool Club \$42.75**



**KDT41760D**

**8pc SAE/Metric Stud Removal Set**  
 Sizes: 6, 8, 10, 12mm  
 1/4", 5/16", 3/8", 7/16"  
 Sale \$93.44 **Tool Club \$74.75**



**MAY29895**

**3/8" Stud Extractor**  
 Fits 1/4" to 1/2" (6 - 12mm) studs. Impact gun compatible.  
 Sale \$96.19 **Tool Club \$76.95**

**NEW!**

**MAYHEW**



**TIT16023**

**3/8" Stud Extractor**  
 Fits 1/4" to 1/2" (6 - 12mm) studs. Impact gun compatible.  
 Sale \$26.88 **Tool Club \$21.50**



**CARBIDE BURR SETS**

**CHBK8P-RE**

**8pc Titanium Carbide Burr Kit**  
 Sizes: SD3, SD1, SC1, SC3, SA3, SA5, SF3 & SF5  
 Sale \$237.44  
**Tool Club \$189.95**



**CHAMPION**  
 CUTTING TOOL CORP.



**AST2181**

**8pc Carbide Burr**  
 Fits die grinders.  
 Sale \$99.94  
**Tool Club \$79.95**



**NEW!**

**AST2185**

**5pc Long Double Cut Carbide Burr Set - 4.5"**  
 1/4" shank. 4.5" Long.  
 Sale \$99.94 **Tool Club \$79.95**



**CHAMPION**  
 CUTTING TOOL CORP.

**CHPSA80-SET**

**3pc Maintenance Reamers**  
 1/2" straight shank.  
 Sizes: 1/2", 5/8", & 3/4".  
 Sale \$237.44 **Tool Club \$189.95**



**LUG NUT DRILLER**

**CTA1775**

**Lug Driller**  
 Remove the most difficult locking lug bolts quickly, safely & without damage to wheel or rim.  
 Sale \$437.44  
**Tool Club \$349.95**





## UNIBITS IRWIN.

**IWN10502**  
3pc Unibit Set  
Sizes: #1, #2, & #3  
Sale \$116.56  
**Tool Club \$93.25**

**IWN10234**  
#4 Unibit  
Sizes: 3/16" to 7/8"  
Sale \$67.19  
**Tool Club \$53.75**

**IWN10235**  
#5 Unibit  
Sizes: 1/4" to 1-3/8"  
Sale \$116.56  
**Tool Club \$93.25**

**TIT16503**  
3pc Step Drill Set  
Sale \$26.88  
**Tool Club \$21.50**

**TIT11170 TITAN**  
170pc Titanium  
Coated Drill Bit Set  
19 different drill bit sizes.  
Lasts up to six times  
longer than a normal bit.  
Sale \$119.38  
**Tool Club \$95.50**

**CHPXL12-8P**  
8pc Platinum  
S&D Drill Set  
1/2" shank.  
Sizes:  
9/16" - 1" x 16ths.  
High speed steel.  
Sale \$324.94 **Tool Club \$259.95**

**IWN90108 IRWIN.**  
8pc Reduced  
Shank Bits  
Sizes: 9/16", 5/8",  
11/16", 3/4", 13/16",  
7/8", 15/16", 1". With 1/2" shanks to fit 1/2" drills.  
Sale \$288.69 **Tool Club \$230.95**

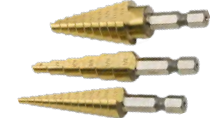

## DRILL BIT SETS

**CHPTWISTER-XL28**  
29pc Brute Platinum  
Drill Bit Set  
Sizes: 1/16" - 1/2" x 64ths.  
Mechanic's length bits  
with flattened shank. 135°  
split point drills accurately.  
Ultimate workhorse for  
drilling through tough alloys  
including stainless steel!  
Sale \$162.44  
**Tool Club \$129.95**



**CHPTWISTER-XGO**  
29pc BlackGold®  
Drill Bit Set  
Sizes: 1/16" - 1/2" x 64ths.  
Recommended for drilling  
stainless steels, titanium  
alloys and hard steel.  
Sale \$149.94  
**Tool Club \$119.95**



**SVT63106**  
29pc Stepped  
Cutter Drill Bit Set  
Sizes: 1/16" - 1/2".  
Outlasts split point bits 4-1.  
Never needs pilot hole.  
Mechanics length makes  
them less prone to breakage.  
Sale \$312.44  
**Tool Club \$249.95**



**IWN3018002B**  
29pc Cobalt Drill Bit Set  
Sizes: 1/16" - 1/2". Constructed  
of M-42 8% cobalt high  
speed steel for super abrasive  
resistance in tough metals  
Tap & Drill selection chart  
included. Removable cartridges.  
Sale \$233.69  
**Tool Club \$186.95**



## BOLT & NUT EXTRACTORS

**AST7402** **NEW!**  
2pc 1/2" Dr. Double End Wheel Lock  
& Lug Nut Removal Socket Set  
Sizes: 3/4" (19mm) & 13/16" (21mm),  
7/8" (22mm) & 15/16" (24mm).  
Sale \$53.69 **Tool Club \$42.95**



**AST7404**  
4pc Flank Bite Damaged Lug Nut Socket Set  
Protective sleeves free spin instead of  
scuffing wheels. Sizes: 17mm, 19mm (3/4"),  
21mm (3/16"), & 22mm.  
Sale \$49.94 **Tool Club \$39.95**

**IWN394002**  
5pc Bolt & Nut Remover  
Reverse spiral flutes  
provide maximum  
gripping power.  
Sizes: 5/16" to 3/4"  
Sale \$43.69 **Tool Club \$34.95**



**IWN394001**  
5pc Bolt &  
Nut Remover  
Reverse spiral flutes  
provide maximum  
gripping power.  
Sizes: 3/8" to 5/8"  
Sale \$51.56 **Tool Club \$41.25**



**IWN3094001**  
5pc DEEP  
Bolt/Nut Remover  
Extra deep sizes: 3/8",  
7/16", 1/2", 9/16" & 5/8"  
Sale \$57.81 **Tool Club \$46.25**



## BOLT BITER™

- Bi-Directional Design for Removing or Tightening Damaged SAE & Metric Fasteners
- Tapered Entry Enables Socket to Easily Seat on a Damaged SAE & Metric Fastener
- Up to 10x Longer Impact Life vs. Competition

### GW GEARWRENCH

**KDT84782** **NEW!**  
8pc 1/4" & 3/8" Drive  
Bolt Biter™ Impact Extraction Socket Set  
Sizes: 7mm, 8mm [5/16"], 10mm, 11mm [7/16"],  
12mm, 13mm, 14mm [9/16"], 16mm [5/8"]  
Sale \$62.44 **Tool Club \$49.95**



**KDT86070** **NEW!**  
5pc 1/2" Dr. Bolt Biter™  
Deep Extraction Socket Set  
Sizes: 19mm [3/4"] - 25mm [1"]  
Sale \$106.19 **Tool Club \$84.95**



**KDT84783** **NEW!**  
15pc 1/4" & 3/8"  
Drive Bolt Biter™  
Impact Extraction Socket Set  
Sizes: 1/4", 7mm, 8mm [5/16"], 3/8", 10mm, 11mm  
[7/16"], 12mm, 13- mm [1/2"], 13mm, 14mm [9/16"],  
14mm [9/16"], 9/16", 16- mm [5/8-"], 16mm [5/8"],  
9/16", 16mm [5/8"], 17mm, 11/16", 19mm [3/4"]  
Sale \$172.44 **Tool Club \$137.95**



**KDT86171** **NEW!**  
16pc Bolt Biter™ Nut Extractor & Driver Set  
Sizes: 1/4"-, 1/4", 7- mm, 7mm, 8- mm [5/16-"],  
8mm [5/16"], 3/8"-, 3/8", 10- mm, 10mm, 11- mm,  
11mm, 12- mm, 12mm, 1/2"-, 13 mm [1/2"].  
Sale \$162.44 **Tool Club \$129.95**



**KDT84784** **NEW!**  
28pc 1/4" & 3/8" Dr.  
Bolt Biter™ Impact Extraction Socket Set  
Sizes: 1/4"-, 1/4", 7- mm, 7mm, 8- mm [5/16-"],  
8mm [5/16"], 3/8"-, 3/8", 10- mm, 10mm, 11- mm, 11mm,  
12- mm, 12mm, 1/2"-, 13- mm [1/2"], 13mm, 14- mm,  
12- mm, 12mm, 1/2"-, 13- mm [1/2"], 13mm, 14- mm,  
17- mm, 17mm, 11/16"-, 11/16".  
Sale \$312.44 **Tool Club \$249.95**



**KDT86525**  
31pc 3/8" Dr. Bolt Biter™  
Socket Set  
Includes 90 Tooth Ratchet,  
3" ext., 1/4" F x 3/8" M adapter  
& EVA foam tray. Bi-directional  
design loosens or tightens  
damaged fasteners. Dual sized sockets designed to  
work with both SAE/Metric fasteners.  
Sale \$262.44 **Tool Club \$209.95**





**OTC6522 LeakTamer™ EVAP Smoke Machine**

80% of top codes can be diagnosed with smoke technology. UltraTrace UV dye - OE approved. New smoke flow control adjusts for specific applications. Detects microleaks to & below .010". Sale \$1,374.94 **Tool Club \$1,099.95**



**LIS69910 14pc Turbo Air System Test Kit with Smoke Adapter**

Includes T-adapter for connecting smoke machines to help locate air leaks in the components. Plugs the output side of the turbo and the intake inlet. Air and smoke are applied through one adapter to show the presence of leaks within the system. Can also be used on some cooling system hoses. Sale \$288.69 **Tool Club \$230.95**

**SMOKE MACHINES**



**MSC43060-HD H.D. Truck Diagnostic Smoke Machine**

Operates on shop air or inert gas. Quick smoke generation. Built-in safety pressure relief valve. Pressure can be regulated from 0 - 28PSI. Large easy to read pressure decay gauge 0 - 30PSI. Sale \$1,362.44 **Tool Club \$1,089.95**



**RED95-0082 Easy INTAKE™**

Inflatable block off bladder with a pressurized vapor pass-through system to test the entire intake or exhaust system quickly & easily. Sale \$149.94 **Tool Club \$119.95**



**OTCP0716UV UltraTraceUV Dye Smoke Solution**

Will not harm activated charcoal canister, ORVR valve, purge valve, vent valve, catalytic converters, O2 sensors, seals, or gaskets. Sale \$124.94 **Tool Club \$99.95**



**RED95-0003C Smoke Pro Total Tech**

Fid leaks and sell repairs with visual confirmation. Full featured diagnostic capabilities to detect, locate & repair leaks. Sale \$1,312.44 **Tool Club \$1,049.95**

**RED95-0030 EASYEVAP™ Universal Filler Neck Connector**

In seconds, this versatile adaptor creates an air-tight seal with any vehicle's EVAP system, eliminating the need for searching for the EVAP service port. Sale \$149.94 **Tool Club \$119.95**



**RED96-0017-40 Sealing Disks - Pack of 40**

To ensure air-tight seals, utilize these with the Universal Filler Neck Connector. Sale \$62.44 **Tool Club \$49.95**



**DRILL MANIFOLDS**



**LIS72350 Manifold Drill Template for Ford 7.3 Diesel**  
Removes broken exhaust manifold bolts by drilling without damaging the cylinder head. Sale \$170.63 **Tool Club \$136.50**



**LIS71500 Dodge 5.7L Hemi Manifold Drill Template**  
The screw extractor is then used to remove the broken bolt. Includes bushing to drill to tap size when extractor cannot be used. Double sided drill depth gauge to make sure water jacket is not pierced. Sale \$169.69 **Tool Club \$135.75**



**LIS72600 Dodge 4.7L Manifold Drill Template**  
Removes broken exhaust manifold bolts on Dodge® 4.7L motors without damaging the cylinder head. Sale \$194.38 **Tool Club \$155.50**



**LIS72400 Manifold Drill Template for Duramax 6.6L Diesel**  
Removes broken exhaust manifold bolts by drilling without damaging the cylinder head. Sale \$170.63 **Tool Club \$136.50**



**LIS71600 Ford 4.6L / 5.4L Manifold Drill Template**  
Removes broken exhaust manifold bolts by drilling without damaging the cylinder head. Sale \$224.94 **Tool Club \$179.95**



**LIS71400 GM 4.8L, 5.3L & 6.0L Manifold Drill Template**  
Double sided drill depth gauge to make sure water jacket is not pierced. Removes broken exhaust manifold bolts by drilling without damaging the cylinder head. Sale \$149.94 **Tool Club \$119.95**



**LIS71350 Ford 6.0L/6.4L Manifold Drill Template**  
Removes broken exhaust manifold bolts by drilling without damaging the cylinder head. Sale \$166.19 **Tool Club \$132.95**



**LIS68500 Ford Manifold Drill Template**  
Designed to remove broken exhaust manifold studs on 4.6L, 5.4L & 6.8L V10 2 valve & 3 valve Ford Triton engines without damaging the cylinder head. Sale \$124.94 **Tool Club \$99.95**



**LIS71650 GM 5.3L & 6.2L Manifold Drill Kit**  
Removes broken exhaust manifold bolts on GM EcoTech 3 5.3L & 6.2L motors without damaging the Cylinder Head. Removes broken manifold bolts. Sale \$156.88 **Tool Club \$125.50**

## O-RING SET



**WILW5202**  
407pc O-Ring Set  
SAE Sizes  
Sale \$22.44  
**Tool Club \$17.95**

**WILW5203**  
407pc O-Ring Set  
METRIC Sizes  
Sale \$22.44  
**Tool Club \$17.95**

**WILW5201**  
270pc HNBR  
O-Ring Set  
For applications requiring higher resistance to chemicals and higher temperatures than NBR.  
Sale \$13.13  
**Tool Club \$10.50**

## FUSES

**TIT45227**  
96pc ATO Fuse Assortment  
For wiring up custom applications and replacing blown fuses.  
Sale \$13.13  
**Tool Club \$10.50**



**TIT45229**  
96pc Mini Fuse Assortment  
3 Amp to 30 Amp  
Sale \$15.63  
**Tool Club \$12.50**



**TIT45230**  
88pc Master Fuse Assortment  
Mini & Maxi standard fuses.  
Sale \$22.44  
**Tool Club \$17.95**



**TIT45232**  
24pc Maxi Fuse Assortment  
Sale \$24.38  
**Tool Club \$19.50**



**NEW!**

**WILW5374**  
16pc Maxi Fuse Assortment  
Sale \$21.19  
**Tool Club \$16.95**



**WILW5204**  
1,000pc Cotter Pin Assortment  
Sale \$16.19  
**Tool Club \$12.95**



**WILW5214**  
125pc Rubber Grommet Assortment  
Sale \$11.19  
**Tool Club \$8.95**

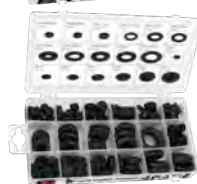

**WILW5215**  
70pc Grease Fitting Assortment  
Sale \$14.94  
**Tool Club \$11.95**



**WILW5216**  
350pc Lock & Flat Washer Assortment  
Sale \$9.38  
**Tool Club \$7.50**



**WILW5221**  
347pc SAE Nuts & Bolts Assortment  
Sale \$9.38  
**Tool Club \$7.50**



**WILW5222**  
347pc Metric Nuts & Bolts Assortment  
Sale \$9.38  
**Tool Club \$7.50**



**WILW5226**  
1,200pc Nut & Bolt Assortment  
Sale \$49.94  
**Tool Club \$39.95**



**WILW5230**  
1,000pc Steel Hog Rings  
Sale \$13.69  
**Tool Club \$10.95**



**WILW5213**  
160pc Wire Terminal Asst.  
Sale \$18.69  
**Tool Club \$14.95**



**EPPWTA**  
285pc Wire Terminal Assortment  
285 pcs. 18 types of solderless connectors.  
Sale \$33.69  
**Tool Club \$26.95**



**TIT85527**  
80pc Poly Rivet Assortment Set  
Industrial strength poly rivets protect painted & delicate surfaces.  
Sale \$18.69  
**Tool Club \$14.95**



**EZRHS34**  
157pc Heat Shrink Set  
8 different size tubes that shrink to fit over cable splices.  
Sale \$21.19  
**Tool Club \$16.95**



**NEW!**

**WILW5220**  
200pc Hex Washer Self Drilling Screws  
Sale \$11.88  
**Tool Club \$9.50**



**TIT45274**  
110 pc Grease Fitting Assortment  
Sale \$19.38  
**Tool Club \$15.50**



**WILW5208**  
300pc E-Clip Assortment  
Contains 9 various popular sizes.  
Sale \$11.19  
**Tool Club \$8.95**

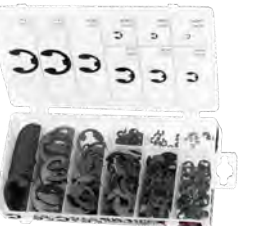

**WILW5209**  
24pc Alligator Clip Assortment  
Make your own low voltage jumper leads.  
Sale \$12.44 **Tool Club \$9.95**

**WILW5200**  
200pc Spring Assortment  
Contains 20 popular sizes of springs.  
Sale \$12.44 **Tool Club \$9.95**



## HOSE CLAMPS

**WILW5348**  
26pc Hose Clamp Assortment  
Sale \$9.94  
**Tool Club \$7.95**



**TIT45207**  
20pc Large Hose Clamp Assortment  
Sale \$17.19  
**Tool Club \$13.75**



**WILW5231**  
26pc Key Type Hose Clamps  
No tool necessary. 4 different sizes.  
Sale \$13.69  
**Tool Club \$10.95**



**LATEX GLOVES**



SAS650-1002 Medium  
 SAS650-1003 Large  
 SAS650-1004 XLarge  
 SAS650-1005 XXLarge  
**Dyna Grip Latex Gloves**  
 • Thickness: 7 mil.  
 • Beaded cuff.  
 • Fully textured for excellent grip.  
 • 100 gloves per box.  
 Sale \$23.69 **Tool Club \$18.95**



SAS6602 - Medium  
 SAS6603 - Large  
 SAS6604 - XLarge  
 SAS6605 - XXLarge  
**Thickster Latex Gloves**  
 • Thickness: 14 mil. 12" length for added protection.  
 • Fully textured for superior grip.  
 • 50 gloves per box.  
 Sale \$23.69 **Tool Club \$18.95**

**NITRILE GLOVES**



SAS66517 Medium  
 SAS66518 Large  
 SAS66519 XLarge  
 SAS66520 XXLarge  
**Raven Nitrile Gloves**  
 • Thickness: 7 mil.  
 • Outstanding strength, wear, and dexterity.  
 • Fully textured grip.  
 • 100 gloves per box.  
 Sale \$27.44 **Tool Club \$21.95**



SAS66572 Medium  
 SAS66573 Large  
 SAS66574 XLarge  
 SAS66575 XXLarge  
**Astro Grip Nitrile Gloves**  
 • Thickness: 8 mil.  
 • Dual-sided scale textured surface for superior grip.  
 • Hi-vis orange color.  
 • 100 gloves per box.  
 Sale \$30.63 **Tool Club \$24.50**

**LIS20130**

**Glove Box Holder**  
 Magnets will hold this to a tool box, or mount it to a wall with the holes provided.  
 Sale \$31.25  
**Tool Club \$25.00**



**JAC14230**

**QUAD 500™ Premium Multi-Purpose Face Shield**  
 Extra-large window provides superior panoramic view. Premium STA-Clear anti-fog coating. Integrated side & chin guard. Shade 5 flip-up visor.  
 Sale \$95.31  
**Tool Club \$76.25**



**SURS32151**

**Multi-Purpose Face Shield w/ Flip-Up IR Window & Ratcheting Headgear**  
 Includes stylish crown, full 9" x 12-1/8" x 0.060" molded polycarbonate AF window, 4-3/8" x 9-1/4" x 0.070" flip-up/flip-down IR visor & premium ratcheting headgear suspension.  
 Sale \$82.44 **Tool Club \$65.95**



**JAC50000**

**Safety Glasses w/ Black Frame & Clear Lens**  
 Sale \$8.13 **Tool Club \$6.50**



**JAC50002**

**Safety Glasses w/ Black Frame & Clear Lens**  
 Sale \$8.13 **Tool Club \$6.50**



**JAC50006**

**Safety Glasses w/ Black Frame & Clear Lens**  
 Sale \$9.06 **Tool Club \$7.25**



**MECHANIC'S GLOVES**

**KDT86987 Heavy Impact Work Gloves - L**  
 Sale \$37.44  
**Tool Club \$29.95**



- Machine washable.
- Extended cuff with hook and loop closure.
- 90 day limited warranty.

**GW GEARWRENCH IMPACT READY**

**KDT86988 Heavy Impact Work Gloves - XL**  
 Sale \$37.44  
**Tool Club \$29.95**



**LIS89910 Mechanic's Gloves - L**

Non-padded, single layer palm & tough spandex top material  
 Sale \$35.63  
**Tool Club \$28.50**



**LIS89920 Mechanic's Gloves - XL**

Non-padded, single layer palm & tough spandex top material  
 Sale \$35.63  
**Tool Club \$28.50**



**BLA-CPT100 - Medium**

**BLA-CPT120 - Large**  
**BLA-CPT130 - XL**  
**BLA-CPT140 - 2XL**  
**Black Mamba H.D. Impact Protection Work Gloves**  
 3D curved Fingers. 7mm High Anti-Impact Protection. TPR Knuckle Protection. High Visibility Yellow Color.  
 Sale \$20.31  
**Tool Club \$16.25**



**SAS6478**

**Electric Service Glove Kit - L**  
 Includes 1 pair of electrical service gloves & protective over gloves.  
 Sale \$131.19  
**Tool Club \$104.95**



**SAS6479**

**Electric Service Glove Kit - XL**  
 Includes 1 pair of electrical service gloves & protective over gloves.  
 Sale \$131.19  
**Tool Club \$104.95**



**SURS96110**

**KneePro Ultra Flex III Knee Pads**  
 Articulating hinged design. Replaceable grip strips. Virtually indestructible. Quick-snap clips for easy removal.  
 Sale \$43.13 **Tool Club \$34.50**



**WIPES**



**TUB-TX90 TUB O' TOWELS**  
**Tub O' Towels All Purpose Wipes**  
 90 count tub. 10" x 12" cleaning surface. Perfect for all your cleanup needs at home and in the shop. Tough cleaning solution.  
 Sale \$21.19 **Tool Club \$16.95**

## SOCKET HOLDERS

Universal Twist-Lock Socket Set Organizer Tray w/ 2 Socket Rails



Part #	Type	Size	Sale	Club
ERN8461HV	Custom	1/4"	\$25.94	\$20.75
ERN8462HV	Custom	3/8"	\$25.94	\$20.75
ERN8463HV	Custom	1/2"	\$25.94	\$20.75

**TITAN** Socket Rails are made of anodized aluminum. Magnetic backing.



Part #	Size	Sale	Club
TIT36097	1/4" SAE	\$17.81	\$14.25
TIT36098	1/4" METRIC	\$17.81	\$14.25
TIT38097	3/8" SAE	\$29.06	\$23.25
TIT38098	3/8" METRIC	\$29.06	\$23.25
TIT32097	1/2" SAE	\$31.56	\$25.25
TIT32098	1/2" METRIC	\$31.56	\$25.25

**KANSEN** Socket Rails are MADE IN USA. Built to hold short and deep sockets.



Part #	Size	Sale	Club
HG1401	1/4" SAE	\$14.06	\$11.25
HG1402	1/4" METRIC	\$14.06	\$11.25
HG3801	3/8" SAE	\$14.06	\$11.25
HG3802	3/8" METRIC	\$14.38	\$11.50
HG1201	1/2" SAE	\$15.63	\$12.50
HG1202	1/2" METRIC	\$15.63	\$12.50

**ATA** Socket Rails are spring loaded, color coded & show the socket sizes.



Part #	Size	Sale	Club
CTA9720	1/4" SAE	\$8.44	\$6.75
CTA9725	1/4" METRIC	\$8.44	\$6.75
CTA9730	3/8" SAE	\$8.44	\$6.75
CTA9735	3/8" METRIC	\$8.44	\$6.75
CTA9750	1/2" SAE	\$13.13	\$10.50
CTA9755	1/2" METRIC	\$13.13	\$10.50

## ORGANIZER TRAYS

**NEW!**

**ERN5505HV**  
10 Tool Plier Pro  
Premium rubber base grips tools & drawers. Accommodates a wide variety of tools, holds 10. Sale \$21.88 **Tool Club \$17.50**

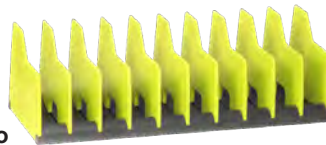

Part #	Space	Size	Sale	Club
ERN5023HV	3	10.5" x 10.5"	\$12.19	\$9.75
ERN5017HV	10	11" x 16"	\$15.63	\$12.50

## WRENCH RACKS



**EZRWR10-RD**  
Magnetic Wrench Rack - Red  
Holds 10 wrenches. Individual magnet design holds any size wrench; flex-head and stubbies. Sale \$24.94 **Tool Club \$19.95**



Part #	Pcs.	Type	Size	Sale	Club
ERN5082HV	15	Combo	Custom	\$12.19	\$9.75
ERN5062HV	16	Combo	Custom	\$12.19	\$9.75
ERN5065HV	19	Combo	Custom	\$12.19	\$9.75
ERN5068HV	15	Combo	Custom	\$11.69	\$9.35

**ERN8512HV**  
Socket Boss Hi-Viz Combo Pack  
Includes 1/4", 3/8" and 1/2" rails. Sale \$61.56 **Tool Club \$49.25**

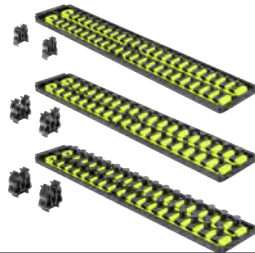

Part #	Pcs.	Type	Sizes	Sale	Club
HG5301	13	SAE	1/4" - 15/16"	\$10.63	\$8.50
HG5302	13	METRIC	6 - 18mm	\$10.63	\$8.50
HG5300	13	Combo	Custom	\$10.63	\$8.50
TIT98013	13	SAE	1/4" - 1"	\$7.44	\$5.95
TIT98012	12	METRIC	8 - 19mm	\$7.44	\$5.95



Will hold up to 13 tools. Two different sizes of slots.

**LIS40460**  
Pliers / Wrench Rack - Black  
Sale \$20.63 **Tool Club \$16.50**

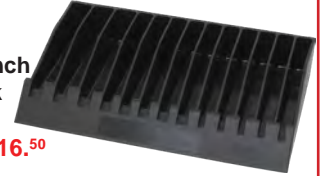

**LIS40490**  
Pliers / Wrench Rack - Red  
Sale \$20.63 **Tool Club \$16.50**



**ERN6060**  
44 Tool Combo Pack "No Slip"  
Low Profile Wrench & Screwdriver Sets  
Holds 30 wrenches & 14 screwdrivers. Trims easily for a custom fit. Sale \$34.06 **Tool Club \$27.25**



**LIS49490**  
24" Locking Tool Holder  
Holds up to 13 tools, including pry bars, extensions and air tools. Sale \$67.19 **Tool Club \$53.75**

## MAG RAILS



Part #	Size	Sale	Club
VIMMR8G	8" Green	\$21.19	\$16.95
VIMMR8B	8" Blue	\$21.19	\$16.95
VIMMR8R	8" Red	\$21.19	\$16.95
VIMMR12G	12" Green	\$31.19	\$24.95
VIMMR12B	12" Blue	\$31.19	\$24.95
VIMMR12R	12" Red	\$31.19	\$24.95
VIMMR16G	16" Green	\$36.56	\$29.25
VIMMR16B	16" Blue	\$36.56	\$29.25
VIMMR16R	16" Red	\$36.56	\$29.25
VIMMRD20BK	20" Black	\$44.38	\$35.50
VIMMRBITBASE	38" Base	\$33.69	\$26.95

STUD & T-NUTS FOR MAG RAIL



Part #	Size	Sale	Club
VIMMR-SA	1/4" 10PK	\$4.69	\$3.75
VIMMR-SB	3/8" 10PK	\$5.31	\$4.25
VIMMR-SC	1/2" 10PK	\$6.88	\$5.50
VIMMR-SD	3/4" 10PK	\$8.13	\$6.50
VIMMR-SE	1" 10PK	\$9.06	\$7.25

**SUNEX<sup>®</sup>**  
TOOLS

OTHER  
COLORS  
AVAILABLE!

25"D x 38"W x 45"H



**SUN8057BK - Black**  
Professional Service Cart

- 600lb. Capacity
- Full extension roller bearing drawer slides.
- 6 drawers with locking top bin
- 5" x 2" heavy duty casters; 2 locking
- H.D. 18 gauge steel construction
- Locking top bin with gas shocks to raise and support lid.

Sale \$1,186.88 **Tool Club \$949.50**

**Beta** Professional Hand Tools 37.6"H x 29"W x 17.5"D



Mobile Roller Cabinets w/ Eight Drawers

**BETA024002681 - Orange**  
Sale \$874.94 **Tool Club \$699.95**

**BETA024002682 - Grey**  
Sale \$874.94 **Tool Club \$699.95**

**BETA024002686 - Blue**  
Sale \$874.94 **Tool Club \$699.95**

**EXTREME TOOLS**  
BUILT TO THE EXTREME  
44.5"H x 23"D x 33"W



OTHER  
COLORS  
AVAILABLE!

**NEW!**

**EXT-EX3304TCRDBK**  
33" 4 Drawer Deluxe Tool Cart  
Red w/ Black Drawer Pulls  
4 drawers with 3-segment, quick-release ball bearing slides. Rated 100lbs per drawer. Size: 33"W x 22.875"D x 44.25"H  
Sale \$1,465.63 **Tool Club \$1,172.50**

**H.D. TOOL BOXES**

**EXTREME TOOLS**  
BUILT TO THE EXTREME

- Ball bearing drawer slides • High gloss powder coat finish
- Drawers rated from 100 - 200 lbs • Includes drawer liners
- Full width drawer pulls • Polished chrome trim



Part #	Color	Size	Desc.	Sale	Club
EXT-RX412508CHBK	Black	41"	Top	\$1,498.75	<b>\$1,199.00</b>
EXT-RX412511RCBK	Black	41"	Bottom	\$1,998.75	<b>\$1,599.00</b>
EXT-RX412508CHBL	Blue	41"	Top	\$1,498.75	<b>\$1,199.00</b>
EXT-RX412511RCBL	Blue	41"	Bottom	\$1,998.75	<b>\$1,599.00</b>
EXT-RX552508CHBK	Black	55"	Top	\$2,123.75	<b>\$1,699.00</b>
EXT-RX552512RCBK	Black	55"	Bottom	\$3,373.75	<b>\$2,699.00</b>
EXT-RX552508CHBL	Blue	55"	Top	\$2,123.75	<b>\$1,699.00</b>
EXT-RX552512RCBL	Blue	55"	Bottom	\$3,373.75	<b>\$2,699.00</b>



- Auto return ball bearing slides rated 100lb capacity
- Easy lid opening & closing with gas charged lift supports
- Textured coated paint finish for corrosion, weather & staining resistance

Part #	Size	Desc.	Sale	Club
KDT83240	26"	Top	\$611.88	<b>\$489.50</b>
KDT83241	26"	Bottom	\$874.94	<b>\$699.95</b>
KDT83242	36"	Top	\$912.44	<b>\$729.95</b>
KDT83243	36"	Bottom	\$1,124.94	<b>\$899.95</b>
KDT83244	41"	Top	\$937.44	<b>\$749.95</b>
KDT83245	41"	Bottom	\$1,499.94	<b>\$1,199.95</b>

OTHER  
COLORS  
AVAILABLE!

**GW GEARWRENCH**

**NEW!**

35" L  
x  
20" W  
x  
39" H



**KDT83246**  
35" 7 Drawer GSX Series  
Rolling Tool Cart with Tilt Top  
Built-in charging station with 4 outlets, 2 USB ports and an on/off switch. 20 gauge steel cabinet body. Equipped with black foam liners for each drawer and top storage space. 450lbs weight rating per caster. Sale \$1,437.44 **Tool Club \$1,149.95**

# EXTREME TOOLS

BUILT TO THE EXTREME



- Full-extension drawers to access every part of the drawer.
- Ball bearing slides loaded rated 100-200 lbs. per drawer.
- Quick Release, self-latching drawer pulls.
- 6" x 2" Mag Wheel Casters that support up to 900 lbs. each.
- 14-gauge steel bottom frame to support a fully-loaded tool box.
- Matching side handles & trim. Professional quality PVC drawer liners.

Shown with Hutch  
and Side Box



## 72" Tool Box w/ 17 Drawer 21" Deep Roller Cabinet

- EXT-DX722117RCBKBL
- EXT-DX722117RCBKRD
- EXT-DX722117RCBLBK
- EXT-DX722117RCGRBK
- EXT-DX722117RCMBBK
- EXT-DX722117RCORBK

- Black w/ Blue Drawer Pulls
- Black w/ Red Drawer Pulls
- Blue w/ Black Drawer Pulls
- Green w/ Black Drawer Pulls
- Matte Black w/ Black Drawers
- Orange w/ Black Drawer Pulls

Sale \$2,998.75  
**Tool Club \$2,399.00**

72"W x 21"D x 42.75"H  
Tubular Coded Lock and Keys

Tool Box Hutch  
EXT-DX722101HCBKBL  
Deep Triple Bank Hutch Black  
w/ Blue Handle / Drawer Pulls

71 15/16"W x 21"D x 22 1/4"H  
Sale \$1,499.06  
**Tool Club \$1,199.25**

Side Box  
EXT-DX192100SLBKBL  
Deep Side Locker with  
4 Shelves Black w/ Blue Handle

19"W x 21"D x 56.34"H  
Sale \$1,437.44  
**Tool Club \$1,149.95**

Tool Box, Hutch & Side Box: **Tool Club \$4,699.95**

# EXTREME TOOLS

BUILT TO THE EXTREME

## 41" TOOL CART / BOX

41.75W x 25.75"D x 43"H



- 6 Drawers
  - Only One Drawer Opens at One Time
  - 100 lbs Drawer Capacity per Set of Slides
  - PVC Drawer Liners Included
  - Tubular Coded Locks and Keys
  - Drawers Can be Opened without Top Lid Open
  - Standard 4 Position Power Tool Holder Included
- Sale \$2,187.44 **Tool Club \$1,749.95**

- EXT-EX4106TCBKBL Black w/ Blue Drawer Pulls
- EXT-EX4106TCBKRD Black w/ Red Drawer Pulls
- EXT-EX4106TCBLBK Blue w/ Black Drawer Pulls
- EXT-EX4106TCGRBK Green w/ Black Drawer Pulls
- EXT-EX4106TCMBBK Matte Black w/ Black Drawers
- EXT-EX4106TCORBK Orange w/ Black Drawer Pulls
- EXT-EX4106TCRDBK Red w/ Black Drawer Pulls

**ALL EXTREME BOXES ARE AVAILABLE!**

**TOOL BOXES**

## HOISTS

**AFF4008**  
1-1/2 Ton Lever Hoist  
5' chain lift.  
Sale \$282.81  
**Tool Club \$226.<sup>95</sup>**



**AFF4003**  
3 Ton Chain Hoist  
10' lift.  
Sale \$327.44  
**Tool Club \$261.<sup>95</sup>**



**APP635**  
3 Ton Lever Hoist  
5' lift.  
Sale \$474.94  
**Tool Club \$379.<sup>95</sup>**



**APP450**  
5 Ton Chain Hoist  
10' lift.  
Sale \$624.94  
**Tool Club \$499.<sup>95</sup>**

**APP660**  
6 Ton Lever Hoist  
5' lift.  
Sale \$749.94  
**Tool Club \$599.<sup>95</sup>**



## ENGINE TILTERS

**AFF582**  
Engine Tilter  
Sale \$124.94  
**Tool Club \$99.<sup>95</sup>**



**APPP7134**  
Engine Lift Sling  
600 lb capacity.  
Sale \$33.13  
**Tool Club \$26.<sup>50</sup>**



**WILW41034**  
Engine Lift Plate  
Sale \$18.44  
**Tool Club \$14.<sup>75</sup>**

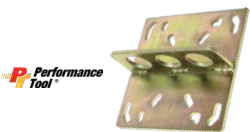

**OM92100**  
Wheel Arms (Pair)  
Includes 2 wheel arms and 2 magnetic trays. Efficiently hold tires on a vehicle lift arm. Adjusts horizontally and vertically. 100 lb capacity. Attaches to any lift!  
Sale \$174.94 **Tool Club \$139.<sup>95</sup>**



## ENGINE CRANES

**WILW41029**  
2 Ton Folding Engine Crane  
Adjustable boom w/ chain & hook. Legs fold for easy storage.  
Sale \$612.44  
**Tool Club \$489.<sup>95</sup>**



**THA67020**  
2 Ton Folding Engine Crane  
Adjustable boom w/ chain & hook. Legs fold for easy storage.  
Sale \$749.94  
**Tool Club \$599.<sup>95</sup>**



**AFF3582**  
2 Ton Folding Engine Crane  
Folds up for easy storage. Includes heavy duty 8 ton ram.  
Sale \$849.94  
**Tool Club \$679.<sup>95</sup>**



**HW93809USA**  
2 Ton Folding Engine Crane  
130" Extending height. 50" Reach. Swivel handle hook. Adjustable legs that can be folded up.  
Sale \$7,243.75  
**Tool Club \$5,795.<sup>00</sup>**



## ENGINE STANDS

**WILW41031**  
1250 lb. Capacity Engine Stand w/ Tray  
Head rotates 360° and locks in 6 positions. Securely holds most foreign and domestic engine blocks.  
Sale \$224.94 **Tool Club \$179.<sup>95</sup>**



**SUN8400**  
1 Ton Capacity Engine Stand  
Thick, reinforced mounting plate. 8 Locking angles.  
Sale \$466.88  
**Tool Club \$373.<sup>50</sup>**



**THA67106**  
1,000 lb. Capacity Engine Stand  
Head rotates 360° and locks in 8 positions. Securely holds most foreign and domestic engine blocks.  
Sale \$199.94  
**Tool Club \$159.<sup>95</sup>**



## AIR/HYDRAULIC JACKS

**AFF5520B**  
20 Ton  
Range: 10-1/2" to 20"  
Sale \$349.94  
**Tool Club \$279.<sup>95</sup>**



**AFF5621SD**  
20 Ton Low Profile Super Duty  
Range: 7" to 12-3/4". 1-1/8" thick base.  
Sale \$487.44  
**Tool Club \$389.<sup>95</sup>**



**AFF5620SD**  
20 Ton Super Duty  
Range: 10-3/8" to 20-5/8". 1-1/8" thick base.  
Sale \$499.94  
**Tool Club \$399.<sup>95</sup>**



**AFF5630SD**  
30 Ton Super Duty  
Range: 11" - 20.6" 1-1/8" thick base.  
Sale \$624.94  
**Tool Club \$499.<sup>95</sup>**



## BOTTLE JACKS



### 1 YEAR WARRANTY FOR ALL BOTTLE JACKS

Part #	Capacity (TONS)	Range	Sale	Club
AFF3502	2	6.25" - 12.75"	\$40.63	<b>\$32.<sup>50</sup></b>
AFF3504	4	6.5" - 13.25"	\$50.63	<b>\$40.<sup>50</sup></b>
AFF3506	6	8" - 16"	\$58.69	<b>\$46.<sup>95</sup></b>
AFF3508	8	7.75" - 15.5"	\$76.88	<b>\$61.<sup>50</sup></b>
AFF3512	12	8.5" - 17"	\$99.94	<b>\$79.<sup>95</sup></b>
AFF3514	12 Low	7" - 13"	\$99.94	<b>\$79.<sup>95</sup></b>
AFF3520	20	9.4" - 18.25"	\$174.94	<b>\$139.<sup>95</sup></b>
AFF3522	20 Low	7.75" - 14.25"	\$174.94	<b>\$139.<sup>95</sup></b>
AFF3530	30	11" - 18.6"	\$374.94	<b>\$299.<sup>95</sup></b>
AFF3550	50	12" - 19"	\$593.75	<b>\$475.<sup>00</sup></b>

## REPLACEMENT RAMS

**AFFLRC3B** 3 Ton  
Sale \$199.94  
**Tool Club \$159.<sup>95</sup>**

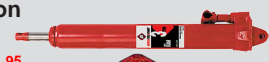

**AFFLRC8B** 8 Ton  
Sale \$249.94  
**Tool Club \$199.<sup>95</sup>**



## ENGINE HANGERS

**AFF583**  
Engine Hanger  
Adjusts: 26" to 49"  
1,250 lb capacity  
Sale \$249.94  
**Tool Club \$199.<sup>95</sup>**



**OM44700**  
Engine Hanger  
For supporting a transverse engine during service.  
Sale \$156.19 **Tool Club \$124.<sup>95</sup>**





# UNDERHOISTS

**SUN6809A**  
Underhoist Stand  
3/4 ton capacity  
53" - 79"  
Sale \$162.44  
**Tool Club \$129.95**

**SUN6810A**  
Underhoist Stand  
with Pedal  
3/4 ton capacity  
53-3/4" - 78-7/8"  
Sale \$181.25  
**Tool Club \$145.00**

**THA63007**  
Auxiliary Stand  
3/4 ton capacity. 53.5" - 80"  
Sale \$174.94  
**Tool Club \$139.95**

**THA63008**  
Auxiliary Stand with Pedal  
3/4 ton capacity. 53.5" - 80"  
Sale \$187.44  
**Tool Club \$149.95**



**PROT2501**  
700lb Economy  
Transmission Jack  
Range: 57-1/4" - 76-3/8"  
Saddle Area:  
9-7/8" x 9-7/8" to  
18-7/8" x 18-7/8"  
Sale \$524.94  
**Tool Club \$419.95**

**SUN7700C**  
700lb H.D.  
Pedestal Telescopic  
Transmission Jack  
Range: 50.8" - 70.5"  
Manual piston pump.  
90 Day Warranty  
Sale \$412.44  
**Tool Club \$329.95**

**SUN7793B**  
1,000lb.  
Transmission Jack  
Range 36-1/2" to 79-1/2"  
Sale \$1,187.44  
**Tool Club \$949.95**

**THA65100**  
1/2 Ton Transmission Jack  
2 Stage telescopic design.  
Saddle adjusts to multiple  
angles. Min/Max Height:  
33.4375" / 70.625"  
Sale \$1,124.94  
**Tool Club \$899.95**

**OM42001**  
2,000lb.  
Telescopic  
Transmission Jack  
Range: 48-1/2" to 77-3/8".  
With Air Motor.  
Sale \$2,999.94  
**Tool Club \$2,399.95**

**HEAVY DUTY**

**AFF3102**  
2,000lb. Manual  
Telescopic  
Transmission Jack  
Range: 37" to 76"  
Double pump hydraulic  
lift system.  
Sale \$1,349.94  
**Tool Club \$1,079.95**



**HEIN-WERNER  
AUTOMOTIVE**



**HW93720USA**  
1,000lb.  
Air/Hydraulic Telescopic  
Transmission Jack  
Range 34" to 72".  
Combines air  
(first stage only)  
and hydraulic power.  
Sale \$3,749.94  
**Tool Club \$2,999.95**



**PROT1452**  
1,100lb Low Profile  
Transmission Jack  
Range: 9" to 24-3/4"  
Sale \$499.94  
**Tool Club \$399.95**



**AFF**  
**FREE SHIPPING!**

**AFF3180**  
4,400 lb. Jack  
Only transmission jack available with a  
4,400 lb. capacity. Range: 8-1/2" to 34".  
Sale \$1,999.94 **Tool Club \$1,599.95**



**OTC5019A**  
1 Ton Transmission Jack  
Range: 8-1/4" - 36-1/2".  
Sale \$3,624.94 **Tool Club \$2,899.95**

**OM46500**  
DPF/Step Housing Handler  
Allows single technician to remove and install  
DPF/Step Housing. Pump handle allows user to  
operate with foot or hand. Adjustable saddle width  
accommodates all sizes of DPF/Step Housings.  
Sale \$1,374.94 **Tool Club \$1,099.95**



**AFF3182**  
2,500lb  
Power Train Lift / Table  
Can be used as a work  
table or lift. 4 safety  
latches. Air assist foot  
pump with air extension.  
Height: 33" - 77".  
Sale \$6,619.94  
**Tool Club \$5,295.95**



**OTC5295**  
Powertrain Lift  
Lifting Height  
Range: 21.5" - 70.0".  
Capacity: 1,760 lbs.  
Sliding split table top design  
allows for separation of the engine/  
transmission assembly or hybrid  
engine/generator  
module. Designed  
to handle removal &  
installation of electric  
vehicle batteries, fuel  
tanks, suspension  
systems & future  
powertrains.  
Tilting table provides alignment correction.  
**CALL FOR BEST PRICE**



**HEAVY DUTY**

**HEIN-WERNER  
AUTOMOTIVE**



**HW93718**  
2,000 lb Floor  
Transmission Jack  
Wishbone design. Range: 10-1/4" - 44-3/4".  
Sale \$4,249.94 **Tool Club \$3,399.95**



**HEIN-WERNER  
AUTOMOTIVE**

**HW93503USA**  
3 Ton Jack Stands  
Range: 11-1/2" to 17".  
Sale \$149.94



**HW93506USA**  
6 Ton Jack Stands  
Range: 15-1/2" to 24-3/4".  
Sale \$274.94



**HW93511**  
10 Ton High Reach Jack Stands  
Heavy Duty pin style adjustment.  
Range: 30" to 52".  
Sale \$1,224.94



**HW93512**  
10 Ton Heavy Duty Jack Stands  
Heavy Duty pin style adjustment.  
Range: 19.5" to 31.5".  
Sale \$974.94



**OTCS03**  
3 Ton Ratcheting Jack Stands  
Range: 12" - 17-11/16".  
Self-locking ratchet handle.  
V-notch style saddle.  
Sale \$91.88



**OTCS06**  
6 Ton Ratcheting Jack Stands  
Range: 15-5/8" - 23-11/16".  
Self-locking ratchet handle.  
V-Notch style saddle.  
Sale \$162.44



**OMEGALIFT**

**OM32038**  
3 Ton Double Locking Ratchet Style Jack Stands  
Range: 11-1/2" - 17".  
Can easily position or transport stands when pin lock is engaged.  
Sale \$99.94



**OM32068**  
6 Ton Double Locking Ratchet Style Jack Stands  
Range: 16" - 23-1/2".  
Can easily position or transport stands when pin lock is engaged.  
Sale \$168.69



**OM32225B**  
22 Ton Heavy Duty Truck Stands  
Welded steel construction prevents distortion or twisting.  
Range: 12-1/4" to 19-7/8".  
Sale \$424.94



**AFF3303**  
3 Ton Jack Stands  
Range: 12" to 18"  
Sale \$82.44



**AFF3306**  
6 Ton Jack Stands  
Range: 15-3/4" to 24-3/4"  
Sale \$149.94



**AFF3312B**  
12 Ton Jack Stands  
Range: 19-1/2" to 28".  
13" x 11-5/8" base.  
Notched saddles.  
Sale \$299.94



**AFF6422**  
22 Ton Pin Style Jack Stand Set  
Range: 11.8" - 19.7"  
10" x 10" base.  
V-shaped saddles.  
Sale \$331.19



**TRUCK STANDS**

15,000 LB. CAPACITY.  
Rubber pad protects the vehicle from damage. Spring loaded casters for ease of positioning.



**AFF3344SD**  
15,000lb. Truck Stand - Short  
Range from 36" to 54".  
17-1" height adjustments.  
Sale \$1,249.94



**AFF3309B**  
HD 10 Ton Jack Stand  
Range: 18-1/2" to 30"  
Pin-type post adjusts to 7 positions. Carry handle.  
Sale \$449.94



**AFF3310B**  
HD 10 Ton High Jack Stand  
Range: 28" to 47"  
3-1/8" x 5-7/8" support saddle & 16" x 16" base.  
Ten height positions.  
Sale \$612.44



**OTC1779B**  
12 Ton High Jack Stand  
Spun steel base won't dig or sink into asphalt or sand.  
Range: 33-3/4" - 44-1/4"  
Sale \$499.94



## AMERICAN MADE JACKS

- Wider For More Stability Under A Load
- Large Font Wheels And Rear Casters
- Cast Iron Pump Base For Strength & Durability
- Sealed Hydraulic Pump
- In-Line Pump Assembly For Long Life



HEIN-WERNER  
AUTOMOTIVE

### HW93642USA 2 Ton Jack

Most popular jack available.  
Range: 4-1/4" - 20"  
Sale \$487.44  
**Tool Club \$389.95**



### HW93652USA 3 Ton Jack

Most rugged jack available.  
Range: 4" - 23".  
Sale \$724.94  
**Tool Club \$579.95**



## FLOOR JACKS

### AFF350SS

#### 3.5 Ton Double Pump

Double pump for added speed.  
Features a removable rubber pad plus a padded handle.  
No more scratches.  
Range: 4" - 19.5".  
Sale \$524.94  
**Tool Club \$419.95**



### AFF400SS

#### 4 Ton HD Floor Jack

Heavy Duty Steel Construction. Twin hydraulic system for maximum speed.  
Pinned and padded saddle.  
Range: 4.3" - 20.5".  
Sale \$537.44  
**Tool Club \$429.95**



VIKING

### AFF53350JPK 3.5 Ton Jack & 6 Ton Jack Stand Combo

Jack range: 5-1/8" - 21".  
Doublepump hydraulic system.  
Jack Stands: Max Height: 34-3/4".  
Sale \$512.44 **Tool Club \$409.95**



## LOW-PROFILE JACKS

### WILW1642

2 Ton Low Profile Jack  
Range: 2-3/4" - 20"  
Sale \$274.94  
**Tool Club \$219.95**



### AFF200T

2 Ton H.D. Low Profile Service Jack  
Range: 2.75" - 20"  
Sale \$499.94  
**Tool Club \$399.95**



### WILW1645

3.5 Ton Low Profile Jack  
Range: 3-1/2" - 20-1/2"  
Sale \$374.94  
**Tool Club \$299.95**



### THA33502F

3.5 Ton "Quick-Start" Service Jack  
Range: 3-3/4" - 21-3/4"  
"Quick-Start" technology for One-Pump-To-Contact effortless performance.  
Padded saddle for vehicle protection. Heavy Duty U-Joint mechanism. Heavy Duty & reinforced chassis & lift arm.  
Sale \$374.94 **Tool Club \$299.95**



## ALUMINUM JACKS

### THA31501

1.5 Ton Aluminum Transmission Jack  
Range: 3.15" - 14".  
Double pump design.  
Hydraulic oil by-pass system.  
Sale \$231.19  
**Tool Club \$184.95**



### SUN66175FASJ

1.5 Ton Aluminum Service Jack  
Range: 3.5" - 16.5".  
Compact folding design.  
Rapid rise technology reaches max height in 5 pumps.  
Sale \$377.19 **Tool Club \$301.75**



### AFF208

2 Ton Aluminum Service Jack  
Range: 3-1/2" - 18-1/2".  
Double pump design.  
2 side handles.  
Heavy gauge steel. Flanged side plates for strength.  
Padded saddle.  
Sale \$537.44  
**Tool Club \$429.95**



### AFF210

3 Ton Aluminum Service Jack  
Range: 3.75" - 19.3".  
Double pump design.  
Sale \$624.94 **Tool Club \$499.95**



## BOTTLE JACKS



Part #	Capacity (TONS)	Range	Sale	Club
WILW1621	2	7 1/8" - 13 1/2"	\$28.13	<b>\$22.50</b>
WILW1625	6	8 1/2" - 16 1/4"	\$45.63	<b>\$36.50</b>
WILW1628	8	9" - 18"	\$61.88	<b>\$49.50</b>
WILW1632	12	9 1/4" - 18 1/2"	\$72.81	<b>\$58.25</b>
WILW1633	20	9 1/2" - 17 3/4"	\$109.19	<b>\$87.35</b>
WILW1644	20 Low	7 1/2" - 13 1/8"	\$99.94	<b>\$79.95</b>

### Pro-Lift

### PROT3310 Wheel Dolly (PAIR)

1,000lb Capacity (each). Fits 12" wide tires  
Sale \$124.94 **Tool Club \$99.95**



### WILW54013 Wheel Dolly (PAIR)

1,000 lb. capacity (each). Fits 14" wide tires.  
Sale \$124.06 **Tool Club \$99.25**



## GOJAK™ THE FASTER CASTER SYSTEM

### GOJACK7016

1,750 lb. SUV GOJAK (EACH)  
Max tire width: 16". For light duty Class 1 & 2 trucks and SUVs.  
1,750 lb capacity per wheel.  
Sale \$499.94  
**Tool Club \$399.95**



### GOJACK6313

1,574 lb. GOJAK (EACH)  
Fits tires up to 13" wide. With a ratcheting mechanism.  
Sale \$424.94  
**Tool Club \$339.95**



### GOJACK567R

Go-Jak™ Storage Rack Cart  
Fits all Go-Jak™ models.  
Loads & unloads in seconds.  
Go-Jaks not included.  
Sale \$162.44  
**Tool Club \$129.95**



## FLOOR JACKS



ALL MADE IN THE USA

HW93657USA

**4 Ton HD Long Chassis Manual Service Jack**

Handle adjusts to three pumping positions. Height Range: 5" - 25-3/4". Sale \$2,999.94

**Tool Club \$2,399.95**



HW93662USA

**10 Ton Long Chassis Air/Manual Service Jack**

Uses standard shop air 110-175 PSI. Sale \$5,499.94

**Tool Club \$4,399.95**



**FREE SHIPPING!**

AFF3120

**5 Ton Long Chassis**

Extra long chassis. Range: 6" to 22.5". Foot operated pump. Handle locks in 3 different positions. Sale \$1,374.94

**Tool Club \$1,099.95**



AFF3135

**10 Ton Air/Hydraulic Jack**

Use by hand or with shop air. Range: 7" to 23" Sale \$2,124.94

**Tool Club \$1,699.95**

**FREE SHIPPING!**



THA62100

**10 Ton Long Chassis Manual Service Jack**

Range: 6-1/4" - 27". Welded hydraulic assembly to assure strength & eliminate leaks. Built-in bypass system prevents the ram from over-extending. T-Handle with 3 locking positions (90°, 45° & 0°). Sale \$1,687.44

**Tool Club \$1,349.95**



AFF3225

**20 Ton Air/Hydraulic Long Chassis Jack**

Extra long chassis. Range: 7.5" - 26.375". 3 lever locking positions. Air motor designed for use with compressed air between 90-120PSI. Sale \$4,249.94

**Tool Club \$3,399.95**



## AIR - OPERATED JACKS

OTCUA22

**22 Ton Under Axle Jack**

90 - 145 PSI. Reach: 69.87". Lifting Range: 8.27" - 20-2/3". Includes 3 attachments for adjusting height. Sale \$1,087.44

**Tool Club \$869.95**

OTC



AFF565F

**22 Ton Air Assist Truck Axle Jack**

90 - 180 PSI. Lifting Range: 8-1/4" - 21-1/2" Includes 3 attachments for adjusting height. Sale \$874.94

**Tool Club \$699.95**

AFF



AFF56220A

**22 Ton Air Assist Truck Axle Jack**

Low height: 10-1/2". Max Height: 17-3/4". 61" reach. Narrow chassis design fits easily between tandem wheels. Sale \$812.44

**Tool Club \$649.95**

VIKING



THA422001Q

**20 Ton Air Operated Axle Jack**

Low height 9". Max height 18". Built-in bypass device to protect hydraulic system from over pumping damage. Built-in muffler to promote quiet operation. High speed turbo motor for efficient effortless operation. Sale \$662.44

**Tool Club \$529.95**

Safeguard



## 2 / 3 STAGE AIR / HYDRAULIC JACKS

EXTRA LONG HANDLES  
INCLUDES HEIGHT ADAPTERS  
SINGLE PIECE BASE

**FREE SHIPPING!**



Part #	Capacity (TONS)	Range	Sale	Club
AFF545SD	30 / 15	5.92" - 11.5"	\$1,994.94	<b>\$1,595.95</b>
AFF546SD	25 / 10	7.28" - 14.84"	\$2,587.44	<b>\$2,069.95</b>
AFF547SD	50 / 25	8.46" - 23.31"	\$3,312.50	<b>\$2,650.00</b>
AFF548SD	60/40/20	6.89" - 15.91"	\$3,874.94	<b>\$3,099.95</b>
AFF549SD	80 / 50	9.06" - 17.32"	\$4,118.75	<b>\$3,295.00</b>

## TRUCK RAMPS

THA69201

**20 Ton Wide Truck Ramps**

Dimensions: 45-3/8" x 18-1/4" x 9-1/2". Large wheel designs for extra durability. Non-skid rubber matting. Long retractable T-handle. Designed specifically for heavy duty tasks. Wide design. Sale \$1,124.94 **Tool Club \$899.95**



## END LIFTS

AFF3598

**10 Ton End Lift**  
10 ton capacity for lifting large trucks or trailers. Range: 17-1/2" to 50" Sale \$4,749.94

**Tool Club \$3,799.95**

**FREE SHIPPING!**

AFF



HW93690USA

**10 Ton Air Operated End Lift**

Lifts 10 tons at 200 psi. 2-1/2" pneumatic rear tires and (2) 6" casters for easier transport. Sale \$6,624.94

**Tool Club \$5,299.95**

**FREE SHIPPING!**

HEIN-WERNER AUTOMOTIVE

MADE IN USA



HEIN-WERNER AUTOMOTIVE

MADE IN USA

HW93735A

**25 Ton Axle Jack with 3" Extension**

Range: 8" - 18" Rapid two-speed air hydraulic action. Large 8" rubber wheels. Pressure relief valve. Sale \$2,937.44

**Tool Club \$2,349.95**



PLATINUM SERIES

UP TO 5 YEAR WARRANTY

BHP225

**25 Ton Platinum Series Air / Hydraulic Axle Jack**

Range: 9.15" - 22" Chrome plated ram. Includes: 1", 2.5", 6" & 7" extensions. 5 year warranty. Sale \$1,062.49

**Tool Club \$849.99**



Safeguard

**NEW!**

SOLD IN PAIRS

# CREEPERS



LIS94102 - Blue



LIS93102 - Yellow



LIS92102 - Red



LIS93202 - Orange



LIS99102 - Green



LIS97102 - Black



## PLASTIC CREEPERS

Sale \$109.38 **Tool Club \$87.50**

Strong low profile creepers feature 6 wheels and a comfortable curved shape. 300lb capacity.



**AFF57100**  
**Viking HDPE Mechanic Creeper**  
Six (6) rollerskate-style wheels.  
42" Super Low Profile. 440lb capacity.  
Sale \$148.69 **Tool Club \$118.95**

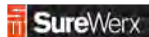

**OM91400**  
**The Spider Lowrider**  
Low profile creeper. 400 lb. capacity. 2" minimum height clearance. 6 HD wheels. Thick padded cushions for added comfort. Thick steel frame.  
Sale \$187.44 **Tool Club \$149.95**



**OMEGALIFT**  
**OMC6040**  
**40" Plastic Creeper**  
Ergonomic lightweight HDPE body. 350lb capacity. 6 oil resistant 3" casters. Padded head rest. Easy carry handle.  
Sale \$112.44 **Tool Club \$89.95**

**AFF3905**  
**37" Red Padded Mechanic's Creeper**  
250lb capacity. Full-length, padded, oil resistant vinyl panel. 6 2-1/2" swivel casters.  
Sale \$74.94 **Tool Club \$59.95**



**WILW85006**  
**Plastic Creeper**  
Comfortable curved shape.  
Sale \$71.19  
**Tool Club \$56.95**



**WILW85038**  
**High Top Adjustable Creeper**  
Adjustable Creeper height 45 to 66". Maximum 400lb weight capacity. Four swivel casters, two locking. 18" x 12" padded deck. Folds up for easy & compact storage. Heavy Duty steel construction.  
Sale \$324.94  
**Tool Club \$259.95**



**WILW85005**  
**Adjustable Headrest Padded Creeper**  
With strong metal frame.  
Sale \$74.94 **Tool Club \$59.95**



**WC-80PRO**  
**Pro Cool Climate Control**  
Ideal for mechanical garages/home garages, small warehouses, manufacturing facilities & more! 4,700 CFM. 26.5 Gallon water capacity. Effective cooling range: 1,350 sq.ft. Digital control panel with remote. 85% evaporation efficiency. 3 speed adjustable fan. Weighs 83 lbs.  
Sale \$1,312.44  
**Tool Club \$1,049.95**



## PORTACOOL

WHEN COMFORT COUNTS™

**PORPACJS2501A1**  
**Jetstream 250 Portable Evaporative Cooler**  
Kool Comfort™ evaporative media. Low-water shutoff and cord wrap included. 8,500 CFM. 24 mph velocity. 55G water reservoir. Weighs 191lbs. Dimensions: 70"H x 52"W x 30"D.  
**CALL FOR BEST PRICE**



**SUN8514**  
**Padded Tractor Seat**  
Very comfortable. Adjusts 18" to 22". Includes 17" tool tray.  
Sale \$174.94  
**Tool Club \$139.95**



**SUN8516**  
**Adjustable Shop Seat**  
Cushioned seat. Perfect for shop or garage use.  
Sale \$162.44  
**Tool Club \$129.95**



**WILW85011**  
**Pneumatic Swivel Bar Stool**  
Adjusts from 26" - 32". 360° swivel. 330 lb weight capacity.  
Sale \$87.44  
**Tool Club \$69.95**



**WILW85007**  
**Creeper Seat**  
Includes tray.  
Sale \$49.94  
**Tool Club \$39.95**



**WILW85024**  
**2 Drawer Rolling Mechanics Seat**  
Flip top tool chest w/ 2 sliding drawers. 350 lb capacity. Dual side trays. 2-1/2 inch full bearing casters.  
Sale \$124.94  
**Tool Club \$99.95**



**LIS95002**  
**Folding Pad**  
Sale \$49.94  
**Tool Club \$39.95**



18" x 48"

**EPPFENDERBLACK**  
**Fender Cover**  
Sale \$16.19  
**Tool Club \$12.95**



## MANUAL SHOP PRESSES

**AFF820A**

### 20 Ton Manual Shop Press

- For light auto & industrial use.
  - HD return springs for fast ram retraction.
  - Two press plates & bearing punch.
  - 61" tall with a 27" base width.
  - Eight level bed adjustment.
- Sale \$1,374.94 **Tool Club \$1,099.95**



**AFF832A**

### 30 Ton Manual Shop Press

- For auto & light industrial use.
  - 8 bed adjustments.
  - 30-ton bottle jack w/overload protection.
  - HD return springs.
  - 66" tall with 30" base width.
- Sale \$1,599.94 **Tool Club \$1,279.95**

**WILW41062**

### 12 Ton Commercial Shop Press

- 7 Adjustable Height Locations.
  - 12 Ton Capacity.
  - Remote pressure cylinder with relief valve.
  - Liquid-Filled 4" pressure indicator gauge.
  - 65" overall height.
  - 152lbs overall weight
- Sale \$549.94 **Tool Club \$439.95**



## HEAVY DUTY SHOP PRESSES

### FREE SHIPPING ON ALL SUPER DUTY PRESSES

Feature welded frame & heavier gauge steel for heavy duty truck applications, spring shops, industrial, or those in need of a "step up" from a regular duty press.

**AFF850ASD**

### 20 Ton Capacity

Sale \$2,243.75  
**Tool Club \$1,795.00**



**AFF852ASD**

### 30 Ton Capacity

Sale \$2,999.94  
**Tool Club \$2,399.95**



INCLUDES  
ACCESSORY KIT

**AFF854ASD**

### 50 Ton Capacity

Sale \$4,999.94  
**Tool Club \$3,999.95**

**AFF856ASD**

### 75 Ton Capacity

Sale \$6,868.75  
**Tool Club \$5,495.00**

**AFF859ASD**

### 100 Ton Capacity

Sale \$11,249.94  
**Tool Club \$8,999.95**



**SUN57KIT6**

### 6pc Press Accessory Kit

For presses up to 50 ton.  
1/2", 1" & 2" punches.  
Bearing shield. Two steel plates.  
Sale \$182.19 **Tool Club \$145.75**



**SUNEX**  
TOOLS

**SUN57KIT8**

### 8pc Press Punch Kit

For presses up to 50 ton.  
1/2", 3/4", 1", 1-1/2", & 2" punches.  
Bearing shield. Two steel plates.  
Sale \$286.56 **Tool Club \$229.25**



## WORK BENCHES

**TIT21009**

### Professional Workbench

Durable powder-coated finish.  
Full bottom shelf.  
Weight capacity: 1,200 lbs.  
Top panel: 13 gauge steel.  
Bottom shelf: 13 gauge steel.  
Steel support: 12 gauge steel.  
Sale \$499.94  
**Tool Club \$399.95**



**TIT21006**

### 60" Work Bench

60"W x 31"D x 34"H  
Full bottom shelf.  
1,200 lb weight capacity.  
Sale \$499.94  
**Tool Club \$399.95**



**TIT21005**

### Work Bench Wheel Set

Sale \$66.19 **Tool Club \$52.95**



**SUN8019**

### Deluxe Work Table

Easy to maneuver 2" casters.  
1" deep drawer for convenient storage. On-board screwdriver & pry bar holder. Air Tool hose cut-outs. Durable textured rubber mat for non-skid surface. Adjustable table height from 34" - 47.75".  
Sale \$214.06 **Tool Club \$171.25**



**SUN8034**

### Standard Plastic Utility Cart

500 lbs weight rating. 4 storage bins.  
Dimensions: 32.28 x 18.5 x 8.66 in  
Sale \$262.44 **Tool Club \$209.95**

**SUN8036**

### Large Plastic Utility Cart

500 lbs weight rating. 5 storage bins.  
Dimensions: 32.28 x 18.5 x 8.66 in  
Sale \$349.94 **Tool Club \$279.95**



**AST8330**

### H.D. Plastic 2 Shelf Utility Cart

3-1/2" deep trays & can hold up to 300 lbs.  
Size: 16"(W) x 30"(L) x 31"(H).  
Made of Polypropylene.  
Sale \$124.94  
**Tool Club \$99.95**

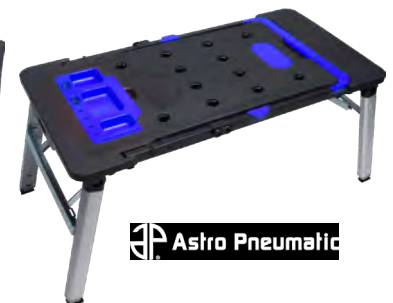

**AST55670**

### 7-in-1 Workbench

Includes: Workbench, saw horse, scaffold, platform, car creeper, dolly and hand truck. 550lb max capacity in scaffold & platform mode. 330lb max capacity in other modes. Includes integrated power strip. 43"x21.75" work surface. 20.5" to 30.75" working height.  
Sale \$218.69 **Tool Club \$174.95**





**WLT28806**  
**5-1/2" Tradesman Vise**  
 60,000 PSI ductile iron casting. Fully enclosed spindle & nut. Large anvil. Replaceable jaws. 360° swivel base w/ double lockdowns. Jaw Width: 5.5" Jaw Opening: 5" Sale \$949.94  
**Tool Club \$759.95**



**WLT28807**  
**6-1/2" Vise w/ Reversible Top Jaws**  
 Jaw Width: 6-1/2" Pipe Capacity: 3/8" to 3-1/2" Throat Depth: 4-3/4" Sale \$1,062.44  
**Tool Club \$849.95**



**WLT28828**  
**8" Trade Vise**  
 60,000 PSI. Jaw Width: 8" Jaw Opening: 7" Throat Depth: 4-3/4" Pipe Capacity: 1/8" to 3-1/2" Sale \$3,243.75  
**Tool Club \$2,595.00**



**TIT22016**  
**6" Bench Vise**  
 Forged steel beam. Swivel base w/ position lock. Sale \$199.94  
**Tool Club \$159.95**



**TITAN**

**TIT22059**  
**10" Swivel Base Vise**  
 Replaceable hardened steel jaws. Precision cast iron beam. Sale \$562.44  
**Tool Club \$449.95**



**WLT11128BH**  
**6-1/2" High-Viz Safety Vise w/ FREE Hammer**  
 6.5" Jaw Width. Large anvil work surface. Special edition high-viz paint color. Includes FREE WLT20412 - 12" 4 lb head BASH sledge hammer. Sale \$312.44  
**Tool Club \$249.95**



**TRAILER HITCH MOUNT**  
**WLT10025BH**  
**5" ATV All Terrain Vise w/ 2.5lb Sledge Hammer & Mounting Bracket**  
 Can be mounted on a bench or standard 2" trailer hitch. Lightweight with carrying handle. Water resistant for all weather. Large striking surface. Clamps objects up to 5". Sale \$312.44  
**Tool Club \$249.95**



**AFF3941**  
**5" Flat & Pipe Jaws Swivel Base Vise**  
 Swivel Base. Serrated flat jaws. 5" jaw capacity. 3" throat depth. Weighs 27.5lbs. Features an anvil. Sale \$124.94  
**Tool Club \$99.95**



**NEW!**

**JET577172**  
**HD Bench Grinder Pedestal**  
 31" high. Pre-drilled holes for floor mounting. Sale \$249.94  
**Tool Club \$199.95**



**WLT11114**  
**400CS 4pc Hi-Viz C-Clamp Kit**  
 Sizes: 2", 4", 6" & 8". Clamps down with up to 6,900lbs of force! Sale \$162.44  
**Tool Club \$129.95**

**NEW!**



**BENCH GRINDERS**

**SUNEX TOOLS**

- H.D. Cast Iron Base
- Mounting holes
- 36 & 60 grit wheels
- **40 watt flexible work light**
- Includes eye shields & tool rests



Part #	Size	HP	RPM	Sale	Club
SUN5001A	6"	1/2	3,450	\$230.94	<b>\$184.75</b>
SUN5002A	8"	3/4	3,450	\$261.19	<b>\$208.95</b>

**WILW50003**  
**3" Portable Bench Grinder**  
 31" flexible shaft rotary tool w/ 1/8" Colette. Includes 3" x 3/4" - 80 grit grinder stone & fiber wheel w/ 10mm arbor. Sale \$78.13  
**Tool Club \$62.50**



**H.D. GRINDERS**

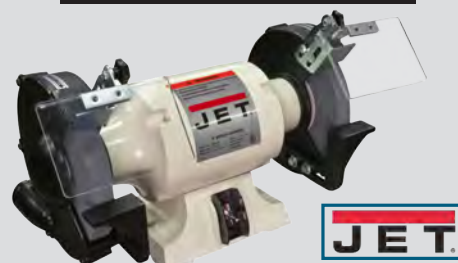

- Totally enclosed pre-lubricated ball bearings.
- Rubber mounts prevent movement.
- H.D. guarded toggle switch.
- Cast iron wheel guards and dust vents.
- Fine and coarse vitrified grinding wheels.

Part #	Size	HP	RPM	Sale	Club
JET577101	6"	1/2	3,450	\$368.69	<b>\$294.95</b>
JET577102	8"	1	3,450	\$487.44	<b>\$389.95</b>
JET577103	10"	1.5	1,725	\$874.94	<b>\$699.95</b>



**WIRE WHEELS**

Part #	Size	Arbor Hole	Sale	Club
SH14057	6"	1/2" to 5/8"	\$18.13	<b>\$14.50</b>
SH14058	6"	1/2"	\$25.31	<b>\$20.25</b>
SH14059	8"	5/8"	\$39.38	<b>\$31.50</b>

**GRINDING WHEELS**

**ALUMINUM OXIDE**

Part #	Size	Grit	Face Width	Sale	Club
SH12771	6"	36	3/4"	\$22.19	<b>\$17.75</b>
SH2017	6"	46	3/4"	\$21.69	<b>\$17.35</b>
SH12772	6"	60	3/4"	\$22.19	<b>\$17.75</b>
SH12773	6"	80	3/4"	\$22.19	<b>\$17.75</b>
SH12778	7"	60	1"	\$24.06	<b>\$19.25</b>
SH12780	8"	36	1"	\$35.00	<b>\$28.00</b>
SH12781	8"	60	1"	\$35.00	<b>\$28.00</b>

**SPARK-DUTY FORGED HI-VIS C-CLAMPS**

OSHA SAFETY COLOR FOR PHYSICAL HAZARDS

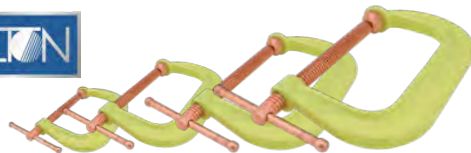

Drop forged, regular duty with extra deep throat. Copper plated spindle and Perma-pad® for resistance to welding spatter and corrosion, and are replaceable. Exceptional value high-visibility welding clamps. Lifetime Warranty.

Part #	Size	Sale	Club
WLT20483	4"	\$58.69	<b>\$46.95</b>
WLT20484	6"	\$89.94	<b>\$71.95</b>
WLT20485	8"	\$115.44	<b>\$92.35</b>
WLT20486	10"	\$162.44	<b>\$129.95</b>

**BASH SLEDGE**



Part #	Head	Length	Sale	Club
WLT20212	2.5lbs	12"	\$73.69	<b>\$58.95</b>
WLT20412	4lbs	12"	\$87.44	<b>\$69.95</b>
WLT20416	4lbs	16"	\$94.38	<b>\$75.50</b>
WLT20630	6lbs	30"	\$137.44	<b>\$109.95</b>
WLT20816	8lbs	16"	\$139.94	<b>\$111.95</b>
WLT20830	8lbs	30"	\$159.94	<b>\$127.95</b>
WLT20836	8lbs	36"	\$168.69	<b>\$134.95</b>
WLT21036	10lbs	36"	\$194.38	<b>\$155.50</b>
WLT22036	20lbs	36"	\$324.94	<b>\$259.95</b>

**BASH BRASS SLEDGE**



\*\*BRASS HEADS ARE NON-SPARKING\*\*

Part #	Head	Length	Sale	Club
WLT90212	2.5lbs	12"	\$143.44	<b>\$114.75</b>
WLT90412	4lbs	12"	\$187.44	<b>\$149.95</b>
WLT90416	4lbs	16"	\$208.69	<b>\$166.95</b>
WLT90616	6lb	16"	\$286.88	<b>\$229.50</b>

**BASH CROSS PEIN**



Part #	Head	Length	Sale	Club
WLT30216	2lbs	16"	\$70.94	<b>\$56.75</b>

**BASH DEAD BLOW**



Part #	Head	Length	Sale	Club
WLT55314	2.5lbs	12"	\$77.81	<b>\$62.25</b>
WLT55416	4lbs	16"	\$107.81	<b>\$86.25</b>
WLT55830	6lbs	30"	\$155.31	<b>\$124.25</b>

**BASH BALL PEIN**



Part #	Head	Length	Sale	Club
WLT32414	24oz	14"	\$62.44	<b>\$49.95</b>
WLT33214	32oz	14"	\$70.94	<b>\$56.75</b>
WLT34014	40oz	14"	\$79.06	<b>\$63.25</b>



**WLT11111**  
**3pc B.A.S.H. Mechanic's Hammer Set**  
 Includes: 4lb x 12" Sledge, 32oz x 14" Ball Pein, & 2lb x 16" Cross Pein.  
 Sale \$182.44 **Tool Club \$145.95**

**WLT11113**  
**3pc B.A.S.H. Dead Blow Hammer Kit**  
 Includes: 2lb x 14", 3lb x 14" & 4lb x 16".  
 Sale \$216.19 **Tool Club \$172.95**

**TIT63125** **TITAN**  
**5pc Hammer Set**  
 Ball Pein, Rubber Mallet, Sledge, & Cross Pein  
 Sale \$78.13  
**Tool Club \$62.50**

**WILM7134**  
**5pc Fiberglass Handle Ball Pein Set**  
 Sizes: 8, 12, 16, 24 & 32oz.  
 Sale \$73.44  
**Tool Club \$58.75**

**WLT31036**  
**B.A.S.H. 36" 10lb Spike Maul**  
 Hi-Vis, drop forged 46 HRC steel head endures the most demanding applications. Safety plate secures head to handle. Thick, tapered neck absorbs vibration. Vulcanized rubber handle for secure grip while striking.  
**NEW!**  
 Sale \$287.44 **Tool Club \$229.95**



**DEAD BLOW** **P Performance Tool**

HI-VISIBILITY COLOR

Part #	Size	Sale	Club
WILM7216	16oz.	\$14.38	<b>\$11.50</b>
WILM7224	24oz.	\$17.81	<b>\$14.25</b>
WILM7232	32oz.	\$20.94	<b>\$16.75</b>
WILM7248	48oz.	\$21.88	<b>\$17.50</b>
WILM7264	64oz.	\$24.69	<b>\$19.75</b>

**TIT63133**  
**3pc Dead Blow Set**  
 Sizes: 12oz, 1lb & 1-1/2lb. Shock absorbing steel shot filled canister for maximum force with reduced rebound  
 Sale \$45.63 **Tool Club \$36.50**

**GW GEARWRENCH**  
**KDT82303D** **NEW!**  
**5 Pc. Hammer and Mallet Set**  
 Sale \$137.44  
**Tool Club \$109.95**

**TIT85070**  
**5pc Hickory Wood Handle Hammer Set**  
 Includes 3lb sledge hammer, cross pein hammer, 32oz & 16oz ball pein hammers and 32oz rubber mallet. Wooden handles are lightweight & easy to replace if damaged, and are natural shock-absorbers.  
**NEW!**  
 Sale \$62.44 **Tool Club \$49.95**



**SLEDGE** **P Performance Tool**

ALL HAVE FIBERGLASS HANDLE

Part #	Size	Sale	Club
WILM7100	3 lb	\$18.69	<b>\$14.95</b>
WILM7101	4 lb	\$23.44	<b>\$18.75</b>
WILM7114	10 lb	\$46.88	<b>\$37.50</b>

**TIT63216**  
**2lb. Brass Hammer**  
 Sale \$53.69  
**Tool Club \$42.95**

**TIT63040**  
**3lb. Brass Hammer**  
 Sale \$82.81  
**Tool Club \$66.25**

**WILM7132**  
**32oz. Rubber Mallet**  
 Sale \$10.94  
**Tool Club \$8.75**

**WILM7019B**  
**8oz Stubby Claw Hammer**  
 Sale \$9.38  
**Tool Club \$7.50**

**AFF50500**  
**11lb H.D. Dead Blow Hammer w/ Steel Reinforced 11" Handle**  
**NEW!**  
 Sale \$20.31 **Tool Club \$16.25**

**WILM7040B**  
**2pc Hammer Set**  
 3lb Cross Pein & Sledge  
 Sale \$33.69 **Tool Club \$26.95**



**KDT82306  
27pc Punch & Chisel Set**

Includes:  
6 pin,  
6 starter,  
3 center,  
4 long taper,  
8 cold chisels  
& tool roll.  
Sale \$233.69  
**Tool Club \$186.<sup>95</sup>**



**MAY61050  
24pc Punch & Chisel Set**

Includes: 6 cold chisels, 1 cape chisel,  
1 half round chisel, 1 diamond point chisel,  
6 solid punches, 6 pin punches, 1 prick punch,  
2 center punches & tool roll.  
Sale \$185.63 **Tool Club \$148.<sup>50</sup>**



**MAY61019  
19pc Punch & Chisel Set**

Includes: 2 center, 6 pin punches, 6 solid  
punches, 5 cold chisels & tool roll.  
Sale \$137.44 **Tool Club \$109.<sup>95</sup>**

**KDT82305  
12pc Punch & Chisel Set**

Includes  
4 cold chisels,  
4 pin punches,  
4 taper  
punches.  
& tool roll.  
Sale \$86.56  
**Tool Club \$69.<sup>25</sup>**



**MAY62254  
12pc Pilot Punch**

Sizes: 1/16" - 1/2"  
Sale \$131.19  
**Tool Club \$104.<sup>95</sup>**



**MAY62250  
6pc Pilot Punch Set**

Sizes: 1/8", 5/32",  
3/16", 7/32",  
1/4", & 5/16".  
Sale \$66.25  
**Tool Club \$53.<sup>00</sup>**



**KDT82307  
4pc Long Taper  
Punch Set**

Sale \$49.38  
**Tool Club \$39.<sup>50</sup>**



**MAY61005  
6pc Punch & Chisel Set**

Includes: 1 center, 2 pin,  
1 solid, 2 cold chisels  
Sale \$48.75  
**Tool Club \$39.<sup>00</sup>**



**HD INDIVIDUAL CHISELS**

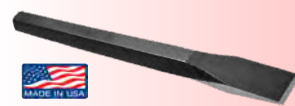

Part #	Size	Sale	Club
MAY10206	1/2 x 9"	\$11.88	<b>\$9.<sup>50</sup></b>
MAY10212	3/4 x 7"	\$12.19	<b>\$9.<sup>75</sup></b>
MAY10213	3/4 x 12"	\$16.88	<b>\$13.<sup>50</sup></b>
MAY10216	7/8 x 7.5"	\$16.88	<b>\$13.<sup>50</sup></b>
MAY10219	7/8 x 18"	\$30.63	<b>\$24.<sup>50</sup></b>
MAY10220	1 x 8"	\$21.88	<b>\$17.<sup>50</sup></b>

**KDT82309  
5pc Pin Punch Set**

Sale \$41.88  
**Tool Club \$33.<sup>50</sup>**



**MAY61044  
14pc Punch & Chisel Kit**

Includes: 5 cold chisels,  
2 solid punch, 5 pin  
punch, 1 punch aligner  
and 1 center punch  
Sale \$109.94  
**Tool Club \$87.<sup>95</sup>**

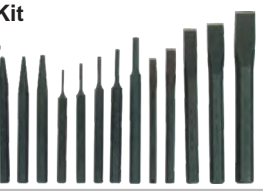

**KDT82304  
5pc Punch & Chisel Set**

Sale \$33.69  
**Tool Club \$26.<sup>95</sup>**



**BRASS PUNCHES**

**MAY61365  
3pc XL Brass Punch Set**

Includes: 3/4 x 12" drift punch,  
3/8" & 7/16" line up punches.  
Sale \$178.69  
**Tool Club \$142.<sup>95</sup>**

EXTRA  
LONG



**MAY67003  
5pc Brass  
Drift Punch Set**

Includes: 1/4 x 4,  
3/8 x 6, 1/2 x 7, 5/8 x 8  
3/4 x 8 Drift Punches  
Sale \$81.88  
**Tool Club \$65.<sup>50</sup>**



**KDT82308  
4pc Cold Chisel Set**

Sale \$49.38  
**Tool Club \$39.<sup>50</sup>**



**MAY62278  
4pc Brass Punch Set**

Includes: 1/4" solid, 3/8" drift,  
3/16" & 5/16" pin punches.  
Sale \$41.88  
**Tool Club \$33.<sup>50</sup>**



**MAY67001  
3pc Brass Scraper Set**

Includes: 3/8 x 5-1/2", 1/2 x  
6" and 5/8 x 6-1/2" Scrapers  
Sale \$57.81  
**Tool Club \$46.<sup>25</sup>**



**LIS30280  
Automatic Centerpunch**

Fires when downward pressure is applied.  
Sale \$22.44 **Tool Club \$17.<sup>95</sup>**



**MAY62277  
4pc Brass Punch Set**

Includes: 3/8" drift, 1/4" & 3/8" pin and  
1/4" brass solid punch.  
Sale \$49.38  
**Tool Club \$39.<sup>50</sup>**



**MAY67004  
3pc Brass Punch Set**

Includes: 1/4, 3/8  
and 1/2" Pin Punches  
Sale \$41.88  
**Tool Club \$33.<sup>50</sup>**



**MAY89021  
3pc Hammerless Set**

Includes Prick  
Punch/Center  
Punch combo, Pin  
Punch/Hammer Combo &  
Cold Chisel/Hammer  
Combo.  
Sale \$37.44  
**Tool Club \$29.<sup>95</sup>**



**MAY61360  
3pc Brass Drift Punch Set**

For non-sparking  
applications critical in  
hazardous conditions.  
Sale \$60.63  
**Tool Club \$48.<sup>50</sup>**



**MAY67012  
12pc Brass Punch & Scraper Set**

Includes: 2 scrapers,  
3 drift punches, 7 pin punches & tool roll.  
Sale \$116.56 **Tool Club \$93.<sup>25</sup>**





PRY BARS FEATURE A STEEL SHAFT THROUGH THE ENTIRE HANDLE



**MAY14068**  
**3pc Dominator® Long and Heavy Duty Pry Bar Set with Rack**  
 Sizes: 7/8" SQ x 44", 3/4" SQ x 48", 3/4" SQ x 58"  
 Sale \$343.69 **Tool Club \$274.95**

**MAY61366**  
**5pc Dominator Curved Pry Bar Set**  
 Strike-able end caps.  
 Sizes: 10", 12", 17", 25", & 31" long.  
 Sale \$149.38  
**Tool Club \$119.50**



**MAY61355**  
**3pc Curved Head Set**  
 Sizes: 7", 12" & 18" long.  
 Sale \$96.19 **Tool Club \$76.95**



**MAY14071BL**  
**3pc Blue Curved Pry Bar Set**  
 Sizes: 12", 17" & 25" long.  
 Sale \$104.38 **Tool Club \$83.50**



**MAY31091**  
**3pc Dominator® Economy Curved Pry Bar Set**  
 Sizes: 13", 17" & 24"  
 Sale \$56.88 **Tool Club \$45.50** **NEW!**



**MAY14074**  
**3pc HD Pry Bar Set**  
 Dominator pry bars. Includes: 36" & 24" Curved, & 18" Straight pry bars.  
 Sale \$173.13 **Tool Club \$138.50**



**MAY14065**  
**4pc Dominator® Curved Pry Bar Set**  
 Sizes: 8", 12", 25" & 36" long.  
 Sale \$174.38 **Tool Club \$139.50**



**MAY14064**  
**4pc Dominator® Straight Pry Bar Set**  
 Sizes: 8", 12", 25" & 36"  
 Sale \$169.94 **Tool Club \$135.95**



**MAY60150**  
**3pc Pro LadyFoot Bar Set**  
 Sizes: 1/2" x 12"; 5/8" x 16"; & 3/4" x 21  
 Sale \$116.88 **Tool Club \$93.50**



**KDT82301D**  
**3pc Indexing Pry Bar Set**  
 Sizes: 8", 10" & 16"  
 Sale \$174.94 **Tool Club \$139.95**



**KDT82233**  
**33" Indexing Pry Bar**  
 Head rotates 180° w/ 14 locking positions  
 Sale \$124.94 **Tool Club \$99.95**

**INDIVIDUAL DOMINATOR**



Part #	Length	Head	Sale	Club
MAY14116	31"	5/8" H.D. Curved	\$59.94	\$47.95
MAY14120	58"	5/8" H.D. Curved	\$137.44	\$109.95
MAY14107	36"	Straight	\$80.63	\$64.50
MAY14108	42"	Straight	\$86.19	\$68.95
MAY14117	36"	Curved	\$87.44	\$69.95
MAY14118	42"	Curved	\$88.13	\$70.50
MAY14119	48"	Curved	\$127.19	\$101.75
MAY14123	44"	Curved	\$162.44	\$129.95



**LANG853-5ST**  
**5pc Curved Pry Bar Set**  
 Sizes: 12", 17", 25", 31" & 36".  
 Tips are bent for ease of access.  
 Sale \$109.38 **Tool Club \$87.50**



**ANGLED BLADE**



Part #	Length	Sale	Club
SUN9812	12"	\$19.38	\$15.50
SUN9817	17"	\$22.19	\$17.75
SUN9825	25"	\$36.56	\$29.25
SUN9833	31"	\$41.88	\$33.50
SUN9837	37"	\$59.69	\$47.75
SUN9803	3pc 12", 17", 25"	\$70.63	\$56.50



**SUNEX TOOLS**

**KDT82821H**  
**6PC 4" Mini File Set**  
 Set includes Flat, Half Round, Round, Knife, Square & Triangle Files.  
 Includes pouch for storage & organization.  
 Sale \$53.13 **Tool Club \$42.50**



**KDT82820H**  
**4PC 8" File Set**  
 Includes Flat, Round, Half Round & Triangle Files. Includes storage tray.  
 Sale \$91.19 **Tool Club \$72.95**



**IPA8108**  
**8" Diamond File Set**  
 Includes Half Round, Round, Flat & Square diamond coated files.  
 Cuts into welds & hardened surfaces where other files can't. Cuts 10x Faster & in all directions!  
 Sale \$103.13 **Tool Club \$82.50**



# MOUNT/DEMOUNT SPOONS



Part #	Length / Application	Sale	Club
KEN32117	16" (Pair) - Cycle / ATV	\$49.94	<b>\$39.95</b>
KEN32119	24" Straight - Car / Cycle / ATV	\$42.44	<b>\$33.95</b>
KEN33220	30" Curved - Truck / Tractor	\$49.94	<b>\$39.95</b>
KEN34747	36" Straight - Truck / Tractor	\$87.44	<b>\$69.95</b>
KEN34645	37" Rounded - Car / Truck / Tractor	\$87.44	<b>\$69.95</b>
KEN34645C	37" Tubeless - Car / Truck / Tractor	\$101.88	<b>\$81.50</b>
KEN34647	41" H.D. - Truck / Tractor	\$112.44	<b>\$89.95</b>

## KEN35442

### Truck Tire Service Set

Includes Blue Cobra dismount tool, tubeless tire iron, double-end tire spoon, 8 lb. bucket of Euro Paste Lube/Anti-rust, style lube applicator brush, aluminum C-Lok bead holder, and leather rim protector. Sale \$599.94 **Tool Club \$479.95**



## KEN35440

### Blue Cobra Truck Tire Dismount Tool

Sale \$449.94 **Tool Club \$359.95**



## AME71000

### Easy Buddy Tire Changing System

Mount and dismount tire for 22.5 & 24.5 tires/wheels. Includes Rim Protector, top bead removal tool & bottom bead removal tool. Sale \$393.69 **Tool Club \$314.95**



# Ken-Tool TIRE CAGES

Stay Safe While Inflating Tires Of Any Size!



Many More Sizes Available!

Part #	Description	Sale	Club
KEN36010	Super Magnum 5 Bar	\$1,749.94	<b>\$1,399.95</b>
KEN36007	Portable 2 Bar - 43.5" x 20.5"	\$524.94	<b>\$419.95</b>
KEN36001	Portable 2 Bar - 41" x 16"	\$524.94	<b>\$419.95</b>
KEN36002	4 Bar - 43.5 x 20.5"	\$874.94	<b>\$699.95</b>

## OTC5105B

### 1,100lb Capacity High-Lift Dual Wheel Dolly

Effortless air-powered hydraulic lift system for a variety of applications. 0 to 42" lifting range. Six-inch lateral adjustment. Tilt adjustment of +15° to -8° ensures easy alignment. Features four swivel casters, two locking, for enhanced mobility. Sale \$4,374.94 **Tool Club \$3,499.95**



## OTC1769A

### Truck Dual Wheel Dolly

Swivel casters, 3-1/2" front and 3" rear, provide easy maneuverability. Floor space is 43" by 42". Hydraulic jack provides over 6-1/2" of lift and tilts wheel assembly 7° to prevent damage to wheel seal. Includes a 6' support chain. Sale \$787.44 **Tool Club \$629.95**



## AST7449

### 20" Tire Iron Spoon Lever

Specially designed tip engages with the bead for easy removal. Sale \$24.94 **Tool Club \$19.95**



# CAP NUT WRENCHES

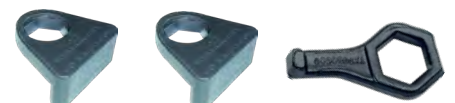

Part #	Style	Size	Sale	Club
KEN30618	SAE	1-1/2"	\$69.69	<b>\$55.75</b>
KEN30619	METRIC	41mm	\$66.88	<b>\$53.50</b>
KEN30612	METRIC	41mm	\$31.19	<b>\$24.95</b>

## LIS21520

### Truck Brake Pedal Depressor

Extends from 18-1/2" to 34-1/2" Sale \$54.94 **Tool Club \$43.95**



## KEN34950

### IRONMAN Ergonomic Wheel Lifting Bar

Lift all sizes and types of small, large, heavy & awkward truck tires & wheel assemblies. Sale \$106.19 **Tool Club \$84.95**



## WLT51136

### 11lb Head, 36" B.A.S.H.® Bead Breaking Wedge

Unbreakable® Handle Technology. |Steel core eliminates breaking during overstrikes. Sale \$205.94 **Tool Club \$164.75**



## KEN35429

### 32" Duck-Billed Bead Breaking Wedge with Fiberglass Handle

Breaks beads quickly & easily. Handle serves as a lever. Sale \$158.69 **Tool Club \$126.95**



## AFF3591

### Super Single Wheel Dolly

For large truck tires. 26" W carriage. Tire diam: 36" to 48". 450lb. Capacity. Sale \$184.38 **Tool Club \$147.50**



## KEN34549

### Dual Wheel Separator

For use on nearly any truck, bus, van, or trail that has dual steel wheels. Sale \$287.44 **Tool Club \$229.95**



# BEAD SEATERS



## KEN31444

### Mega AirBlast Bead Seater

For tires up to 24.5" in diameter. 5 gallon tank. Air pressure gauge and safety release valve included. Plastic nose clip protects wheels. Sale \$287.44 **Tool Club \$229.95**



## KEN31445

### Mega AirBlast™ Bead Seater Aluminum Tank

For tires up to 24.5" in diameter. 5 gallon tank. Used on Auto, ATV and Truck Tires. Sale \$312.44 **Tool Club \$249.95**



## TSICH5

### Cheetah Bead Seater

For commercial use on all tires from 4" - 24.5". 1-1/2" tank opening. 5 gallon ASME certified steel tank. Sale \$324.94 **Tool Club \$259.95**



**OTC4240A**

**King Pin Pusher**

Hydraulically removes and installs king pins, straight & tapered. Range: 7/8" - 2". Includes hydraulic pump. 30 ton capacity. Works on both straight and tapered kingpins. Works on a variety of trucks & buses. Sale \$3,124.94 **Tool Club \$2,499.<sup>95</sup>**



**OTC9850**

**21pc 6PT Wheel Bearing Locknut Sockets with Tool Board**

Sizes: 2-3/32" - 5-1/4"  
Sale \$1,024.94 **Tool Club \$819.<sup>95</sup>**



**OTC5668**

**Universal Cylinder Liner Puller**

Designed to be used with an impact wrench for quick cylinder liner removal. Spring loaded puller arms automatically adjust to fit the liner. Ranges from 3-7/8" - 6-1/4" bore diameters, sleeve depths of 15", & liner wall thickness of 0.273" minimum. Sale \$662.44 **Tool Club \$529.<sup>95</sup>**



**CTA5044**

**MACK Truck King Pin Socket**

Fits most MACK front axles (12,000 to 20,000 lbs.)  
Sale \$51.56 **Tool Club \$41.<sup>25</sup>**



**CTA5048**

**Engine Barring Socket MX13 Engine**

Applications: MACK E7 & CAT 3208  
Sale \$55.63 **Tool Club \$44.<sup>50</sup>**



**CTA5073**

**Cummins Engine Barring Tool - 5.9L**

Dodge Pickups with the 3.9L, 5.9L, 6.7L & 8.3L diesels engines and Cummins B/C Series diesels engines.  
Sale \$72.44 **Tool Club \$57.<sup>95</sup>**



**LIS49000**

**Truck Brake Cage Bolt Socket - 3/4"**

Extra deep 3/4" socket loosens cage bolt to unlock air brakes on trucks.  
Sale \$22.81 **Tool Club \$18.<sup>25</sup>**

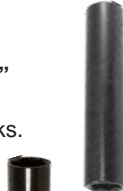

**LIS49020**

**Truck Cage Bolt Socket - 15/16"**

Extra deep socket. Can be used with an impact wrench.  
Sale \$27.81 **Tool Club \$22.<sup>25</sup>**



**LIS49040**

**Truck Brake Cage Bolt Socket - 1-1/16"**

Extra deep 1-1/16" socket loosens cage bolt to unlock air brakes on trucks.  
Sale \$28.69 **Tool Club \$22.<sup>95</sup>**



**LANG2577**

**8pc Floating Axle Housing Thread Restorer Kit**

7 thread restorer dies and one driver socket for use with 1/2" ratchet.  
Sale \$198.69 **Tool Club \$158.<sup>95</sup>**



**LOCK NUT SOCKETS**



AFF #	Desc. (PT)	Club	AFF #	Desc. (PT)	Club
18501	2-3/32" (6)	\$32. <sup>25</sup>	18521	2-1/2" (6)	\$32. <sup>50</sup>
18503	2-3/8" (8)	\$31. <sup>25</sup>	18522	2-5/8" (6)	\$32. <sup>00</sup>
18505	2-9/16" (8)	\$34. <sup>50</sup>	18523	2-3/4" (6)	\$33. <sup>50</sup>
18506	3" (6)	\$37. <sup>25</sup>	18524	3-3/8" (8)	\$38. <sup>25</sup>
18507	3" (8pt.)	\$37. <sup>00</sup>	18525	3-3/4" (8)	\$39. <sup>50</sup>
18508	3-1/4" (6)	\$35. <sup>50</sup>	18526	3-3/4" (6)	\$40. <sup>95</sup>
18509	3-1/4" (8)	\$33. <sup>25</sup>	18527	3-13/16" (8)	\$39. <sup>95</sup>
18510	3-1/2" (6)	\$35. <sup>25</sup>	18528	2-9/16" (6R)	\$31. <sup>95</sup>
18511	3-1/2" (8)	\$38. <sup>50</sup>	18532	2-7/8" (6)	\$33. <sup>50</sup>
18512	3-7/8" (6)	\$40. <sup>95</sup>	18533	2-7/8" (8)	\$36. <sup>50</sup>
18513	3-7/8" (8)	\$40. <sup>25</sup>	18534	3-1/8" (6)	\$39. <sup>95</sup>
18514	4" (6)	\$38. <sup>50</sup>	18535	3-1/8" (8)	\$37. <sup>95</sup>
18515	4-1/8" (6)	\$37. <sup>75</sup>	18536	2-3/8" (6R)	\$36. <sup>85</sup>
18516	4-3/8" (6)	\$58. <sup>25</sup>	18537	2-3/4" (8)	\$34. <sup>50</sup>
18517	4-3/8" (8)	\$51. <sup>25</sup>	18538	4-1/2" (8)	\$58. <sup>25</sup>
18518	4-7/8" (6)	\$59. <sup>95</sup>	18539	5-1/4" (6)	\$63. <sup>25</sup>
18519	4-7/8" (8p)	\$59. <sup>95</sup>	18540	4-1/8" (8)	\$53. <sup>75</sup>
18520	2-1/4" (6)	\$32. <sup>50</sup>	18541	4-13/16" (8)	\$67. <sup>95</sup>

**DIESEL FILTER WRENCHES FOR DAVCO**

Special design for removing and replacing main filter collar and vent cover on aftermarket diesel fuel filter systems.



Part #	Size	Sale	Club
LIS61090	5"	\$28.69	\$22. <sup>95</sup>
LIS61110	6"	\$33.69	\$26. <sup>95</sup>
LIS61130	8"	\$37.44	\$29. <sup>95</sup>

**LIS61140 Diesel Filter Wrench For Ford Transit**

For 2015 to current 150, 250, & 350 models.  
Sale \$32.44 **Tool Club \$25.<sup>95</sup>**



**LIS57180 Oil Filter Plug For Davco**

Used to plug the oil filter when changing oil on 2013-17 Dodge Ram Cummins 2500/3500 H.D. trucks.  
Sale \$13.69 **Tool Club \$10.<sup>95</sup>**



**LIS57060 5" Tractor Swivel Gripper**

Range: 4-3/4" - 5-3/16". Textured coating for superior gripping power. Swivel grip handle for tight spaces.  
Sale \$24.69 **Tool Club \$19.<sup>75</sup>**



**OTC9851**

**18pc 8PT Wheel Bearing Locknut Sockets with Tool Board**

Sizes: 2-3/8" - 4-1/2"  
Sale \$987.44 **Tool Club \$789.<sup>95</sup>**



**LIS28950**

**Truck Wheel Stud Installer**

Fits up to 22mm (7/8").  
Sale \$44.06 **Tool Club \$35.<sup>25</sup>**



**FORD AXLE SHAFT SEAL INSTALLER**



Correctly install the seal onto the axle shaft and into the wheel knuckle, preventing front hub vacuum leaks that would cause the 4WD to not engage.

**OTC6695**

**Ford Axle Shaft Seal Installer**

Application: '98 - '04 F250, F350, F450, F550.  
Sale \$135.63 **Tool Club \$108.<sup>50</sup>**

**OTC6697**

**Ford Axle Shaft Seal Installer**

Application: '05 - newer F250, F350.  
Sale \$149.94 **Tool Club \$119.<sup>95</sup>**

**OTC6698**

**Ford Axle Shaft Seal Installer**

Application: '05 - newer F450, F550.  
Sale \$168.69 **Tool Club \$134.<sup>95</sup>**

**CAL199**  
**Heavy Duty U-Joint Puller**  
 Used to remove the HD vehicle driveline u-joints on class 7 & 8 trucks using an impact wrench up to 1". Disassemble & reassemble u-joint cups without heat or hammering.  
 Sale \$171.56 **Tool Club \$137.25**



**TIG10201**  
**Bolt-Retained Bearing Cup Installer**  
 Fits virtually all h.d. trucks and machinery type u-joints.  
 Sale \$141.69  
**Tool Club \$113.35**



**TIG10217**  
**SPL Bearing Cup Installer**  
 For Dana / Spicer SPL Life Series quick-disconnect U-Joints.  
 Sale \$422.50  
**Tool Club \$338.00**



**TIG10310**  
**Tie Rod End Remover**  
 Provides a safe way to "shock" tie rod ends loose.  
 Sale \$225.63  
**Tool Club \$180.50**



**TIG10385**  
**Sheppard M100 Pitman Arm Puller**  
 For Sheppard M100 gearboxes. May be used with 3/4" impact wrench. Glove opening is 2.5" - 4.1" wide.  
 Sale \$422.50  
**Tool Club \$253.00**



**TIG10386**  
**H.D. Truck Pitman Arm Spreader**  
 For 2 ton and larger trucks. High strength pulling arms adjust to fit various widths.  
 Sale \$245.44  
**Tool Club \$196.35**



**TIG10389**  
**Sheppard M110 Pitman Arm Puller**  
 For use on Sheppard M110 gear boxes. Simple to slip on for easy results.  
 Sale \$367.44 **Tool Club \$293.95**



**TIG10908**  
**Bearing Race Starter Kit**  
 Install & remove bearing races easily! Requires a 20 ton shop press and at least one adapter kit to operate.  
 Sale \$918.69 **Tool Club \$734.95**



**TIG10406**  
**Manual Slack Adjuster Puller**  
 Removes all makes and models of manual slack adjusters. Use with 1/2" impact tool.  
 Sale \$316.25  
**Tool Club \$253.00**



**TIG10407**  
**Rockwell Slack Adjuster Puller**  
 Safely remove virtually all Rockwell self-adjusting slack adjusters. Use with 1/2" impact tool.  
 Sale \$316.25 **Tool Club \$253.00**



**TIG10409**  
**Gunite / Brunner / Bendix Slack Adjuster Puller**  
 Removes virtually all Gunite, Brunner, and Bendix self-adjusting slack adjusters. Use with 1/2" impact tool.  
 Sale \$316.25 **Tool Club \$253.00**



**TIG10410**  
**Haldex Multi Adjustable Slack Adjuster Puller**  
 Removes virtually all Haldex self-adjusting slack adjusters including left offset, right offset and standard elongated arm designs.  
 Sale \$387.19 **Tool Club \$309.75**



# TIGER TOOL

**TIG10501**  
**Brake Clevis Pin Press**  
 Instantly shears off the cotter pin as the clevis pin is easily removed. Fits almost all models of truck and trailer slack adjuster brake clevises.  
 Sale \$190.31  
**Tool Club \$152.25**



**TIG10502**  
**Slack Adjuster Rod Pin Press**  
 Instantly shears off the cotter pin allowing the 3/16" clevis pin to be easily removed. Fits virtually all makes and models of automatic slack adjuster rod pins.  
 Sale \$165.31  
**Tool Club \$132.25**



**TIG16002**  
**Brake Anchor Pin Press**  
 Remove brake anchor pins and bushings on all 16.5" S-Cam trailer and tractor "Q" brake systems. 10 ton capacity C-frame.  
 Sale \$405.31 **Tool Club \$324.25**



**TIG10803**  
**Heavy Duty Yoke Puller**  
 For removal of h.d. yokes on drive shafts, transmissions, and rear-end differentials without damage to yokes or other components. 25,000 lbs of pulling power.  
 Sale \$754.69 **Tool Club \$603.75**



**TIG15200**  
**Tapered Torque Rod Press**  
 Efficiently & effectively removes transverse torque rods found on Neway & Hendrickson suspensions. For use with a 1" impact tool. Eliminates hammering & potential damage to surrounding components.  
 Sale \$624.99  
**Tool Club \$499.99**



**TIG11001**  
**Axle Shaft Puller**  
 Pullcams preload behind the axle flange allowing the cone washers to be released with ease. For use on medium to h.d. Eaton and Rockwell drive axles.  
 Sale \$516.88  
**Tool Club \$413.50**



**TIG15111**  
**Leaf Spring Pin Socket Set**  
 For International, Peterbilt, Kenworth, Volvo, & Mack suspensions.  
 Sale \$438.13  
**Tool Club \$350.50**



**TIG90102**  
**H.D. Strut Compressor**  
 15" - 25" center to center working range. Eliminates dangerous ratchet strap and pry-bar methods.  
 Sale \$548.44 **Tool Club \$438.75**



**TIG90150**  
**H.D. King Pin Press**  
 46,000 lbs of force. Weighs only 30 lbs! Anti-torque arms prevent twisting of the main body. For use on straight and tapered king pins from 7/8" - 2-5/32".  
 Sale \$2,324.38  
**Tool Club \$1,859.50**



**TIG15042**  
**Hendrickson FIREMAAX / PRIMAAX Bushing Adapter**  
 Easily remove and install FIREMAAX & PRIMAAX bushing while the suspension remains on the vehicle.  
 Sale \$715.31 **Tool Club \$572.25**





**BALL JOINT**

**OTC6530 Master Ball Joint Press**

Includes: All adapters for pressed on ball joints, including ones needed for 4WD, SUV's and light trucks.  
Sale \$587.44 **Tool Club \$469.95**



**OTC7249 Ball Joint Press**

Removes and installs ball joints, universal joints, and truck brake anchor pins.  
Sale \$212.44  
**Tool Club \$169.95**



**AST7865 Ball Joint Press**

Removes and installs ball joints, universal joints and truck brake anchor pins.  
Sale \$106.19  
**Tool Club \$84.95**



**AST7868 Ball Joint Adapters**

Allows a ball joint press to work on most 4WD's & light trucks.  
Sale \$99.06  
**Tool Club \$79.25**



**AST78830 Heavy Duty Hub Drum & Rotor Puller Kit**

Use with impact wrench to remove hubs, drums and brake rotors (dics). Durable forged design, made from same alloy used on Astro's famous ball joint presses. Use with 1-1/4" socket and 1-1/4" or 32mm wrench. Drum & Rotor pulling arms include raised stops for use with ratchet straps (not included) for especially difficult applications. Includes three different hub adapters to fit all types of hub sizes.  
Sale \$174.94 **Tool Club \$139.95**

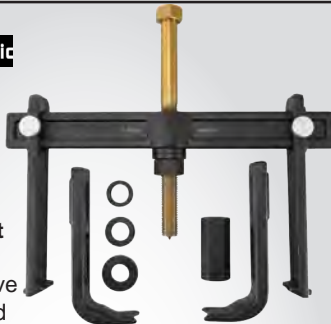

**SY11100 Manual Bushing Removal and Installation Kit**

Service a wide range of bushings without removing components from the vehicle. Comes with 22 cups and receivers for 100's of size combinations. 4 acme thread spindles 10, 12, 14 & 16mm featuring ball bearing thrust washers.  
Sale \$643.69 **Tool Club \$514.95**



**OTC6539 55pc Ball Joint Service Kit (Trucks/Van/SUV)**

Covers press in ball joints on the following Truck/Van/SUV applications: Toyota, Hyundai, KIA, Infinity, Isuzu, Nissan, Chrysler, Dodge, Jeep, Plymouth, Mitsubishi, Ford, Lincoln, Mercury, Mazda, Chevrolet, Buick, Oldsmobile, Pontiac, Cadillac, GMC, Hummer up to 2008.  
Sale \$1,249.94  
**Tool Club \$999.95**

**AST7897 Master Ball Joint Press**

Includes: Press plus all adapters. For all cars and light trucks.  
Sale \$209.94  
**Tool Club \$167.95**



**AST78825 Master Front Wheel Drive Bearing Adapter Kit**

Replace wheel bearings without the need for alignment after by keeping the strut assembly and steering knuckle in place.  
Sale \$137.44  
**Tool Club \$109.95**



**OTC6736 Large C-Frame**  
Required for use with Sprinter Van Ball Joint Kit. Large C-Frame & forcing screw assembly  
Sale \$187.44  
**Tool Club \$149.95**



**AST78100 Goliath Ball Joint XL C-Frame Press**  
Includes both long and short drive screws to maintain a shorter overall working length when desired  
Sale \$106.19  
**Tool Club \$84.95**



**AST78912 Low Profile Ball Joint Separator**  
Designed for tight access where most ball joint separators won't fit. Particularly useful on 2005+ Ford, Lincoln & Mercury applications. Impact rated durable forge design.  
Sale \$62.44 **Tool Club \$49.95**



**CTA1082 Mercedes Ball Joint Socket - 4 Lug**  
Sale \$69.94  
**Tool Club \$55.95**



**FRONT END**



**OTC6575 Hub Grappler™**

Complete solution for servicing wheel hubs and bearings on the vehicle without removing the steering components or knuckle. Application coverage up to 2009 model year. Includes carrying case and application guide.  
Sale \$862.44 **Tool Club \$689.95**



**WILW89303 5pc Front-End Service Set**

For removal of most types of pitman arms, tie rods and ball joints found on automotive and light truck applications.  
Sale \$137.44 **Tool Club \$109.95**



**CTA4305 Front Hub Puller**  
Sale \$67.81  
**Tool Club \$54.25**



**OTC7394 Hub Puller**  
Arms adjust to 7-1/2".  
Sale \$199.94  
**Tool Club \$159.95**



**OTC6290A Front Hub Puller**  
For 4WD vehicles.  
Sale \$249.94  
**Tool Club \$199.95**



**OTC7315A Tie Rod End Puller**  
Fits most front wheel drive cars.  
Sale \$69.94  
**Tool Club \$55.95**



**LIS39250 Front Hub & Knuckle Separator**  
For 2003+ 4WD 3/4 & 1 ton Dodge.  
Use with air hammer.  
Sale \$28.69  
**Tool Club \$22.95**



**LIS39300 Front Hub & Knuckle Separator**  
Use with air hammer.  
Sale \$27.44  
**Tool Club \$21.95**



## FRONT END



**MAY31940**  
**5pc Pneumatic Separating Fork Set**  
 Handles ball joints with minimal shock to the assembly. .401 shank.  
 11/16", 15/16", 1-11/16", 1-3/8", 1-1/8".  
 Sale \$178.69 **Tool Club \$142.95**

**LIS41440**  
**5pc Stepped Pickle Fork Kit**  
 Sizes: 1-1/8", 11/16", 15/16", 1-5/8", 1-7/16".  
 Handle & pneumatic driver.  
 Sale \$124.94 **Tool Club \$99.95**



**LIS41400**  
**Stepped Pickle Fork Kit**  
 Includes 3 Forks.  
 Sizes: 1-1/8", 11/16" & 15/16" Handle and pneumatic driver.  
 Sale \$70.63 **Tool Club \$56.50**



**LIS18520**  
**Tie Rod Fork**  
 21/32" opening.  
 Sale \$26.88 **Tool Club \$21.50**



**LIS18530**  
**Ball Joint Fork**  
 15/16" opening.  
 Sale \$26.88 **Tool Club \$21.50**



**TA61900**  
**Ball Joint & Tie Rod Puller**  
 Separate tie rod ends & ball joints.  
 Sale \$29.94 **Tool Club \$23.95**



**CAL18510**  
**Bolt Retained Bearing Cup Installer**  
 Quickly & easily installs bearing cups on bolt retained universal joints. Fits series 1610 to 1880 and nearly all heavy-duty truck & machine U-Joints with bolt retained bearing cups.  
 Sale \$39.38 **Tool Club \$31.50**



**TA61800**  
**Strut Alignment Gauge**  
 Sale \$44.69  
**Tool Club \$35.75**



**CTA4040**  
**GM Torsion Bar Tool**  
 For 88 - 10 GM.  
 Sale \$105.63  
**Tool Club \$84.50**



**CTA4045**  
**GM Torsion Bar Tool - Large**  
 For 2011 & up HD C/K GM trucks.  
 Sale \$99.94  
**Tool Club \$79.95**



## PITMAN ARM

**LIS41900**  
**Pitman Arm Puller**  
 Sale \$36.19  
**Tool Club \$28.95**



**KDT2289D**  
**Pitman Arm Puller** **GEARWRENCH**  
 Sale \$45.63  
**Tool Club \$36.50**



**OTC8150**  
**HD Conical Pitman Arm Puller**  
 Works on most cars and light trucks.  
 Sale \$87.44  
**Tool Club \$69.95**



**OTC7311A**  
**Pitman Arm Puller**  
 Arms adjust to 2-1/8".  
 Fits cars & trucks up to 3/4 ton.  
 Sale \$111.88  
**Tool Club \$89.50**



**OTC7310A**  
**Pitman Arm Puller**  
 Arms adjust to 2-1/4".  
 Fits medium and heavy trucks.  
 Sale \$121.88  
**Tool Club \$97.50**



**OTC6497**  
**Super Duty Pitman Arm Puller**  
 Arms adjust to 3-1/4".  
 Fits 2005 & newer Ford F-250 & F-350 Super Duty trucks.  
 Sale \$136.88  
**Tool Club \$109.50**



**CAL18620**  
**Sheppard M100 Pitman Arm Puller**  
 Easily remove uncooperative pitman arms on Sheppard M100 gear boxes. Can be used with up to a 3/4" impact tool.  
 Sale \$93.69 **Tool Club \$74.95**



**CAL18630**  
**Sheppard M110 Pitman Arm Puller**  
 Easily remove uncooperative pitman arms on Sheppard M110 gear boxes. Can be used with up to a 3/4" impact tool.  
 Sale \$162.44 **Tool Club \$129.95**



**CAL18640**  
**Intermediate Pitman Arm Puller**  
 Easily removes stubborn pitman arms on intermediate vehicles. May be used with up to a 1/2" impact tool.  
 Sale \$137.44 **Tool Club \$109.95**



**CTA4017**  
**Axle Popper Set**  
 Separates half-shafts from transaxle. Shim tool to fill gaps. 14" long with 2" openings.  
 Sale \$66.88 **Tool Club \$53.50**



## MCPHERSON STRUT

**BRA7600**  
**Strut Compressor**  
 This features a floating compression head for angled springs. Lower compression hooks easily fit between tight springs. New, updated design.  
 Sale \$1,249.94  
**Tool Club \$999.95**



**OTC6494**  
**Strut Compressor**  
 Range from 4" to 9".  
 Can be used with an impact gun.  
 Sale \$374.94  
**Tool Club \$299.95**



**LIS62300**  
**Strut Compressor**  
 Extra narrow design will fit on many imports where others will not.  
 Sale \$84.38  
**Tool Club \$67.50**



**TA62900**  
**Strut Compressor**  
 This is the most popular compressor made. Handles springs up to 6".  
 Sale \$74.94  
**Tool Club \$59.95**



**CTA4030**  
**Internal Coil Spring Compressor**  
 Removes, installs & compresses coil springs. For coil springs that can't be reached from the center.  
 Sale \$68.75  
**Tool Club \$55.00**



Compressor with a Strut Assembly



**CAL91300**  
**Floor Mounted 2,200lb Strut Compressor**  
 Can be used with varying sizes of struts with coils up to 5/8" diameter. Ideal for passenger vehicles and light-trucks. Designed for easy, one-person use  
 Sale \$437.44  
**Tool Club \$349.95**



## GM CAMSHAFT



**CTA5054**  
**GM Cam Phaser Locking Tool**  
 Locks both cam phasers so the phaser bolts may be serviced. Good for GM 2.0L and 2.4L EcoTec engines.  
 Sale \$99.94 **Tool Club \$79.95**



**CTA7677**  
**3pc GM Cam Holder Kit**  
 2.8L, 3.0L & 3.6L  
 Services left & right head for 2006+ 2.8L, 3.0L and 3.6L V6 GM engines. Prevents rotation during timing chain service.  
 Sale \$81.19 **Tool Club \$64.95**



**CTA1046**  
**GM Timing Tool Kit 1.4L Ecotec**  
 For 2011 & up GM models with the 1.4L Ecotec engine. Applications: Chevy Cruz, Sonic & Trax  
 Sale \$262.44 **Tool Club \$209.95**



**CTA4161**  
**GM Camshaft Locking Tool Kit - 1.6/1.8**  
 For GM 1.6L & 1.8L 16v engines. Applications: Aveo, Cruze, G3, 9-5, Alfa Romeo & Fiat from 2003-2012  
 Sale \$81.19 **Tool Club \$64.95**



**OTC6687**  
**GM 6-Cylinder Cam Tool Set**  
 Used to adjust & hold cam shaft timing on GM 3.0 & 3.2 V-6 engines.  
 Sale \$299.94 **Tool Club \$239.95**



**OTC6685**  
**GM In-Line 4-Cylinder Cam Tool Set**  
 Designed to save time when servicing GM 4-cylinder engines.  
 Sale \$462.44 **Tool Club \$369.95**

## BENZ CAMSHAFT



**CTA5080**  
**Benz Timing Tool Kit - M156**  
 Applications: CLK63 AMG, CLS63 AMG, E63 AMG, ML63 AMG, R63 AMG, CL63 AMG, S63 AMG & C63 AMG  
 Sale \$374.94 **Tool Club \$299.95**



**CTA5190**  
**Benz Timing Tool Kit**  
 For M133 / M270 / M274.  
 Specially designed to position the camshafts in TDC position. Slackens and tightens the bolts attached to the camshaft gears.  
 Sale \$431.19 **Tool Club \$344.95**



**CTA1073**  
**Benz/Jeep Diesel Engine Timing Tool Kit 1.8L, 2.1L & 2.2L**  
 Includes set of camshaft holders plus crankshaft pulley install/removal/turning tool. For '07 & up Benz OM651 engines, including A, B, C, CLA, CLS, E, GLK, M, S, & SLK Class, Sprinter, Jeep Compass and Dodge Caliber. All steel precision-machined construction. Packed in a blow mold case.  
 Sale \$162.44 **Tool Club \$129.95**

## VOLVO CAMSHAFT



**CTA2863**  
**Volvo Cam/Crank Alignment Kit**  
 Services all 850, 960, S70, C70, C30, V50, S40, '01-'09 S60, '99-'06 S80, '98-'07 V70, '98-'07 XC70 & V70XC, '03-'06 XC90 w/5 cyl., '03-'06 XC90 w/6 cyl.  
 Sale \$387.44 **Tool Club \$309.95**



**CTA2864**  
**Cam Locking Tool for Volvo**  
 Services Volvo 850, S40, S70 & S90. For alignment of the cam & crankshafts.  
 Sale \$160.63 **Tool Club \$128.50**



**CTA7635**  
**Volvo/Ford Crankshaft Counter Holder**  
 Used to counter-hold the crankshaft pulley to release & tighten the center bolt.  
 Sale \$68.69 **Tool Club \$54.95**

## CAMSHAFT TOOLS



**LIS36880**  
**Dual Cam Holding Tool**  
 Locks cams in place during belt/chain replacement.  
 Sale \$45.63 **Tool Club \$36.50**



**CTA7615**  
**Subaru Camshaft Holder**  
 Holds camshaft sprockets on 2005 & up Subaru models w/ 2.5L Turbo & 3.6L engines.  
 Sale \$68.69 **Tool Club \$54.95**



**CTA2243**  
**Camshaft Pulley Holder - Subaru**  
 For 2002-05 Subaru Impreza 2.0 Turbo & 2000 Subaru Forester L F4-2.5L SOHC. Will not fit 2005 2.0 Turbos with variable cam timing.  
 Sale \$61.19 **Tool Club \$48.95**



**CTA2715**  
**Tension Pulley Spanner - Mitsubishi / Hyundai / Chrysler**  
 Adjusts timing belts that have idler pulleys with pin holes. 10.85mm (.428") pins.  
 Sale \$25.63 **Tool Club \$20.50**



**CTA2857L**  
**5pc Master Cam Locking Kit**  
 Services Fiat, Ford, Honda, Hyundai, Mazda, Mitsubishi, Nissan, Saab, Subaru, Toyota, Volvo & more! Includes adjustable clamping tool & 4 mini clamps.  
 Sale \$69.38 **Tool Club \$55.50**



**CTA7600**  
**Subaru Crankshaft Pulley Holder**  
 4-point design. Applications Subaru Forester (2011 & Up), WRX (2014 & Up), Impreza (2013 & Up), Impreza XV 2.0 (2012 & Up), Tribeca 3.6 (2008-2012). Sale \$62.44 **Tool Club \$49.95**



**CTA1036**  
**VW/Audi Camshaft Adjuster Socket - 2.0L**  
 Services camshaft adjuster bolts.  
 Sale \$18.13 **Tool Club \$14.50**



**CTA5000**  
**Cam Phaser & Timing Chain Locking/Holding Set**  
 Applications: 2011 and newer Chrysler, Dodge and Jeep models with 3.0L, 3.2L & 3.6L Pentastar engines.  
 Sale \$181.19 **Tool Club \$144.95**



**CTA7605**  
**Subaru Camshaft Pulley Holder**  
 4-point design. Applications include: Forester 2.0 (2005-2011), Impreza 1.6 / 2.0 (2005-2008), Legacy (2005 & Up), Legacy CVT (2010-2013).  
 Sale \$64.38 **Tool Club \$51.50**



**CTA4333**  
**Adjustable Master Camshaft Pulley Holder**  
 For Mercedes, BMW, Ford, Honda, Audi, VW, and more! Adjustable Range: 21mm - 100mm.  
 Sale \$112.44 **Tool Club \$89.95**



**CTA7625**  
**Subaru Crankshaft Pulley Holder**  
 3-Point design to hold the AVICS intake camshaft pulleys when removing or installing the central bolt, avoiding damage to central pulley.  
 Sale \$51.88 **Tool Club \$41.50**



# VW / AUDI CAMSHAFT TOOLS

TIMING TOOLS



**CTA2865**  
**Twin Camshaft Holder**  
 Applications: VW/Audi V6 w/  
 2 valves per cylinder.  
 Sale \$120.63 **Tool Club \$96.50**



**CTA2762**  
**VW/Audi Camshaft Drivebelt Pulley Puller Kit**  
 For 4 & 6 cylinder TDI & V6, V8 engines.  
 Includes: 3 single arm jaws, 3 double arm jaws,  
 yoke, and center screw.  
 Sale \$168.44 **Tool Club \$134.75**



**CTA2870**  
**Camshaft Holder Kit - Audi 3.0 L**  
 For Audi A4, A6 and A8 2000-2007  
 with AVK engine. Includes holders,  
 lock pin tool, socket, and set of pins.  
 Sale \$249.94 **Tool Club \$199.95**



**CTA2867**  
**Twin Camshaft Holder**  
 Applications: VW/Audi V6 2.7L  
 & 2.8L w/ 5 valves per cylinder.  
 Sale \$124.94 **Tool Club \$99.95**



**CTA1414**  
**VW/Audi Timing Tool Kit - 4.2L**  
 VW/Audi Factory Tool #T40047, T40046, T3242  
 & T40058. Includes Camshaft locking bars,  
 TDC Lock Pin & Setting Tool.  
 Sale \$190.63 **Tool Club \$152.50**

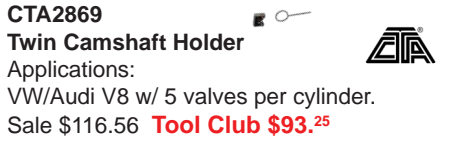

**CTA2869**  
**Twin Camshaft Holder**  
 Applications:  
 VW/Audi V8 w/ 5 valves per cylinder.  
 Sale \$116.56 **Tool Club \$93.25**



**CTA2775**  
**VW TDI Timing Belt Tool Kit**  
 For '99 and up 1.9L TDI engines with  
 ALH code found on Golf, Jetta, & Beetle.  
 Sale \$65.31 **Tool Club \$52.25**

**WORKS WITH**  
**#2865, 2867 & 2869**

**CTA2872**  
**TDC Lock Pin for VW/Audi**  
 Locks the crankshaft at TDC.  
 Sale \$31.25  
**Tool Club \$25.00**



**CTA1032**  
**3pc V.A.G. Camshaft Adjusting Socket Set**  
 For removal and installation of 4/3 way  
 central valve for camshaft adjustment  
 on 1.8 & 2.0 generation III TFSI engines.  
 3 sizes with unique 2 pin positions.  
 Sale \$44.94 **Tool Club \$35.95**

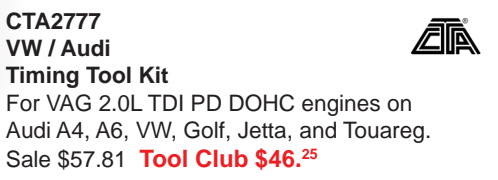

**CTA2777**  
**VW / Audi Timing Tool Kit**  
 For VAG 2.0L TDI PD DOHC engines on  
 Audi A4, A6, VW, Golf, Jetta, and Touareg.  
 Sale \$57.81 **Tool Club \$46.25**



**CTA2858**  
**VW Crankshaft Holder**  
 For 04-10 VW Golf,  
 Jetta, and New Beetle  
 with TDI Pump Duse.  
 Sale \$25.31 **Tool Club \$20.25**



**CTA2765**  
**6pc Audi/VW Timing Belt Wrench Set - 1.9L & 2.0L**  
 Includes 3 belt tensioner wrenches & 3 lock pins.  
 Works on some TDI Engines (Diesel)  
 Sale \$97.44 **Tool Club \$77.95**



**CTA2889**  
**VW / Audi 2.0L Turbo Timing Kit**  
 Services '09 & up models with turbo engines.  
 Includes crank counter hold tool, crankshaft  
 thrust piece, (4) drift for camshaft slide pieces, (2)  
 locking clips, (2) camshaft clips, (1) assembly tool.  
 Sale \$241.19 **Tool Club \$192.95**



**CTA2878**  
**VW / Audi Camshaft Locking Tool**  
 Services 2006 - 2008  
 VW / Audi 2.0L Turbo engines.  
 Sale \$57.81 **Tool Club \$46.25**



**CTA2760**  
**VW/Audi Adjustable Timing Belt Tensioner**  
 1.5L, 1.6L, 1.7L, 1.8L, 1.9L 2.0L  
 Services VW / Audi 4 cylinder  
 1.5, 1.6, 1.7, 1.8, 1.9 and 2.0L engines.  
 OAL: 7-1/2" / 19cm  
 Sale \$43.69 **Tool Club \$34.95**



**CTA1085**  
**Audi Camshaft Holding Tool**  
 For assembly and disassembly of pulleys on  
 camshaft, vibration and oil pump. Includes 2 sets  
 of pins, one with 3-steps for a total of 4 diameters.  
 Sale \$66.56 **Tool Club \$53.25**



**CTA2874**  
**Cam Chain Tensioned Retainer**  
 Holds the chain and tensioner  
 in the correct position.  
 Sale \$21.88 **Tool Club \$17.50**



**CTA3830**  
**VW TDI Timing Belt Tool Kit**  
 Used to properly lock & time the TDi EA288  
 diesel engine for 2015+ VW models.  
 2015+ TDi models with engine codes "CVCA"  
 & "CRUA". 2015+ Jetta TDi, Golf TDi, Golf  
 Sportwagen TDi, Beetle TDi & Passat TDi  
 Sale \$186.88 **Tool Club \$149.50**



**CTA8091**  
**VW TDI Timing Belt Tool Kit - 1.9L**  
 Sets & adjusts timing on '99 - '08 VW TDI engines.  
 Includes: Lock pins, Cam Lock Bar, Spanner  
 Wrench and Crankshaft Holders.  
 Packed in blow mold case.  
 Sale \$182.44 **Tool Club \$145.95**



**CTA1023**  
**V.A.G. Timing Tool Kit - 1.8L & 2.0L (TSI / TFSI)**  
 Includes 3pc V.A.G. camshaft adjusting socket |  
 set - 2.0L (TFSI), VW/Audi 2.0T Timing Kit - 2.0L  
 (TFSI), and VW Chain Tensioner Lever.  
 Sale \$312.44 **Tool Club \$249.95**

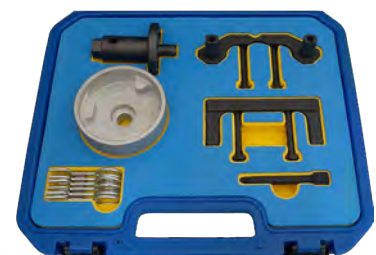

**CTA5013**  
**Audi A8 4.0L Timing Tool Kit**  
 Applications: Audi A6, A7 & A8 equipped with  
 the V8 4.0L TFSI direct injection engine  
 Sale \$362.44 **Tool Club \$289.95**

**FORD CAMSHAFT TOOLS**



**OTC6690 Ford Master Cam Tool Kit**  
 • Combination of OTC6489 & OTC6690-1.  
 • Adjust cam timing on ANY Ford car or truck with a timing chain or belt.  
 • Works on vehicles from mid 1990's to today's current model year vehicles.  
 • Works on 4 cylinder, 6 cylinder, V-8, & V-10 engine configurations.  
 • Contains 40 tools and an application chart.  
 Sale \$1,112.44 **Tool Club \$889.95**

**ALL IN-ONE KIT FOR FORD**



**OTC6690-1 Ford Cam Tool Update Kit**  
 Add on set for OTC6489 - making the kit into the OTC6690. Covers L4, V6, V8, V10 engines w/ 3V & 4V valve configurations 2004 - present.  
 Sale \$662.44 **Tool Club \$529.95**

**CTA7640U Ford Camshaft Locking Kit - 4.6L, 5.4L & 6.8L 3V**  
 One tool locks camshaft and the other locks the timing chain.  
 Sale \$145.63 **Tool Club \$116.50**



**OTC6489 Ford Cam Tool Set**  
 Master set has 22 cam tools covering 1992+ Ford engines, over 50 applications. Includes cam positioning tools, cam sensor sync tools, and more.  
 Sale \$687.44 **Tool Club \$549.95**



**CTA5063 Ford/Mazda Timing Tool Kit**  
 Services Ford, Lincoln & Mazda 1.4L, 1.5L, 1.6L, 2.0L, 2.3L, 2.5L, 3.0L & 3.5L engines  
 Sale \$349.94 **Tool Club \$279.95**

**LIS37200 Ford Timing Tool with Tensioner**  
 For use when servicing the timing chain on Ford V6 3.5L & 3.7L Engines  
 Sale \$62.44 **Tool Club \$49.95**

**CTA2743 Ford 1.6L EcoBoost Engine Service Kit**  
 Includes timing & seal service tools.  
 Sale \$131.19 **Tool Club \$104.95**



**OTC6488 7pc Ford Cam Tool Set**  
 For 1997 - 2011 4.0L Explorer / Mountaineer SOHC V6 engines.  
 Sale \$393.69 **Tool Club \$314.95**

**OTC6681 Ford Cam Tool Set**  
 For use on Ford 4.6L, 5.4L & 6.8L 3V engines  
 Sale \$74.94 **Tool Club \$59.95**

**CTA2880 Ford / Mazda Cam Alignment Tool**  
 Services '04-'09 Mazda 3, '06 - '10 Mazda 5, '05 - '08 Ford Escape, '03 - '07 Ford Focus, '06 - '09 Ford Fusion and including all HWDA, HWDB, & HXDA engines.  
 Sale \$41.88 **Tool Club \$33.50**

**CTA2884 Ford / Mazda Cam Alignment Tool**  
 2.0L & 2.3L twin cam turbo engines.  
 Sale \$32.19 **Tool Club \$25.75**

**LIS37410 Ford Cam Tool Kit**  
 2.0L, 4 cylinder DOHC Zetec.  
 Sale \$41.19 **Tool Club \$32.95**

**CTA1090 Ford VCT Alignment Tool**  
 1.5L & 1.6L  
 Services '11-'14 Fiesta, '13-'14 Escape, Fusion & Transit  
 Sale \$38.69 **Tool Club \$30.95**

**BMW CAMSHAFT**

**CTA2886U BMW Timing Tool Kit**  
 For use on BMW N51, N52, N53, N54, & N55 engines. 2006 & up 1, 3, 5, and X5 series with 3.0: (non-turbo) and 3.0L Twin Turbo engines. Sets cam, valve, and VANOS timing.  
 Sale \$474.94 **Tool Club \$379.95**



**CTA2888 BMW Timing Tool Kit**  
 Properly aligns and locks camshaft in TDC position for N62, N62TU, & N73 engines. Includes complete set of tools including hold-down tool & crankshaft timing pin.  
 Sale \$381.19 **Tool Club \$304.95**

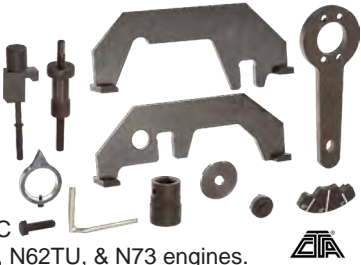

**CTA2887 BMW V8 Camshaft Alignment Tool Kit - M60, M62 & M62TU**  
 Includes 4 blocks & 2 locking fixtures for setting camshaft timing.  
 Sale \$362.44 **Tool Club \$289.95**



**CTA2885 BMW 4 & 6 Cylinder Camshaft Alignment Tools**  
 Includes jig to align camshafts & TDC pin. Services BMW M42, M44, M50, M52, M52TU, M54, M56, S50US & S52US engines.  
 Sale \$124.94 **Tool Club \$99.95**



**CTA2805 BMW Timing Tool Kit B38/B48 - 1.5L & 2.0L**  
 Designed for locking the crankshaft and camshafts. For correctly setting the timing position while servicing.  
 Sale \$437.19 **Tool Club \$349.75**

**CTA7675 BMW Timing Tool Kit - N20/N26**  
 Aligns camshaft timing at TDC position on N20/N26 engines.  
 Sale \$449.94 **Tool Club \$359.95**

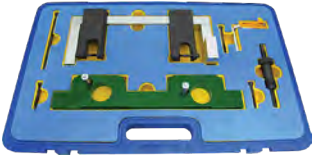

**CTA2895 BMW Timing Tool Kit M52, M54, M56**  
 Includes alignment jig, chain tensioner, VANOS compressed air connector.  
 Sale \$437.44 **Tool Club \$349.95**



**CTA2893 BMW Timing Tool Kit - N63**  
 Includes TDC pin. Services all N63 V8 including '09 & up 750i, '11' & up Alpina B7, '10 & up 550i, & '12 & up 650i.  
 Sale \$305.94 **Tool Club \$244.75**



**CTA2894 BMW Timing Tool Kit M60, M62**  
 Includes alignment fixtures, chain tensioner, chain tensioner locking springs, crankshaft pins, and VANOS tools. Services BMW from '92 - '03. Range Rover from '03 - '05.  
 Sale \$499.94 **Tool Club \$399.95**



**CTA7643 BMW Crankshaft Front and Rear Seal Removal & Installer Kit**  
 Services N40, N42, N45, N45T, N46, N46T, N52, N52K, N53, N54 & N55.  
 Sale \$487.44 **Tool Club \$389.95**





**CTA2112**  
**Valve Spring Compressor Kit**  
 Replaces valve spring & valve stem seals without removing the cylinder head on most BMW, VW, Audi and Volvo models.  
 Sale \$124.94 **Tool Club \$99.<sup>95</sup>**



**CTA2235**  
**Overhead Valve Spring Compressor**  
 Fits all engines with the head on or off of the car. Will fit into the most recessed valve spring.  
 Sale \$133.13 **Tool Club \$106.<sup>50</sup>**

## VALVE TOOLS

**CTA2231**  
**Overhead Valve Spring Compressor**  
 Removes valve spring keepers and springs without removing the cylinder head. Adjusts to fit springs on most cars. Sliding "T" handle for close clearances.  
 Sale \$30.94 **Tool Club \$24.<sup>75</sup>**



**LIS44300**  
**Valve Spring Compressor** **NEW!**  
 High leverage allows one-handed operation. Exceptionally strong, rigid frame. Works with nearly all valve-in head & L-head engines, as well as truck & tractor engines.  
 Sale \$124.94 **Tool Club \$99.<sup>95</sup>**



**KDT2833D** **GEARWRENCH**  
**Glaze Breaker**  
 Fits cylinders 2" to 7".  
 Sale \$44.38 **Tool Club \$35.<sup>50</sup>**



**LIS23500**  
**Glaze Breaker**  
 For cylinders 2" to 7"  
 Sale \$37.44 **Tool Club \$29.<sup>95</sup>**

**LIS58430**  
**Camshaft Seal Puller**  
 Removes without damage.  
 Sale \$23.13  
**Tool Club \$18.<sup>50</sup>**



**CTA1092**  
**Ford Valve Spring Compressor**  
 For 1991 & up Ford 4.6L 2 valve, V8 engines.  
 Sale \$56.25  
**Tool Club \$45.<sup>00</sup>**



**CTA7639**  
**Ford Valve Compressor**  
 Services Ford vehicles with 4.6L, 5.4L & 6.8L 3V Engines  
 Sale \$68.69  
**Tool Club \$54.<sup>95</sup>**



**LIS36050**  
**Valve Keeper Tool** **Lisle**  
 Works on most overhead valve engines with valve stems from 4.5 to 7.5 mm & 5/16" to 3/8".  
 Sale \$94.94  
**Tool Club \$75.<sup>95</sup>**



**LIS36200**  
**Valve Keeper Tool**  
 Push or tap with hammer to remove or install keepers.  
 Sale \$52.44  
**Tool Club \$41.<sup>95</sup>**



**LIS33500**  
**Piston Ring Installer**  
 Sale \$9.38  
**Tool Club \$7.<sup>50</sup>**



**KDT124DD**  
**Remote Starter Switch**  
 Controls any engine with solenoid starter switch.  
 Sale \$23.69  
**Tool Club \$18.<sup>95</sup>**



**CTA3012**  
**Remote Control Starter Switch** **ATA**  
 Controls any engine with solenoid starter switch.  
 Sale \$16.19  
**Tool Club \$12.<sup>95</sup>**



**LANG3275A**  
**26 Blade Offset Feeler Gauge**  
 Sizes: 0.005" - 0.030"  
 Sale \$17.19  
**Tool Club \$13.<sup>75</sup>**



**SY88950**  
**10mm Universal Valve Adjustment Tool**  
 For 10mm jam nuts.  
 Sale \$44.38 **Tool Club \$35.<sup>50</sup>**



**SY88800**  
**12mm Universal Valve Adjustment Tool**  
 For Honda, Toyota, Nissan, & VW.  
 Sale \$44.38 **Tool Club \$35.<sup>50</sup>**



## PISTON RING COMPRESSOR

**KDT850DD**  
**Piston Ring Compressor Set**  
 Sale \$110.94  
**Tool Club \$88.<sup>75</sup>**



**RANGE 2-7/8" TO 4-3/8". RATCHETING PLIERS GIVE EXTRA FINE CONTROL**

**CTA2020**  
**Piston Ring Compressor Set**  
 Sale \$77.81  
**Tool Club \$62.<sup>25</sup>**



**LIS19500**  
**Range: 2-1/8" to 5"**  
 Sale \$22.81  
**Tool Club \$18.<sup>25</sup>**



**LIS20500**  
**Range: 3-1/2" to 7"**  
 Sale \$22.81  
**Tool Club \$18.<sup>25</sup>**



**LIS21000**  
**Diesel Ring Compressor**  
 Range: 3-1/2" - 7"; Height: 7"  
 Sale \$46.88  
**Tool Club \$37.<sup>50</sup>**



**LIS21500**  
**Diesel Ring Compressor**  
 Range: 7" - 10"; Height: 7"  
 Sale \$54.94  
**Tool Club \$43.<sup>95</sup>**



**CTA7810**  
**Injector Seat and Chamber Cleaning Set**

Includes:  
 (2) metal brushes (Ø 20mm & 25mm) for injector hole cleaning, (2) front brushes for injector seat cleaning  
 (1) front brush extension  
 (2) seal plugs to close injector hole while cleaning  
 (1) seal plug holder to place & remove plug  
 (1) sanding kit with paper and paper support  
 Sale \$129.94 **Tool Club \$103.<sup>95</sup>**



## FLEX HONES

**Flex-Hones® produce a plateaued finish for fast ring seating and better oil retention for longer engine life.**

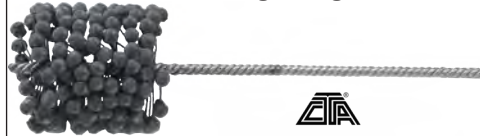

Part #	Size	Sale	Club
CTA1142	1"	\$36.88	<b>\$29.<sup>50</sup></b>
CTA1147	1-1/2"	\$47.44	<b>\$37.<sup>95</sup></b>
CTA1149	1-3/4"	\$48.13	<b>\$38.<sup>50</sup></b>
CTA1150	2"	\$50.00	<b>\$40.<sup>00</sup></b>
CTA1152	2-1/4"	\$53.13	<b>\$42.<sup>50</sup></b>
CTA1154	2-1/2"	\$58.18	<b>\$46.<sup>54</sup></b>
CTA1156	2-3/4"	\$65.63	<b>\$52.<sup>50</sup></b>
CTA1158	3"	\$72.44	<b>\$57.<sup>95</sup></b>
CTA2274	3-1/4"	\$73.13	<b>\$58.<sup>50</sup></b>
CTA2276	3-1/2"	\$79.38	<b>\$63.<sup>50</sup></b>
CTA2278	3-3/4"	\$84.38	<b>\$67.<sup>50</sup></b>
CTA2280	4-1/8"	\$88.13	<b>\$70.<sup>50</sup></b>
CTA2282	4-5/8"	\$99.94	<b>\$79.<sup>95</sup></b>
CTA2284	3" H.D.	\$102.44	<b>\$81.<sup>95</sup></b>
CTA2286	3-1/4" H.D.	\$106.88	<b>\$85.<sup>50</sup></b>
CTA2288	3-1/2" H.D.	\$109.94	<b>\$87.<sup>95</sup></b>
CTA2290	3-3/4" H.D.	\$114.69	<b>\$91.<sup>75</sup></b>
CTA2292	4" H.D.	\$123.44	<b>\$98.<sup>75</sup></b>
CTA2294	4-1/4" H.D.	\$131.19	<b>\$104.<sup>95</sup></b>
CTA2296	4-1/2" H.D.	\$139.38	<b>\$111.<sup>50</sup></b>
CTA2297	5" H.D.	\$162.44	<b>\$129.<sup>95</sup></b>
CTA2298	5-1/2" H.D.	\$178.69	<b>\$142.<sup>95</sup></b>
CTA2400	6" H.D.	\$194.38	<b>\$155.<sup>50</sup></b>
CTA2401	6-1/2" H.D.	\$211.19	<b>\$168.<sup>95</sup></b>
CTA2402	7" H.D.	\$229.38	<b>\$183.<sup>50</sup></b>
CTA2403	7-1/2" H.D.	\$249.94	<b>\$199.<sup>95</sup></b>
CTA2404	8" H.D.	\$262.44	<b>\$209.<sup>95</sup></b>

**DIESEL COMPRESSION**

DIESEL COMPRESSION ADAPTERS AVAILABLE FOR MOST CARS & TRUCKS



**MITMV5535 Diesel Compression Tester**  
 Cummins: 2.9L, 3.9L, 5.9L, 5.9L-24 valve  
 Navistar: 6.9L, 7.3L; VW: 1.9L  
 GM: 4.3L, 5.7L, 6.2L, 6.5L  
 Sale \$337.44 **Tool Club \$269.95**



**LANGCLT2PB Cylinder Leakage Tester**  
 Pinpoints the cause of low compression. Two gauges will monitor air input & compression. Supplements a compression tester.  
 Sale \$130.31 **Tool Club \$104.25**

**OTC5609**

**Cylinder Leakage Tester**  
 Dual 2.5" gauges. Long flex 24" 14mm hose. 10, 12, 18mm thread adapters. Detailed instruction chart.  
 Sale \$137.44 **Tool Club \$109.95**



**LIS20300**

**Vacuum Gauge & Fuel Pump Tester**  
 Sale \$36.56  
**Tool Club \$29.25**



**SY15300**

**EGT Sensor Sockets**  
 Designed to remove exhaust temperature sensors. 13, 14, & 17mm. Offset & inline sockets.  
 Sale \$174.38  
**Tool Club \$139.50**



**GASOLINE COMPRESSION**



**MITMV5532 Gasoline Compression Tester**  
 Includes: full set of adapters: 10, 12, 14 & 18mm, plus an air hold adapter for holding the valves up.  
 Sale \$187.44 **Tool Club \$149.95**

**LANGTU30PB Master Gasoline Compression Tester**

Set comes complete with all adapters, all lengths for 10, 12, 14 & 18mm threads. Quick disconnect & a separate small engine tester.  
 Sale \$169.06  
**Tool Club \$135.25**



**MITMV5530 Professional Compression Test Kit**  
 For dry and wet engine cylinder compression tests that detect ring or cylinder head problems, sticking valves & blown head gasket(s). Adapters for motorcycles, marine and small engines.  
 Sale \$115.31 **Tool Club \$92.25**

**LIS20250 Compression Tester**

Fits: 14mm, 14mm long & 18mm threads.  
 Sale \$52.50  
**Tool Club \$42.00**



**PRESSURE TESTERS**

**LANGTU16APB Transmission & Engine Oil Pressure Tester**  
 Features two gauges for accurate testing. Fits most domestic and imported cars.  
 Sale \$185.31  
**Tool Club \$148.25**



**KDT3343D Transmission & Engine Oil Pressure Tester**  
 Fits most domestic and imports.  
 Sale \$87.44  
**Tool Club \$69.95**



**LANGTU24APB Exhaust Back Pressure Gauge**  
 Three way tester will test at 3 places: Oxygen Sensor, Exhaust Pipes, Air Injection System.  
 Sale \$134.06  
**Tool Club \$107.25**



**LANGTU22APB Power Steering Pressure Tester**  
 Adapters will fit most domestic and imported cars.  
 Sale \$140.31 **Tool Club \$112.25**



**SURKP1500 DELUXE Fuel Line Replacement Kit**

Cost-Effective – Save up to 70% vs. OEM fuel lines  
 Easy-to-use – No special insertion tools required; reduces labor time  
 Complete Coverage – Works with Domestic & Foreign Vehicles  
 Safe – Nylon lines hold up to 200 PSI  
 Versatile – Safe for use with multiple fuel types including gas, ethanol and diesel  
 Includes 168 Pieces plus 75' Tubing!  
 Sale \$499.94 **Tool Club \$399.95**



**FUEL LOCK**



**CTA2493 Volvo Fuel Tank Lock Ring Wrench**  
 For all late model Volvos including S60, S80, V70, V70 XC, XC70 & XC90. 1/2" square drive.  
 Sale \$81.19 **Tool Club \$64.95**



**LT940 Fuel Tank Wrench**  
 Removes plastic fuel pump retaining rings. Increased length for wider applications.  
 Sale \$27.44 **Tool Club \$21.95**



**CTA1044 Toyota/Lexus Fuel Tank Lid Wrench**  
 Works on many Toyota & Lexus vehicles from 2004 & up. 9 slot design with 173mm OD & 143mm ID. 3/8" Dr.  
 Sale \$83.69 **Tool Club \$66.95**



**LIS62970 Fuel Tank Lock Ring Kit**  
 Channel design allows 2 interchangeable sets of legs to adjust to fit rings from 4" - 7-1/4". Works on many 2004 & newer vehicles including Ford, Chevrolet, Chrysler/Dodge, PT Cruiser, Dakota & Durango.  
 Sale \$75.63 **Tool Club \$60.50**



**LIS63000 Fuel Tank Lock Ring Tool**  
 Range: 4" to 7-1/4"  
 Sale \$50.63  
**Tool Club \$40.50**



**SY69800 Volvo Fuel Pump Socket**  
 For all late model Volvos.  
 Sale \$59.38  
**Tool Club \$47.50**



**AST78935 Universal Fuel Tank Lock Wrench**  
 7" size, 1/2" drive. Applications: GM/Chrysler/Dodge, Ford, BMW, Hyundai, Jaguar, Mercedes, Nissan, Subaru, Saab, Volvo & more!  
 Sale \$34.69 **Tool Club \$27.75**





**LANG**  
TOOLS

**LANGTU550**  
**Master Global Fuel Injection Test Kit**  
Covers all major domestic and foreign platforms from 1988 - present. Test gauge assembly disconnects from test hose and valve assembly for easier storage. Fuel line tee can accommodate 3/8", 1/4", & 5/16" hose sizes.  
Sale \$499.94 **Tool Club \$399.95**

**LANGTU470B**  
**Fuel Injection Cleaner**  
Two gauges to check vehicle fuel pressure and set cleaning pressure. Restores original spray pattern and cleans carbon.  
Sale \$288.69  
**Tool Club \$230.95**



**DIESEL FUEL  
PRESSURE TESTERS**



**LANGTU32**  
**Master Fuel System Test Kit - Cummins 5.9L**  
Compound pressure/vacuum gauge, fuel pressure test adapters, inlet restriction test adapters, and fuel volume test adapters. For Cummins Series B & ISB engines.  
Sale \$374.94 **Tool Club \$299.95**



**LANGTU32-2**  
**Basic Diesel Fuel Pressure Test Kit**  
100 PSI gauge assembly, 4' hose, pressure relief valve, and 6' clear PVC tube, 5 banjo bolt adapters, and repair kit. Used on single cylinder to V32 diesel engines.  
Sale \$237.44 **Tool Club \$189.95**

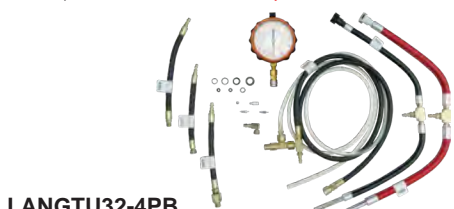

**LANGTU32-4PB**  
**Ford Power Stroke Diesel Fuel System Kit**  
1994 - present. Use adapters to test at fuel filter and fuel pump. Includes 100 PSI gauge, bleed off valve hose assembly, & all adapters necessary.  
Sale \$337.44 **Tool Club \$269.95**



**CTA3300**  
**Fuel Injection Pressure Tester**  
Checks PFI (Port-Fuel-Injected) and TBI (Throttle-Body-Injected) systems on most vehicles. Includes 3-1/2" gauge with dual calibrations (5-145 PSI / 25-1,000 kPa), 2-1/2" gauge with dual calibrations (0-15 PSI and 0-1.00 kg/cm<sup>2</sup>) and complete range of adapters and hose assemblies. MADE IN USA.  
Sale \$412.44 **Tool Club \$329.95**



**CTA3350**  
**Fuel Injection Pressure Tester**  
Kit for most domestic and Asian fuel injection systems, except GM TBI.  
Sale \$137.44  
**Tool Club \$109.95**



**AST7898**  
**Deluxe Noid Light & IAC Tester Set**  
Noid lights plus two GM IAC testers.  
Sale \$26.19 **Tool Club \$20.95**



**LANG71319**  
**Small Schrader Hose**  
Sale \$22.81 **Tool Club \$18.25**



**LANG71318**  
**Standard Schrader Hose**  
Sale \$19.19 **Tool Club \$15.35**



**NEW!**



**CTA8877**  
**VW/Audi Fuel Injector Puller/Remover**  
Fuel injector puller. Installation and removal of high pressure injectors. Installs combustion chamber seal. Services VW and Audi with direct injection FSI system.  
Sale \$152.19 **Tool Club \$121.75**



**NEW!**



**CTA7808**  
**Injector Puller Kit**  
Removes frozen or cracked injectors without removing the electrical part. Includes connectors M12 & M14.  
Sale \$384.38 **Tool Club \$307.50**

**COMBUSTION LEAK**

**UV560000**  
**Combustion Leak Tester**  
Dual chamber design for higher accuracy to eliminate false readings. Includes tester and fluid. UV560500 for replacement fluid.  
Sale \$77.86 **Tool Club \$62.29**



**LIS75500**  
**Combustion Leak Detector**  
Detects exhaust gases in radiator fluid for gasoline engines. Order #75730 for Diesel.  
Sale \$46.19 **Tool Club \$36.95**



**LIS75630**  
**Combustion Leak Indicating Fluid**  
Sale \$9.94 **Tool Club \$7.95**



**LIS75730**  
**Combustion Leak Indicating Fluid for Diesel**  
Sale \$9.94 **Tool Club \$7.95**

**OTC6768**  
**Ford 6.0L Glow Plug Removal Tool**  
For 2004 - 2009 Ford 6.0L diesel engines.  
Sale \$37.44 **Tool Club \$29.95**



**OTC6763**  
**Ford 6.0L High Pressure Oil Pump Adapters**  
For the high pressure oil pump which drives the injectors on the Ford 6.0L.  
Sale \$46.88 **Tool Club \$37.50**



**SY11400**  
**Ford Power Stroke 6.7L Diesel Injector Socket**  
17mm 12 point flare nut socket & deep crows foot allows for removal of various injector lines.  
Sale \$69.06 **Tool Club \$55.25**



**CTA7468**  
**4pc. Injection Line Wrench Set**  
2220X14 - 14mm  
2220X17 - 17mm  
2220X19 - 19mm  
5069 - 22mm  
1/2" Sq Dr. 12 pt "Bi-hex" wrenches. Includes case.  
Sale \$112.44 **Tool Club \$89.95**

**NEW!**



**SY13400**  
**Fuel Line Socket Set**  
Sizes: 14 & 17mm. 12pt. Application: BMW N54 / N63 / S63 2007-2013 Models.  
Sale \$45.63 **Tool Club \$36.50**

**NEW!**



**CTA7806**  
**Injector Seal Extraction Kit**  
Removes clogged or stuck diesel injector seals. Kit includes: (2) conical removers with double thread entry that services both passenger and light-duty utility vans & trucks.  
Sale \$268.69 **Tool Club \$214.95**

**NEW!**



## SENSOR TOOLS

### AST7801 7pc Sensor & Sending Unit Socket Set

Allows the removal of oil pressure sending units on late 1980 and mid 1990 GM vehicles.  
Sale \$78.69 **Tool Club \$62.95**



### KDT41720 8pc Sensor & Sending Socket Set

Designed for removal and installation of oxygen sensors, oil pressure sending units and vacuum switches.  
Sale \$87.44 **Tool Club \$69.95**



### WILW84007 Flex Head Oxygen Sensor Wrench

22mm (7/8) hex. Curved handle.  
Sale \$21.19 **Tool Club \$16.95**



### LIS12390 Dual Drive Oxygen Sensor Wrench

Both 1/2" & 3/8" openings for a breaker bar.  
Sale \$30.31 **Tool Club \$24.25**



### SY66750B Shielded Oxygen Sensor Wrench

Removes & replaces shielded oxygen sensors on Toyota, Lexus & Mazda.  
Sale \$38.69 **Tool Club \$30.95**



### SY93750B 2 Sided Offset Oxygen Sensor Wrench

2-1/8" offset. For foreign and domestic applications. 6 & 12 point design.  
Sale \$38.69 **Tool Club \$30.95**



### LIS12100 Oxygen Sensor Socket

Sale \$18.44 **Tool Club \$14.75**



### KDT3920D Sensor Socket

For removing oxygen sensors, vacuum, TVS, PVS, & vacuum switches.  
Sale \$21.19 **Tool Club \$16.95**



**CTA7850  
Ford Flow Sensor Socket - 19mm**  
3/8" Drive. Thin wall design  
Sale \$19.94 **Tool Club \$15.95**



**LIS12230  
Oxygen Sensor Thread Chaser**  
Stubby design for tight spaces.  
Sale \$6.88 **Tool Club \$5.50**



## BEARING & SEAL



**AST78410  
Adjustable Blind Inner Bearing Slide Hammer Puller**  
For bearings & bushings with 0.75 - 2.3" inside diameter or up to 2.0" when pulling from outside diameter. 2.5lb sliding hammer.  
Sale \$68.69 **Tool Club \$54.95**



**AST78415  
Locking Pliers Slide Hammer Puller**  
Universal puller for locking onto and hammering to remove everything from cotter pins to old seals and bushings  
Sale \$68.69 **Tool Club \$54.95**

**AST7824  
Bearing Driver**  
Sizes: 1.565" to 3.180"  
Sale \$67.50  
**Tool Club \$54.00**



**LIS12800  
Bearing & Seal Driver**  
Features an adapter for air hammers as well as for hand use. 11 drivers. Range: 1.56" to 3.2"  
Sale \$137.44  
**Tool Club \$109.95**



**LIS59400  
Pinion Bearing Driver**  
For inner & outer pinion races on 1/2 & 3/4 ton Dodge, Ford, and GM pickups. 8 drivers. Range: 2-11/16" - 4-1/2". Features: Air hammer adapter.  
Sale \$168.13  
**Tool Club \$134.50**



**LIS161850  
5pc Truck Hub Seal Installer Kit**  
Fits the most popular sizes for class 7 & 8 over the road trucks & trailers & some medium duty trucks.  
Sale \$274.94  
**Tool Club \$219.95**



**LIS61900  
H.D. Bearing Race & Seal Driver Set**  
Fits most Class 8 over the road trucks & trailers & some medium duty trucks. Sizes: 3-43/64", 4-7/8", 4-13/16", 5-1/2", 5-25/32", 6"  
Sale \$249.94  
**Tool Club \$199.95**



**TITAN  
TIT51362  
Blind Hole Puller**  
For pulling pilot bearings and other jobs requiring an internal pull. Sizes: 3/8" to 1-1/4"  
Sale \$181.88 **Tool Club \$145.50**



**OTC27794  
Custom-Made Driver Tools Basic Set**  
Have the proper size driver for nearly any automotive seal, bearing, or bushing installation job! Set includes two(2) Handle sizes & 41 discs, ranging from 1/2" to 3" diameter, in 1/16" increments. All discs are 1/2" thick. Plastic storage box & insert.  
Sale \$662.44 **Tool Club \$529.95**



**MAY62015  
4pc Bearing Race Punch Set**  
Remove bearings without damage. Oval tips. For all bearing races.  
Sale \$110.94 **Tool Club \$88.75**

## SEAL PULLERS

**LIS56750  
Seal Puller**  
Sale \$14.38  
**Tool Club \$11.50**



**LIS56650  
Adjustable Seal Puller**  
Head adjusts to five positions. It will reach in tight spaces.  
Sale \$20.94 **Tool Club \$16.75**



**AST9519  
3pc Seal & O-Ring Puller Set**  
Sizes: 4.6", 6" & 6.5". Quickly & easily removes O-Rings, grease & oil seals.  
Sale \$22.44 **Tool Club \$17.95**

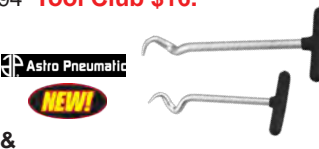

## SERPENTINE BELT



### KDT3680D 14pc GearWrench **GW** GEARWRENCH

**Flex Head Serpentine Belt Set**  
Includes long bar, special Gearwrench Ratcheting wrench, 3/8", 1/2", and 3/4" adapters, 7 sockets, and 3 crowsfoot.  
Sale \$90.00 **Tool Club \$72.00**



**KDT89000  
15pc Serpentine Belt Tool Kit**  
Includes 3/8" drive locking flex ratcheting wrench, long bar, 3 adapters, 7 6-point sockets & 3 crowsfoot sockets.  
Sale \$112.44 **Tool Club \$89.95**



**LIS59800  
Serpentine Belt Tool**  
Fits idler pulleys requiring 13, 14, 15, 16 and 18mm as well as 19mm hex.  
Comes in both 3/8" & 1/2" square drive sizes.  
Sale \$72.19 **Tool Club \$57.75**



**LIS59650 **NEW!****  
**11pc Ratcheting Serpentine Kit**  
Fits idler pulleys requiring 13, 14, 15, 16 and 18 mm as well as 19mm hex.  
Comes in both 3/8" & 1/2" square drive sizes.  
Sale \$115.63 **Tool Club \$92.50**



**LIS59670 **NEW!****  
**11pc Serpentine Belt Kit**  
Fits idler pulleys requiring 13, 14, 15, 16 and 18mm as well as 19mm hex.  
Comes in both 3/8" & 1/2" square drive sizes.  
Sale \$106.19 **Tool Club \$84.95**

**CTA3458  
BMW A/C Belt  
Installation Tool**  
Designed for use on BMW V8 N62 Vehicles.  
Specifically Crafted for BMW year 2004 to 2006 Models.  
Sale \$37.44 **Tool Club \$29.95**



**LIS59370  
Stretch Belt  
Remover / Installer**  
Magnetic faces hold the tool in place on the pulley.  
Sale \$25.94 **Tool Club \$20.75**



## HARMONIC BALANCER

**AST7846  
Harmonic  
Balancer Puller** **AP** Astro Pneumatic  
For harmonic balancers, crankshaft pulleys, steering wheels & gear pulleys.  
Sale \$65.63  
**Tool Club \$52.50**



**LIS45500  
Harmonic Balancer Puller**  
Helps stop damage to pulley & shaft. Designed to ease the operation of pulling the balancer pulley.  
Sale \$39.38 **Tool Club \$31.50**

**LIS53790  
Harmonic Balancer  
Installer Kit - 13 Adapters**  
Use to install harmonic balancers or drive pulleys that are pressed on one or two groove pulleys on the crankshaft. Good for Dodge Hemi, Generation III & IV GM motors, some Chrysler & some Ford.  
Sale \$206.19 **Tool Club \$164.95**



**CAL38800  
Harmonic Balancer Installer**  
Use to install harmonic balancers or drive pulleys that are pressed on one or two groove pulleys on the crankshaft.  
Sale \$66.88 **Tool Club \$53.50**

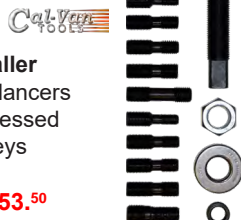

## PULLEY PULLERS



**KDT2897D **GW** GEARWRENCH**  
**Pulley Puller**  
For alternator and power steering pulleys, including Ford Quad 4.  
Sale \$89.38 **Tool Club \$71.50**

**LIS39000  
No Slip  
Pulley Puller**  
For most domestic vehicles.  
Works on traditional V-shaped & serpentine belt system pulleys.  
Sale \$82.44 **Tool Club \$65.95**



**AST7874  
Pulley Puller**  
For alternator, power steering and air pump.  
Sale \$37.44  
**Tool Club \$29.95**



**LIS54810  
Harmonic Balancer Puller Set**  
Kit includes a standard harmonic balancer puller, pulling screws, adapters for 3300 & 3800 GM V6 engines, & a harmonic damper pulley puller for Chrysler, GM, Mitsubishi, & Dodge, 3.6L V6 Chevrolet Camaro & Dodge 5.7L Hemi.  
Sale \$243.13 **Tool Club \$194.50**

**LIS51450  
Harmonic Damper  
Pulley Puller** **Rite**  
For GM, Chrysler & Mitsubishi.  
Sale \$111.88  
**Tool Club \$89.50**



**AST78450  
HD Harmonic  
Crank Pulley Puller**  
Use to crank pulley dampeners without female treaded holes. Heavy Duty Grade 9 Drive Bolt.  
Sale \$72.48  
**Tool Club \$57.98**



**CAL38000  
Ratcheting Harmonic  
Balancer Puller** **Cal-Van TOOLS**  
Remove harmonic balancers without the hassle of trying to start bolts or the frustration of positioning multi jointed puller legs.  
Sale \$81.19 **Tool Club \$64.95**



**CAL38710 **NEW!****  
**Ford EcoBoost Long Reach  
Harmonic Balancer Installer** **Cal-Van TOOLS**  
Nut and bearing sleeve assembly reduces friction while ensuring a proper fit.  
Sale \$41.19 **Tool Club \$32.95**



**SY60100A  
High Offset Damper Pulley Tool**  
4" long offset. For many 2004+ SUV's plus older Honda / Acura engines.  
Sale \$71.19  
**Tool Club \$56.95**



**TIT51700  
Crankshaft Pulley Holder**  
1992+.  
Sale \$33.69  
**Tool Club \$26.95**



**CTA4245**  
**CV Joint Puller**  
 1-7/8" 48mm wide opening.  
 Sale \$31.88  
**Tool Club \$25.50**



**WILW87024**  
**Alternator Pulley Service Kit**  
 Service late model foreign & domestic vehicles with either OWC or OAD alternator pulleys.  
 Sale \$99.94 **Tool Club \$79.95**



**LIS57650**  
**5pc Alternator Decoupler Tool Set**  
 Removal and installation of ADP (one way and overriding/freewheeling)  
 Sale \$40.31 **Tool Club \$32.25**



**OTC5940**  
**BMW Head Bolt Socket**  
 Works on M42 & M50 engines. Spring loaded tip will hold the bolt in place.  
 Sale \$37.44  
**Tool Club \$29.95**



**HEAD BOLT**

**VIMHB100**  
**Toyota Head Bolt Socket**  
 For Paseo and Tercel.  
 Sale \$18.69  
**Tool Club \$14.95**



**VIMV3452**  
**VW / Audi Head Bolt Socket**  
 Works on Polydrive head bolt.  
 Sale \$13.75  
**Tool Club \$11.00**



**CV BOOT PLIERS**

**LIS30600**  
**Offset Boot Clamp Pliers**  
 Crimps ear-type clamps in hard-to-reach areas.  
 Sale \$37.44 **Tool Club \$29.95**



**LIS30500**  
**CV Boot Clamp Pliers**  
 For Earless type clamps.  
 Sale \$29.06  
**Tool Club \$23.25**



**LIS30800**  
**CV Boot Clamp Pliers**  
 For Ear type clamps.  
 Sale \$37.44  
**Tool Club \$29.95**



**LIS30950**  
**CV Boot Clamp Pliers**  
 For band type clamps.  
 Sale \$14.69  
**Tool Club \$11.75**



**LIS60900**  
**Heater Core Backflush Tool**  
 Adjustable pressure industrial spray gun and stepped tip design for easy heater core flushing.  
 Sale \$45.63 **Tool Club \$36.50**



**OTC5025**  
**DEF Refractometer**  
 Calibrated scale with 32.5% to see if vehicle meets 2010 EPA regulations for diesel engines.  
 Sale \$144.38 **Tool Club \$115.50**

**LIS50210**  
**Gasket Separator**  
 For use on any application with a gasket seal, such as oil pans, transmission pans & differential coversl.  
 Sale \$30.63 **Tool Club \$24.50**



**LIS22500**  
**Thermostat Gasket Cleaner**  
 8-1/4" long. Use with a die grinder to quickly clean gasket surfaces in inaccessible applications.  
 Sale \$27.44 **Tool Club \$21.95**



**EZRHH1000**  
**Monster Double-Locking Hood Prop**  
 Safety button lock. Custom lock channel. Store in any tool box! The only prop to hold sport utility or mini-van gates 100% open.  
 Sale \$33.13 **Tool Club \$26.50**



**STEERING WHEEL**

**LIS45000**  
**Steering Wheel Puller**  
 Includes adapters for tilt and telescoping wheels.  
 Sale \$28.13 **Tool Club \$22.50**



**LIS57340**  
**Steering Wheel Lock Plate Tool**  
 Fits most domestic lock plates.  
 Sale \$29.38 **Tool Club \$23.50**



**KDT41620D**  
**Steering Wheel Puller Kit**  
 Includes all adapters for steering wheels & lockplates. Pulls crankshaft pulleys on Chrysler 2.2 & 2.5.  
 Sale \$90.63 **Tool Club \$72.50**



**TA66400**  
**Steering Wheel & Brake Pedal Holder**  
 Fits on virtually all cars and trucks.  
 Sale \$43.69  
**Tool Club \$34.95**



**LANG950**  
**Gasket Hole Punch Set**  
 10 punch sizes from 1/4" to 1"  
 Sale \$52.19  
**Tool Club \$41.75**



**LIS23800**  
**Flywheel Turner**  
 This will hold or turn most flywheels and flexplates.  
 Sale \$43.69  
**Tool Club \$34.95**



**LIS48700**  
**40" Throttle Pedal Depressor**  
 Holds throttles at a constant RPM.  
 Sale \$36.88 **Tool Club \$29.50**

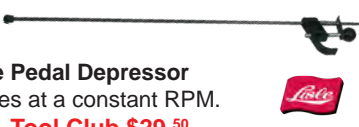

**LIS46170**  
**Hood Prop**  
 Extends from 20" to 48"  
 Includes extra foot.  
 Sale \$54.94 **Tool Club \$43.95**



**LIS52750**  
**Dual Stethoscope Kit**  
 Has a metal tip for mechanical sounds & a funnel for air sounds.  
 Sale \$33.69  
**Tool Club \$26.95**







**KDT41580D**  
**Fan Clutch Service Kit**  
 Includes: 22mm, 36mm, 40mm, 47mm, and 50mm wrenches. Includes universal pulley holder, small pin set & large pin set.  
 Sale \$162.44 **Tool Club \$129.<sup>95</sup>**



**CTAA886**  
**BMW Fan Clutch Wrench Kit**  
 One tool removes lock nuts on fan, while other tool holds the water pump pulley while loosening the radiator fan.  
 Sale \$48.44 **Tool Club \$38.<sup>75</sup>**



**SY61600**  
**Universal Fan Clutch Pulley Holding Tool**  
 Hooks onto the bolt of any water pump. Works on Chrysler, Ford, GM, Land Rover, Mazda, Audi, BMW, and VW applications.  
 Sale \$60.63 **Tool Club \$48.<sup>50</sup>**



**LIS42920**  
**Universal Fan Clutch Wrench Set**  
 Unique design fits virtually every application. Includes a universal holding wrench and universal turning wrench.  
 Sale \$104.94 **Tool Club \$83.<sup>95</sup>**



**SY10950**  
**Honda/Acura Serpentine Belt Tensioner Tool**  
 6 point, 19mm & 14mm for extreme tight spaces. Allows you to work on vehicle from the top.  
 Sale \$80.63 **Tool Club \$64.<sup>50</sup>**

**FAN CLUTCH**



**LIS44180**  
**Fan Clutch Spanner Wrench**  
 For GM, Jeep, & Dodge Trucks, Vans, and SUVs with pressed on water pump pulleys.  
 Sale \$54.94 **Tool Club \$43.<sup>95</sup>**



**SY62100**  
**32mm BMW Fan Clutch Wrench**  
 Fits the 3, 5, 7, and 8 series BMW.  
 Sale \$57.44 **Tool Club \$45.<sup>95</sup>**



**LIS43600**  
**Fan Clutch Wrench Set**  
 Unique wrench design. Double-sided spanner style will work on 36mm, 47mm & 1-7/8" sizes on many GM, Jeep and Dodge vehicles.  
 Sale \$81.19 **Tool Club \$64.<sup>95</sup>**



**SY15800**  
**Toyota "Top Access" Serpentine Belt Tensioner Wrench**  
 12 point, 14mm & 19mm for access to the tensioner from the top side of the engine.  
 Sale \$95.63 **Tool Club \$76.<sup>50</sup>**



**SY94170A**  
**Belt Installer for Serpentine/V-Belt/Timing Belt**  
 Works with all types of belts. Three pin design for more control of belt installation.  
 Sale \$21.88 **Tool Club \$17.<sup>50</sup>**



**LIS43300**  
**Pneumatic Fan Clutch Wrench Set**  
 Quickly removes & installs fan clutch when repairing the water pump or fan clutch. No holding wrench is necessary. Fits Ford, GM, Chrysler, & Jeep. Fits Ford 6.0L & 6.4L Powerstroke engines. Use with an air hammer.  
 Sale \$181.19 **Tool Club \$144.<sup>95</sup>**



**KDT3900**  
**Universal Pulley Holder**  
 Designed to trap & hold bolt-on pulleys by the mounting bolts. Fits Ford, GM, Dodge & Jeep engines. Includes small pin set 5mm x 8mm and large pin set.  
 Sale \$39.38 **Tool Club \$31.<sup>50</sup>**

**WATER PUMP**

**CTA8069**  
**Ford Water Pump Pulley Tool - 3.0L**  
 Removes & installs water pump pulley on 3.0L DOHC engines.  
 Sale \$98.13 **Tool Club \$78.<sup>50</sup>**



**LIS14440**  
**GM Northstar Water Pump Remover**  
 For GM Northstar 4.0L and 4.6L engines.  
 Sale \$31.88 **Tool Club \$25.<sup>50</sup>**



**LIS13800**  
**GM Ecotec Water Pump Sprocket Holder**  
 Sale \$44.06 **Tool Club \$35.<sup>25</sup>**



**SPANNER WRENCHES**



**CAL752**  
**Variable Pin Spanner Wrench**  
 Fits on pulleys that feature holes or slots, including crankshaft and camshaft pulleys. Adjustable: 1-1/4" up to 5". Fits: 3.5, 4, 4.5, 5, 6, 7 & 10mm Pins.  
 Sale \$71.56 **Tool Club \$57.<sup>25</sup>**

**WILW30781**  
**1" to 6" SAE Black Oxide Adjustable Face Pin Spanner Wrench**  
 Versatile 4mm pins  
 Sale \$15.94 **Tool Club \$12.<sup>75</sup>**

**WILW30784**  
**Adjustable Hook Wrench**  
 Fits 2" to 4-3/4"; 50 to 120mm.  
 Sale \$48.69 **Tool Club \$38.<sup>95</sup>**

**WILW30785**  
**Adjustable Hook Wrench**  
 Fits 4-1/2" to 6-1/4"; 114 to 160mm.  
 Sale \$64.06 **Tool Club \$51.<sup>25</sup>**

**CTA8605 Large**  
**Adjustable Gland Nut Wrench**  
 Fits 2" to 6"; 51 to 152mm  
 Sale \$59.94 **Tool Club \$47.<sup>95</sup>**

**OTC4791**  
**3/4" - 2" Spanner Wrench**  
 Chrome vanadium hardened steel wrench. 5" handle and slim strong hook.  
 Sale \$34.99 **Tool Club \$27.<sup>99</sup>**

**OTC4792**  
**2" - 4-3/4" Spanner Wrench**  
 Chrome vanadium hardened steel wrench. 9" handle and slim strong hook.  
 Sale \$56.88 **Tool Club \$45.<sup>50</sup>**

**CTA8600**  
**Adjustable Gland Nut Wrench**  
 Fits 1" to 3-3/4"; 25 to 95mm.  
 Sale \$37.44 **Tool Club \$29.<sup>95</sup>**



## SPECIALTY PULLERS

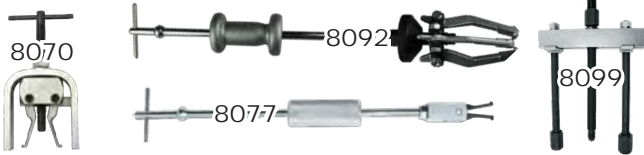

Part #	Description	Sale	Club
CTA8070	Screw Type Bearing Puller	\$59.38	<b>\$47.50</b>
CTA8077	Slide Hammer Bearing Puller	\$75.63	<b>\$60.50</b>
CTA8092	Slide Hammer Puller	\$99.06	<b>\$79.25</b>
CTA8099	Push Puller	\$91.56	<b>\$73.25</b>

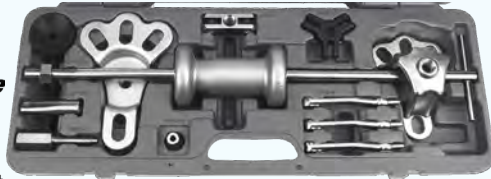

**WILW89725**

### Slide Hammer Puller Set

Slide hammer with multiple attachments: 2/3 Jaw internal and external pullers, 2 rear axle pullers, locking plier adapter, puller hook & dent puller. Sale \$143.69 **Tool Club \$114.95**



**SUN3911**

### Professional Slide Hammer Puller Set

Includes: 5lb HD slide hammer, dent puller, 8 function internal or external 2-jaw/3-jaw puller, seal puller hook, rear axle puller plate, and metal box. Sale \$129.94 **Tool Club \$103.95**

## TITAN

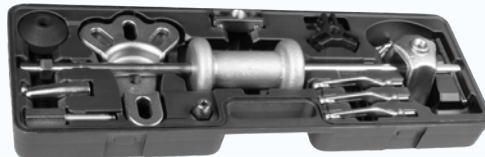

**TIT51310**

### Slide Hammer Puller Set

Includes: 5lb slide hammer, front hub puller, rear axle puller, external 3 jaw puller, internal 3 jaw puller, external 2 jaw puller, internal 2 jaw puller, puller hook, dent puller and grip wrench. Sale \$137.44 **Tool Club \$109.95**



**CTA8490**

### Thin Jaw Puller Set

For pulling jobs in tight spaces. Includes 3 pairs of different length arms. 4", 8", & 10" long arms with hardened thin-jaw attachments. Sale \$206.19 **Tool Club \$164.95**



**OTC1183**

### Bearing Splitter Set

Features: 4 bearing splitters up to 9", plus a pulley puller with a range up to 5-7/8". Sale \$624.94 **Tool Club \$499.95**

## 2 JAW PULLERS



Part #	Spread	Reach	Sale	Club
OTC1020	3-1/4"	2-1/8"	\$55.31	<b>\$44.25</b>
OTC1022	4"	3-1/4"	\$60.31	<b>\$48.25</b>
CTA8000B	4"	3-1/2"	\$39.94	<b>\$31.95</b>
OTC1028	4-1/2"	3-1/2"	\$116.88	<b>\$93.50</b>
OTC1025	6"	3-1/4"	\$78.69	<b>\$62.95</b>
OTC1031	6"	3-1/4"	\$119.38	<b>\$95.50</b>
CTA8005B	6"	3-1/2"	\$54.94	<b>\$43.95</b>
CTA8010	7"	5-1/2"	\$64.94	<b>\$51.95</b>
OTC1036	9-1/2"	8-3/4"	\$111.88	<b>\$89.50</b>
CTA8020	10"	9"	\$108.44	<b>\$86.75</b>
CTA8030	15"	5"	\$178.13	<b>\$142.50</b>

## 3 JAW PULLERS



GEARWRENCH



Part #	Spread	Reach	Sale	Club
OTC1021	3-1/4"	2-1/8"	\$65.63	<b>\$52.50</b>
KDT3624D	3-1/4"	2-5/8"	\$82.44	<b>\$65.95</b>
CTA8035B	4"	3-1/2"	\$44.69	<b>\$35.75</b>
OTC1023	4-3/4"	3-1/4"	\$65.63	<b>\$52.50</b>
OTC1026	7"	3-1/4"	\$87.44	<b>\$69.95</b>
CTA8040B	7"	3-1/2"	\$61.88	<b>\$49.50</b>
OTC1027	7-1/2"	5-1/2"	\$90.31	<b>\$72.25</b>
CTA8045B	8"	5-1/2"	\$80.94	<b>\$64.75</b>
CTA8050B	10"	5-1/2"	\$131.19	<b>\$104.95</b>
OTC1037	10-1/2"	5"	\$162.44	<b>\$129.95</b>
OTC1038	11"	8-3/4"	\$141.88	<b>\$113.50</b>
CTA8057	14"	11"	\$187.44	<b>\$149.95</b>

## BEARING SPLITTERS



Part #	Range	Sale	Club
OTC1122	1/8" - 2"	\$73.13	<b>\$58.50</b>
CTA8060	0 - 2-1/4"	\$41.19	<b>\$32.95</b>
CTA8065	0 - 4-1/4"	\$85.63	<b>\$68.50</b>
OTC1123	1/2" - 4-5/8"	\$121.88	<b>\$97.50</b>
OTC1124	1/2" - 5-3/4"	\$249.94	<b>\$199.95</b>
CTA8150	0 - 6"	\$174.94	<b>\$139.95</b>
CTA8155	0 - 8"	\$281.19	<b>\$224.95</b>
OTC1130	1/2" - 9"	\$287.44	<b>\$229.95</b>

## INNER TIE ROD



**NEW!**  
Falle  
MADE IN USA

**LIS58100**  
**12pc Inner Tie Rod Tool Set**  
Improved socket design to work on longer applications. The long socket slips over tie rod end and crows foot engages on socket for easy removal and installation of tie rods with inaccessible wrench flats. Includes 12 crowsfeet, sizes 1-3/16", 1-1/4", 1-3/8", 1-1/2", 1-5/16", 1-7/16", 29mm, 32.5mm, 33.6mm, 38.4mm, 40mm and 42mm, to fit many cars, trucks and SUVs.  
Sale \$187.44 **Tool Club \$149.95**

**MAY29912**  
**4pc Interchangeable Inner Tie Rod Tool Kit**

Includes three (3) interchangeable cages that fit tie rods ranging from 28-45mm.  
Sale \$274.94  
**Tool Club \$219.95**

**LIS45750**  
**6pc Inner Tie Rod Set**  
Sizes 33.6mm, 1-3/16", 1-1/4", 1-5/16", 1-7/16", & 1-1/2".  
Sale \$99.94  
**Tool Club \$79.95**

**CTA7878**  
**Sway Bar Link Parrot Nose Pliers**

Adjustable. Holds & removes sway bar link. Clamps & grips rusted or stripped nuts, pipes, screws & more.  
Sale \$41.88 **Tool Club \$33.50**

**CTA4014**  
**Inner Tie Rod Tool**

Removes inner tie rods without removing outer tie rods.  
Sale \$28.13 **Tool Club \$22.50**

**OTC** **NEW!**

**OTC5068**  
**Truck Tie Rod Socket**

Designed to withstand the force of a 3/4" drive impact wrench. Works on inner and outer tie rod ends on 12,000 to 16,000 lb truck axles. This rugged socket makes truck tie-rod end removal quick and simple.  
Sale \$199.94 **Tool Club \$159.95**

## EXHAUST HOSE

No couplers are needed. Hoses will thread into each other.



Part #	Hose Size	Sale	Club
CRUFLT250	2-1/2"	\$131.19	<b>\$104.95</b>
CRUFLT300	3"	\$157.44	<b>\$125.95</b>
CRUFLT400	4"	\$236.19	<b>\$188.95</b>
CRUACT500	5"	\$320.94	<b>\$256.75</b>



**GT**  
CHESAPEAKE TUBING CO.

**CRUDSS30**  
**3" Complete Exhaust Service Station**

Includes (3) 3" exhaust hoses, (2) 4" sections, (1) 6' section, splicer, tailpipe, and Y adapters.  
Sale \$327.81 **Tool Club \$262.25**

## TAILPIPE ADAPTERS



Part #	Fits Hose	Sale	Club
CRUF300	2.5" & 3"	\$39.06	<b>\$31.25</b>
CRUF350	3" & 4"	\$59.06	<b>\$47.25</b>
CRUF400	4"	\$78.69	<b>\$62.95</b>

## ACCESSORIES



**GT**  
CHESAPEAKE TUBING CO.

Part #	Pipe Size	Sale	Club
CRUADF30	3" Door Port	\$52.44	<b>\$41.95</b>
CRUADF40	4" Door Port	\$70.31	<b>\$56.25</b>
CRURY25	2.5" Y Adapter	\$44.38	<b>\$35.50</b>
CRURY30	3" Y Adapter	\$47.19	<b>\$37.75</b>

## SLACK ADJUSTMENT

**LANG**  
TOOLS

**LANG8569**  
**9/16" XL Automatic Slack Adjuster**  
For trucks equipped with Bendix. Extra deep.  
Sale \$49.69 **Tool Club \$39.75**

**LANG7578**  
**7/16" XL Slack Adjuster Wrench**  
For trucks equipped with Haldex. Extra deep.  
Sale \$39.69 **Tool Club \$31.75**

**LANG4651**  
**Automatic Slack Adjuster Release Tool & Wrench**  
Fork end tool to release the tensioner button and 5/16" double square reversible wrench.  
Sale \$56.25 **Tool Club \$45.00**

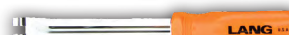

Falle

MADE IN USA



**LIS17350**  
**Pipe Stretcher Kit**  
Use with an impact wrench to expand exhaust pipes from 1-5/8" to 4-1/4".  
Sale \$268.69 **Tool Club \$214.95**

**LANGTU24APB**  
**3-Way Exhaust Back Pressure Kit**

Tests thru Oxygen Sensor, Exhaust Pipes & Air Injection System. Includes 6ft. hose and special gauge.  
Sale \$134.06  
**Tool Club \$107.25**



**LIS32500**  
**Tailpipe Expander**  
Range 1-5/8" to 2-7/16"  
Sale \$51.88 **Tool Club \$41.50**



**KDT2031DD**  
**Tailpipe Cutter**  
Cuts pipes 3/4" to 3"  
Sale \$68.69 **Tool Club \$54.95**



**LIS38350**  
**Exhaust Removal Pliers**  
Separates hanger brackets from rubber supports.  
Sale \$29.94 **Tool Club \$23.95**



**LIS32000** Pipe End Shaper  
Rounds crushed pipes.  
Sale \$49.94 **Tool Club \$39.95**



## DUAL PIPE ADAPTERS



Part #	Pipe Size	Sale	Club
CRUF475	2"	\$52.44	<b>\$41.95</b>
CRUF575	3"	\$65.31	<b>\$52.25</b>

MADE IN USA **Ken-Tool** **NEW!**

**KEN33210**  
**4pc Slack Adjuster Set**  
Includes Automatic Slack Adjuster Set (Meritor), 7/16" Haldex® Slack Adjuster Tool and 9/16" Bendix® Slack Adjuster Tool.  
Sale \$162.44 **Tool Club \$129.95**



**KEN33200**  
**Automatic Slack Adjuster Release Tool & Wrench**  
Fork end tool to release the tensioner button and 5/16" double square reversible wrench.  
Sale \$78.69 **Tool Club \$62.95**



# BODY HAMMER



## TA89470 9pc Body Repair Kit

Universal, toe, & heel dolly. Chisel, bumping, & door skin hammers.

General purpose and slapping spoons.  
Sale \$212.44 **Tool Club \$169.95**



## TA89360 5pc Body Forming Punch Set

Great for low clearance and tight areas where regular hammers do not fit. Round body, square body, bumping body, offset bumping body, & radial chisel.

Sale \$174.94 **Tool Club \$139.95**



## WILM7007 7pc Body Kit

Comes in case.

Use on flat & curved surfaces.  
Sale \$55.63 **Tool Club \$44.50**



## LIS65800 Door Adjuster

Adjusts doors with bolted or welded hinges. Includes 2 headed pin adapter for large and small latches. Handle creates extra leverage.

Sale \$65.63 **Tool Club \$52.50**



# COME-A-LONGS



LIFETIME WARRANTY

## APP72A 2 Ton, 6' Lift - USA Made

Sale \$91.19 **Tool Club \$72.95**



## APP18600 2 Ton, 6' Lift

New 25 year Warranty

Sale \$60.63 **Tool Club \$48.50**

## APP18650 4 Ton, 6' Lift

New 25 year Warranty

Sale \$106.19 **Tool Club \$84.95**



## TIT15084 7pc Autobody Hammer Set

Bumping, Pick & Finish, Reverse Curve, Utility, Double End, Shrinking and Curve Hammers.

Sale \$62.44 **Tool Club \$49.95**



## DFAH714 3pc Aluminum Hammer Set

Pick & finishing hammer, curved pein & finishing hammer, and standard bumping hammer.

Sale \$212.44 **Tool Club \$169.95**



## TA89900 2-3/4" x 8"

Sanding Board

Sale \$24.94

**Tool Club \$19.95**



## TA89800 5" Sanding Block

Sale \$8.69

**Tool Club \$6.95**



## TA89810 9" Sanding Block

Sale \$14.38

**Tool Club \$11.50**



## MOTJO20014 2.0mm Draw Pins for Welding Stud Gun (500 Pins)

Sale \$21.88 **Tool Club \$17.50**



## MOTJO1500 Magna-Spot 1500 Prof. Stud Welder Kit

For professional collision repair technician. Includes: Magna-Spot 1500 Gun, H.D. Slide Hammer, Molded Case, 3 Electrodes, 500 2.0 mm Draw Pins & 150 Rivets.

Sale \$412.44 **Tool Club \$329.95**



## MOTJO1550 Magna-Spot 1550 Deluxe Kit

Includes: Magna Spot 1550 Gun, H.D. Slide Hammer, Blow molded case, 3 Electrodes, 250 2mm drawpins, 250 2.5mm pins, 50 rivets, 5yr. Warranty, Magna Clamp & Magna T-Puller.

Sale \$562.44 **Tool Club \$449.95**



## MOTJO20015 2.5mm Draw Pins for Welding Stud Gun (500 Pins)

Sale \$23.13 **Tool Club \$18.50**



## EPHY'S SELLS THE FULL MOCLAMP™ BODY TOOLS LINE

Call for a free catalog or price quote.



Part #	Type	Sale	Club
MCL0100	"B" Clamp	\$183.13	\$146.50
MCL0200	"C" Clamp	\$208.69	\$166.95
MCL0205	Dyna-Mo "C" Clamp	\$150.94	\$120.75
MCL0300	"JR" Clamp	\$225.31	\$180.25
MCL0400	"W" Clamp	\$432.81	\$346.25
MCL5800	"G" Clamp	\$360.94	\$288.75
MCL0405	"W" Clamp	\$180.44	\$144.35
MCL0307	Dyna-Mo 90° Corner Clamp	\$198.13	\$158.50
MCL0680	Big Mouth Clamp	\$249.38	\$199.50
MCL0800	Tac-N-Pull Set w/ Plates	\$162.94	\$130.35
MCL0805	Tac-N-Pull Plate Kit	\$90.94	\$72.75
MCL4020	4 Way Pull Clamp	\$382.50	\$306.00
MCL1000	Handy Hook	\$90.94	\$72.75
MCL1100	Handy Link	\$99.69	\$79.75
MCL1300	8" Sill Hook	\$161.19	\$128.95
MCL1800	Hook Tie-Down for Track System	\$107.50	\$86.00
MCL4021	Frame Rack Dyna-Mo #1	\$346.56	\$277.25
MCL2400	3MA Strut Multi-Adapter Plate	\$620.63	\$496.50

Part #	Size	Sale	Club
MCL6006	6' Chain	\$132.81	\$106.25
MCL6008	8' Chain	\$154.06	\$123.25
MCL6009	9' Chain	\$155.31	\$124.25
MCL6012	12' Chain	\$206.19	\$164.95
MCL6013	12' Chain w/ Alloy Slip Hook	\$213.75	\$171.00
MCL6325	Tie Down Hook Cluster	\$187.81	\$150.25
MCL1150	Chain Spread Bar	\$121.88	\$97.50
MCL6317	J Hook w/ 3/8" Chain	\$63.44	\$50.75



## 3/8" CHAIN

- Special proof coil chains are made specifically for body work.
- MCL6006, MCL6008, MCL6009, & MCL6012.
- Includes clevis grab hook.



**TA81100**  
**10lb Slugger In A Box**  
 14 parts in a metal box.  
 Sale \$287.44  
**Tool Club \$229.95**



**TA81000**  
**10lb Slugger On A Board**  
 The most complete set available. 16 parts total.  
 Sale \$287.44  
**Tool Club \$229.95**



**TA80000**  
**10lb Economy Slugger Set**  
 A basic set for the most popular Slugger hooks supplied in a carton without board or metal box.  
 Sale \$187.44 **Tool Club \$149.95**



**TA81200**  
**5lb Slap Hammer Kit**  
 Includes a hook & screw.  
 Sale \$81.88 **Tool Club \$65.50**



**TA81500**  
**3lb Slap Hammer Kit**  
 Includes hook, right angle bar and screw.  
 Sale \$58.69 **Tool Club \$46.95**



**TA81400**  
**3lb Slap Hammer Economy**  
 Sale \$49.94 **Tool Club \$39.95**



**CTA1012**  
**Mini Bulb Remover/Installer**  
 Scissor design for easy handling. For all types of bulbs. Cup-type ends create circular gripping area.  
 Sale \$17.44 **Tool Club \$13.95**



**LIS35300**  
**V-Groove Clip Remover**  
 Narrow tip with V-Groove for removing plastic clips used on upholstery, door panels, radiator shrouds, fender liners and weather stripping. The tool is equipped with a sliding urethane bumper for use when extra leverage is necessary. Also use the bumper to protect the vehicle surface.  
 Sale \$14.38 **Tool Club \$11.50**



**ASTRO Pneumatic**  
**AST4524**  
**11pc Fastener & Molding Removal Set**  
 For use on internal & external vehicle molding and trim fasteners. Plastic construction of tools prevents scratching and damage to vehicle paint, leather, chrome, etc.  
 Sale \$26.19 **Tool Club \$20.95**



**LIS35350**  
**Door Panel Remover**  
 Bent handle design for tight spaces.  
 Sale \$17.44 **Tool Club \$13.95**



**CAL113**  
**5pc Trim & Panel Clip Tool Set**  
 Includes 5 different offsets with a range of three (3) spreads: 5mm, 7.5mm & 11mm. Ideal for plastic fasteners, plastic clips, upholstery or door panels. High-polish chrome finish & rubberized handles for additional grip.  
 Sale \$44.94 **Tool Club \$35.95**



**LIS81950**  
**Molding Strip Tool**  
 3" wide. Sharp edge allows easy under door moldings and emblems.  
 Sale \$16.88 **Tool Club \$13.50**



**KDT3729**  
**Push Pin Plier**  
 Removes the plastic push pins with center locking pin. No damage to pin.  
 Sale \$41.19 **Tool Club \$32.95**



**KDT41840D**  
**2pc Push Pin Plier Set**  
 Straight and offset pliers  
 Sale \$62.50 **Tool Club \$50.00**

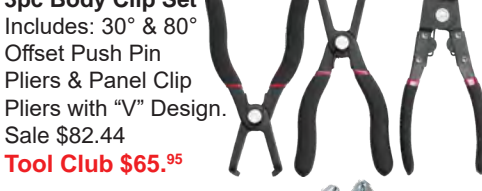

**KDT41850**  
**3pc Body Clip Set**  
 Includes: 30° & 80° Offset Push Pin Pliers & Panel Clip Pliers with "V" Design.  
 Sale \$82.44 **Tool Club \$65.95**



**KDT3702D**  
**2pc Hog Ring Plier Set**  
 Sale \$63.13 **Tool Club \$50.50**



**TITAN**  
**TIT15048**  
**6pc Multi Wedge Trim Panel Tool**  
 Sale \$15.63 **Tool Club \$12.50**



**ASTRO Pneumatic**  
**AST4505**  
**5pc Fastener & Molding Tool Set**  
 Variety of molding and trim fasteners. Plastic tools will protect finishes.  
 Sale \$13.69 **Tool Club \$10.95**

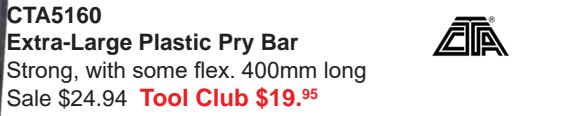

**CTA5160**  
**Extra-Large Plastic Pry Bar**  
 Strong, with some flex. 400mm long  
 Sale \$24.94 **Tool Club \$19.95**



**LIS35400**  
**Door Upholstery Remover**  
 Sale \$12.44 **Tool Club \$9.95**



**LIS35260**  
**Plastic Fastener Remover**  
 Sale \$15.63 **Tool Club \$12.50**



**TA87810**  
**Upholstery Clip Remover**  
 Sale \$12.44 **Tool Club \$9.95**



**WILW5259**  
**240pc Push Pin Retainer & Tool**  
 Assortment of Push Retainers for Ford, GM, Chrysler, Toyota, Honda, Nissan and more. For door trim, radiator shield yoke, fender, bumper & splash shields.  
 Sale \$21.19 **Tool Club \$16.95**

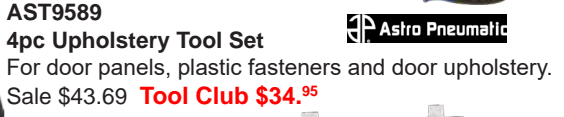

**ASTRO Pneumatic**  
**AST9589**  
**4pc Upholstery Tool Set**  
 For door panels, plastic fasteners and door upholstery.  
 Sale \$43.69 **Tool Club \$34.95**



**TITAN**  
**TIT85520**  
**240pc Universal Push Pin Retainer Kit & Removal Tool**  
 For door trim, fenders, bumpers, radiator shields, splash guards & more!  
 Sale \$24.94 **Tool Club \$19.95**



**ASTRO Pneumatic**  
**AST9581**  
**Precision Panel Clip Pliers**  
 For accessing & removal of difficult flush fasteners & clips. Rounded shoulder to help pry fasteners up. Notched jaw to help prevent snipping off plastic fastener heads.  
 Sale \$15.63 **Tool Club \$12.50**



**AFF819SD**  
**20 Ton Hydraulic Body & Frame Repair Kit**  
 Extra capacity for the toughest jobs. Contains all the tools necessary for pushing, spreading, and pressing of vehicle body panels, parts and assemblies. Auto air bleed pump eliminates the need to bleed the system prior to use. Dual piston pump for faster lifting speeds. Double braided hydraulic hose for increased durability & resistance to cracks & abrasions. Includes 5' hydraulic hose, 20 ton hydraulic ram & 20,000 PSI Hydraulic Hand Pump.  
 Sale \$1,499.94 **Tool Club \$1,199.95**

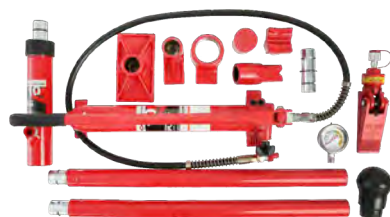

**AFF817SD**  
**10 Ton Body & Frame Repair Kit**  
 Contains all the tools necessary for pushing, spreading & pressing of vehicle body panels, parts and assemblies. Includes 5' Hydraulic Hose, 10 Ton Hydraulic Ram, 10 Ton Hydraulic Hand Pump & 1/2 Ton Spreader Ram.  
 Sale \$624.94 **Tool Club \$499.95**



**AFF58100**  
**Viking 10 Ton Body & Frame Repair Kit**  
 Set includes: 58044 - 5' Hydraulic Hose  
 58101 - 10 Ton Hydraulic Ram  
 58102 - 10,000 PSI Hydraulic Hand Pump  
 58103 - 1/2 Ton Spreader Ram  
 Sale \$474.94 **Tool Club \$379.95**



**AFF58040**  
**Viking 4 Ton Body & Frame Repair Kit**  
 Auto air bleed pump eliminates the need to bleed the system prior to use. Attachments are interchangeable with other body & frame kits. Set includes 5' Hydraulic Hose, 4 Ton Hydraulic Ram, 8000 PSI Hydraulic Hand Pump and 1/2 Ton Spreader Ram.  
 Sale \$362.44 **Tool Club \$289.95**

**PORTO POWERS**

**THA66040**  
**4 Ton Collision Repair Kit**  
 8,200 PSI pump with 6' hose, ram with 4-3/4" stroke, 3-1/4", 5", 8-1/2", 16-1/2" and 19-1/2" extension tubes, set of attachments and case.  
 Sale \$337.44 **Tool Club \$269.95**



**THA66100**  
**10 Ton Collision Repair Kit**  
 9,100 PSI pump with 6' hose, ram with 6" stroke, 4-5/16", 10", 18" & 26-3/4" extension tubes, set of attachments & carrying case with wheels.  
 Sale \$487.44 **Tool Club \$389.95**

**BH65114**  
**4 Ton Porto Power**  
 Complete with 8,000PSI capacity pump with overload protection, hose, ram, 3", 6", 8-1/2", 16-1/2", & 19-1/2" extensions and set of attachments.  
 Sale \$437.44 **Tool Club \$349.95**



**BH65115**  
**10 Ton PortoPower**  
 Complete with 10,000 PSI pump, 6ft. hose with coupler, 10 ton ram, 4", 10", 18", & 27" Extension tubes, 1/2 ton spreader & a set of attachments.  
 Sale \$662.44 **Tool Club \$529.95**

**Blackhawk Automotive**

**BEST UNIT!**

**SHOP VACUUMS**



**SVC5872911**  
**5 Gallon 6.0 Peak HP Portable Wet / Dry Vacuum**  
 This vacuum works great to clean wet or dry messes in your garage, workshop or basement. Attach the hose to the rear blower port to blow dirt out of those hard to reach places. Limited Lifetime Warranty.  
 Sale \$237.44 **Tool Club \$189.95**

**SVC9627106**  
**12 Gallon 5.5 Peak HP Contractor Series Wet / Dry Vacuum with SVX2 Motor Technology**  
 12-foot by 1.5-inch Diameter Lock-On® Hose, Two 1.5-inch Diameter Extension Wands, 14-inch Wet/Dry Floor Nozzle, 16-inch Crevice Tool, Claw Utility Nozzle, Adaptor, Tool Storage Basket  
 Sale \$287.44 **Tool Club \$229.95**



**SVC9627306**  
**18 Gallon 6.5 Peak HP Contractor Series Wet / Dry Vacuum with SVX2 Motor Technology**  
 Works great for job site cleanup, workshops, garages, basements. 1 Year Industrial Warranty.  
 Sale \$334.94 **Tool Club \$267.95**

**SVC9627806**  
**16 Gallon 6.5 Peak HP Stainless Steel Contractor Series Wet / Dry Vacuum with SVX2 Motor Technology**  
 12-foot by 1.50-inch Diameters Lock-On® Hose, Two 1.50-inch Diameter Metal Extension Wands, 14-inch Metal Nozzle, 14-inch Brush Insert, 14-inch Squeegee Insert, Tool Storage Basket. 1 Year Industrial Warranty.  
 Sale \$599.94 **Tool Club \$479.95**

**PUMPS**

**BH65580**  
3/8" Complete Coupler Set  
Sale \$63.13 **Tool Club \$50.50**



**BH65581**  
3/8" Hose Half Coupler  
Sale \$26.88 **Tool Club \$21.50**

**BH65582**  
3/8" Ram Half Coupler  
Sale \$39.19 **Tool Club \$31.35**

**BH65291**  
1/4" ID - 6ft Hose w/ Male Coupler 1/4" NPTF  
Sale \$62.44  
**Tool Club \$49.95**



**BH65590**  
3/8" ID - 6ft Hose w/ Male Coupler 3/8" NPTF  
Sale \$124.94  
**Tool Club \$99.95**



**THA66103**  
**10,000 PSI Air Pump**  
Reservoir capacity: 103 in<sup>3</sup>  
Usable oil volume: 97.6 in<sup>3</sup>  
Input air pressure: 90-175 PSI  
Sale \$337.44 **Tool Club \$269.95**



**OTC**   
**OTC4020**  
**Air Operated Hydraulic Foot Pump**  
Delivers up to 10,000 PSI.  
Two-stage release mechanism.  
Sale \$962.44 **Tool Club \$769.95**



**OTC2510A**  
**Air Hydraulic Pump**  
10,000 PSI.  
Internal relief valve.  
Foot pedal control.  
Sale \$499.94  
**Tool Club \$399.95**



**BH65425**  
**Air Operated Hydraulic Pump**  
Lightweight aluminum.  
Sale \$437.44  
**Tool Club \$349.95**



**BH65426**  
**Air Operated Foot Pump**  
10,000 PSI.  
Input: 110-175 PSI.  
Mount plate included.  
Sale \$549.94  
**Tool Club \$439.95**



**BH93075**  
**Anchor Pot**  
Designed with heavy-duty protective ring at top which prevents chipping of concrete. 3-1/8" diameter.  
Sale \$99.94 **Tool Club \$79.95**



**JAC859**  
**10 Ton Auto Body Frame Repair Straightener with 1.2 Ton Crane, Swivel Post, 2 Air Hydraulic Pumps**  
1 - Frame Assembly  
1 - Multi-Position Anchor Post  
1 - 10 Ton 6" Stroke Ram  
1 - Manual Pump  
2 - Pull Rings  
2 - Pull Clamps  
2 - 6 ft. Chains with Hooks  
2 - Support Stand  
1 - Cross-Tube  
2 - Underbody Support Clamps  
**CALL FOR BEST PRICE**



**BH65454**  
**5 Ton Pull Ram with Hooks**  
Range: 11.96" - 17.48". 5.55" stroke.  
Accepts 3/8" chain links.  
Sale \$499.94 **Tool Club \$399.95**



**AFF80409**  
**10 Ton Pull Ram**  
Claw hooks on each end.  
Sale \$212.44 **Tool Club \$169.95**



**BH65407**  
**10 Ton Pump, Hose & Ram Set**  
Ram has 10" stroke.  
Rugged construction.  
Sale \$999.94  
**Tool Club \$799.95**



**BH65139**  
**5 Ton Flat Ram Kit**  
Includes 4 stackable extensions.  
Range 1.26" to 4.9".  
Sale \$212.44  
**Tool Club \$169.95**



**RAMS**

**OTC4105A**  
**10 Ton Ram w/ Half Coupler**  
10-1/8" stroke.  
High strength.  
Sale \$724.94  
**Tool Club \$579.95**



**BH65452**  
**10 Ton Porto Power Ram**  
10" stroke.  
High strength alloy steel.  
HD return springs.  
Sale \$362.44  
**Tool Club \$289.95**



**BH65444**  
**10 Ton Threaded Ram 10" Stroke**  
Range: 15.63" - 25.75".  
High strength alloy steel.  
Sale \$412.44  
**Tool Club \$329.95**



**Blackhawk Automotive**

**BH93601B**  
**10 Ton Pulling Post**  
Use with common pot patterns or chainless anchor system. Longer/wide base for stability. Safety tie-down brackets. Utilizes 10" ram for longer pulls.  
Sale \$3,249.94 **Tool Club \$2,599.95**



**MCL3060**  
**Mo-Hole T-Top Tie Down for New Floors**  
The pot for new construction when you really are going to be making hard pulls. Two 3" rebar legs bury themselves below the bottom of the pot for a secure anchor.  
Sale \$212.44 **Tool Club \$169.95**



**OTC4175**  
**30 Ton Ram/Pump Set**  
47.15 lb. 10.3 x 14.8 x 24.8 inches.  
**CALL FOR BEST PRICE**



**JAC852B**  
**10 Ton Auto Body Frame Straightener with 1.2 Ton Crane and Swivel Post**  
1 - Frame Assembly  
1 - Multi-Position Anchor Post  
2 - 10 Ton 6" Stroke Ram  
2 - Air Hydraulic Pumps  
2 - Pull Rings  
2 - Pull Clamps  
2 - 6 ft. Chains with Hooks  
2 - Support Stand  
1 - Cross-Tube  
2 - Underbody Support Clamps  
1 - Crane  
**CALL FOR BEST PRICE**



## QUANTUM ULTRA LIGHT GUNS

All Feature:

- High Transfer Efficiency up to 65%
- HVLP Gravity Feed design
- Finest Atomization
- Stainless Steel Needle & Tip
- Unibody Head to Eliminate Leaks After Cleaning



Part #	Nozzle	Sale	Club
ASTEUROHV103	1.3mm	\$124.94	<b>\$99.95</b>
ASTEUROHV105	1.5mm	\$124.94	<b>\$99.95</b>
ASTEUROHV107	1.7mm	\$124.94	<b>\$99.95</b>

- HVLP Gravity Feed design
- Includes regulator and gauge
- Stainless steel needle



Part #	Nozzle	Sale	Club
TIT19000	1.4mm	\$66.19	<b>\$52.95</b>
TIT19018	1.8mm	\$66.19	<b>\$52.95</b>
TIT19023	2.3mm	\$66.19	<b>\$52.95</b>



**TIT19221**  
4pc HVLP Gravity Feed Kit w/Case  
Kit includes: 1.7, & 1.4mm guns, 1.0mm touch-up, & regulator with gauge.  
Sale \$187.44 **Tool Club \$149.95**



**IWA9276**  
HVLP Gravity Spray Gun Kit  
Includes 1.3, 1.5, 1.8 needle and tip sets. Includes case, 600 ml plastic cup, air regulator, wrench, & gun lube.  
Sale \$362.44 **Tool Club \$289.95**



**AST4008**  
1.8mm Spray Gun  
Fully adjustable pattern control. 1 qt capacity cup.  
Sale \$55.63 **Tool Club \$44.50**



**TIT19302**  
2pc Disposable **TITAN** Air Line Filters  
Removes moisture, oil vapor, and rust particles. Mounts at spray gun.  
Sale \$93.69 **Tool Club \$74.95**



## WORK BENCHES

**AST557100**  
Fender Extender-80" Adjustable Extension  
Adjusts from 77.5" - 80" long.  
Sale \$30.63 **Tool Club \$24.50**



**AST557003**  
Portable Work Bench  
500 lb capacity.  
Sale \$62.44 **Tool Club \$49.95**



**AST557005**  
Portable Work Bench With Sling  
500 lb capacity.  
Sale \$69.94 **Tool Club \$55.95**



**ASTEVOT14**  
EuroPro Forged EVO-T Spray Gun with Plastic Cup  
1.4mm Nozzle  
"Air Curtain" design to minimize overspray  
Lightweight: 285 grams (0.6 lbs)  
M11\*P1.5 female thread fluid joint  
Sale \$137.44 **Tool Club \$109.95**



## RECIPROCATING SAWS



**MLW6509-31**  
12 Amp 3/4" Stroke SAWZALL Reciprocating Saw w/ Hard Case  
0-3,000 SPM. 3/4" Stroke Length. Quick-Lock blade clamp provides fast, tool-free blade changes for less downtime. Counter weighted mechanisms for reduced vibration & smoother operation. Gear protected clutch.  
Sale \$193.13 **Tool Club \$154.50**



**MK9557PBX1**  
4-1/2" Angle Grinder Kit  
7.5 Amp motor. 11,000 RPM. AC/DC paddle switch for use with alternative power sources. Large paddle switch for easy operation  
Sale \$137.44 **Tool Club \$109.95**



**MLW2821-21**  
M18™ FUEL™ Cordless Sawzall Kit Gen II  
Includes (1) 5 Amp battery with charger. POWERSTATE™ Brushless Motor.  
Sale \$485.63 **Tool Club \$388.50**



**MLW2780-22**  
M18 4-1/2" Cordless Grinder Kit  
Brushless motor. Same performance as corded grinders. Tool free accessory changes. Includes 2 batteries, charger, & carrying case.  
Sale \$661.88 **Tool Club \$529.50**

## POLISHERS



**MK9237CX3**  
7" Polisher  
10 Amps. Includes canvas bag and 3 pads. Extra low speed for clear coat polishing. Variable speed dial and trigger maintain constant speed under load. 0-3,200 RPM.  
Sale \$349.94 **Tool Club \$279.95**



**DWTDW849X**  
7" High Performance Electronic Polisher  
Controlled finishing system with soft start. Electronic controls specified speed under load. Variable speed dial: 0-3500 rpm. Wool ingestion shields on the air intake. Bale & straight handle. Weight: 6.7lbs.  
Sale \$362.44 **Tool Club \$289.95**



**MLW2660-21CT**  
**M18 FUEL™**  
**1/4" Blind Rivet**  
**Tool w/**  
**ONE-KEY™ Kit**  
 • 4,500 lbs of pulling force.  
 • Pulls up to 9/32" stainless steel rivets.  
 • Use with Aluminum, Steel, & Stainless Steel.  
 • Includes tool, 1 M18™ CP2.0 Battery, Charger and Contractor Bag.  
 Sale \$999.94 **Tool Club \$799.95**

**MLW2660-20**  
**M18 FUEL™ 1/4" Blind Rivet Tool with**  
**ONE-KEY™ - TOOL ONLY**  
 Sale \$874.94 **Tool Club \$699.95**

**MLW2550-22**  
**M12™ Rivet**  
**Tool Kit**  
 Pulls up to 3/16" stainless steel rivets. 450 1/8" steel rivets per charge. Aluminum, Steel and Stainless Steel capacity.  
 Sale \$487.49 **Tool Club \$389.99**

**MLW2550-20**  
**M12 FUEL™ Rivet Tool - TOOL ONLY**  
 Sale \$292.44 **Tool Club \$233.95**

**Astro Pneumatic**

**ASTPR14**  
**1/4" Air Operated Rivet Gun**  
 Nosepiece Sizes:  
 1/4", 3/16", 5/32", 1/8", & 3/32".  
 • Performs well at any angle.  
 • Overall length: 10-7/8".  
 • Weighs only 3.5 lbs!  
 Sale \$133.13  
**Tool Club \$106.50**



**RIVETS**

**TA19800**  
**1/4" H.D. Rivet Gun**  
 Redesigned tool is more durable, and includes a holder for used pins.  
 Sale \$52.44 **Tool Club \$41.95**

**AST1426**  
**1/4" H.D. Rivet Gun**  
 With holder for used pins.  
 Sale \$47.19 **Tool Club \$37.75**

**TA19830**  
**1/4" H.D. Extra Long Rivet Gun**  
 Extra long nosepiece will reach deep into grills and other recessed areas.  
 Sale \$83.69 **Tool Club \$66.95**

**TA19400**  
**Tool for Plastic Rivets**  
 Sets all sizes with single nosepiece.  
 Sale \$31.19 **Tool Club \$24.95**

**TA19200**  
**HD Hand Riveter Kit**  
 Use to set 3/32", 1/8", 5/32" and 3/16" rivets. 4 nosepieces and 40 rivets.  
 Sale \$24.94 **Tool Club \$19.95**

**AST1452**  
**XL Thread Setting Riveter**  
 Sets extra large rivet nuts up to 1/2" & M12. Tool-less quick change head design. Includes 10pc rivet nuts.  
 Sale \$124.94 **Tool Club \$99.95**

**AST1442**  
**Thread Setting Riveter**  
 6 interchangeable mandrel/nosepiece sets. Metric: M5, M6 & M8 SAE: 10-24, 1/4-20, & 5/16-18  
 Sale \$117.81 **Tool Club \$94.25**

**AST1453**  
**Combination Rivet Nut & Pop Rivet Setter Kit**  
 Tool-less quick change design easily transforms between pop rivet, rivet nut & nibbler functions. Includes attachments for blind rivet sizes in 3/32", 1/8", 5/32", 3/16" and 1/4", rivet nut attachments in M5, M6, M8, 10-24, 1/4", 5/16" & round and right-angle sheet metal nibbler.  
 Sale \$117.81 **Tool Club \$94.25**

**THREAD SETTERS**

**ASTADR14**  
**XL Blind Rivet Adapter Kit - 1/4"**  
 • Easily convert your cordless, pneumatic or corded drill into a power pop riveter.  
 • Includes nose pieces for 3/32", 1/8", 5/32", 3/16", 7/32" & 1/4".  
 Sale \$91.56 **Tool Club \$73.25**

**MAR39302**  
**SAE Rivet Nut Thread Setter Kit**  
 Includes thread setter tool w/ 8-32, 10-32mm & 1/4-20 mandrels & nosepieces.  
 Sale \$137.44 **Tool Club \$109.95**

**MAR39303**  
**METRIC Rivet Nut Thread Setter Kit**  
 Includes thread setter tool w/ 4mm - 8mm mandrels & nosepieces.  
 Sale \$187.44 **Tool Club \$149.95**

**AST1443B**  
**Professional SAE & Metric Hand Rivet Nut Kit**  
 Only 7.5" long. Includes rivet nut assortment and sizes M4, M5, M6, 8-32, 10-24 and 1/4-20.  
 Sale \$60.63 **Tool Club \$48.50**

**STEEL RIVET NUTS**



Part #	Pcs.	Sizes	Sale	Club
ASTRN120	120	Assorted	\$16.88	\$13.50
ASTRN4M	100	4mm	\$6.88	\$5.50
ASTRN5M	100	5mm	\$7.19	\$5.75
ASTRN6M	100	6mm	\$7.81	\$6.25
ASTRN8M	100	8mm	\$14.06	\$11.25

**TA15210**  
**1/8" Double-Ended Drill Bits**  
 Tube of 10.  
 Sale \$8.69 **Tool Club \$6.95**



**TIT45228**  
**Aluminum Rivets**  
 500pc assortment.  
 Sale \$14.94  
**Tool Club \$11.95**



**WILW5250**  
**80pc Poly Rivet Assortment**  
 Sale \$12.44  
**Tool Club \$9.95**



**TA18000**  
**Spot Weld Cutter**  
 3/8" double ended rotary bit.  
 Sale \$19.38 **Tool Club \$15.50**



**RIVET ASSORTMENTS**

**WILW5251**  
**120pc SAE Threaded Rivet Assortment**  
 Sale \$15.63  
**Tool Club \$12.50**



**WILW5252**  
**120pc Metric Threaded Rivet Assortment**  
 Sale \$15.63  
**Tool Club \$12.50**



**AST1721**  
**Spot Weld Drill Replacement Bit**  
 Sale \$19.38  
**Tool Club \$15.50**



## HEAVY DUTY SANDING BLOCKS

Part #	Length	Sale	Club
MOTBG12-1	12"	\$16.56	<b>\$13.25</b>
MOTBGR12-1	12" Rigid	\$19.06	<b>\$15.25</b>
MOTBGK12-1	12" Hook	\$19.06	<b>\$15.25</b>
MOTBGRK12-1	12" Rigid Hook	\$24.38	<b>\$19.50</b>
MOTBGR16-1	16" Rigid	\$28.75	<b>\$23.00</b>
MOTBGRK16-1	16" Rigid Hook	\$37.44	<b>\$29.95</b>

- Engineered from super-dense, light-weight material.
- Provide just the right amount of flex to conform to body panels and slight contours.



## WINDSHIELD TOOLS

### TA87460

#### Windshield Removal Kit

Kit contains the basic tools & wire needed for removing even the most modern windshields. Even works on acutely angled windshields. Supplied in a durable, vinyl pouch.

Sale \$58.69

**Tool Club \$46.95**

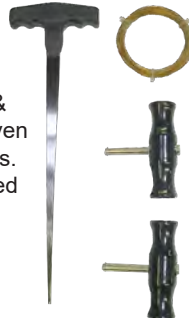

### TA87890

#### 24" Urethane Knife

Sale \$29.38

**Tool Club \$23.50**



### TA87900

#### Windshield Knife

Sale \$22.81

**Tool Club \$18.25**



### LIS63900

#### Suction Cup Window Holder

Sale \$21.19

**Tool Club \$16.95**



### TA87360

#### Suction Cup, Lever Activated

Capacity 80 lbs.

Sale \$15.63

**Tool Club \$12.50**



### ASTWINDKO

#### Windshield Remover



3 different blades. 20,000 oscillations per minute. Sealant cutter that cuts around bonded and encapsulated glass. Flexible blade mount can be positioned in 12 different ways (at 30° increments).

Sale \$104.94

**Tool Club \$83.95**



### LIS35150

#### Window Belt Molding Remover

Fits most vehicles.

Sale \$19.94

**Tool Club \$15.95**



### LIS35240

#### Belt Molding Tool

Unique design to insert under the molding at any angle.

Sale \$25.63

**Tool Club \$20.50**



## REPLACEMENT BLADES



Part #	Sale	Club
ASTWINDK08E	\$14.38	<b>\$11.50</b>
ASTWINDK08H	\$19.38	<b>\$15.50</b>
ASTWINDK08J	\$22.44	<b>\$17.95</b>

## TRIM CLIPS

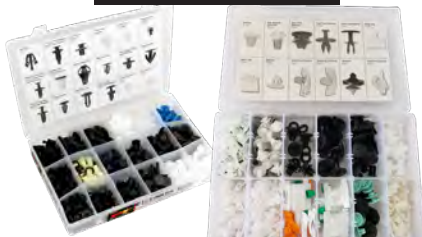

Contains all essential retainer, fasteners and clips for each company. Parts are made of OEM quality nylon for OEM installation, fit, and finish. Includes convenient organizer with illustrated insert for quick part reference.

Part #	Description	Sale	Club
WILW5240	350pc - GM	\$52.44	<b>\$41.95</b>
WILW5241	415pc - Ford	\$37.44	<b>\$29.95</b>
WILW5242	215pc - Chrysler	\$33.13	<b>\$26.50</b>
WILW5243	340pc - Toyota	\$43.69	<b>\$34.95</b>
WILW5244	418pc - Honda	\$43.69	<b>\$34.95</b>
WILW5248	290pc - BMW	\$31.19	<b>\$24.95</b>
WILW5249	255pc - VW	\$31.19	<b>\$24.95</b>
WILW5256	160pc - Audi	\$30.63	<b>\$24.50</b>
WILW5257	270pc - Mercedes	\$30.63	<b>\$24.50</b>
WILW5258	408pc - Nissan	\$36.19	<b>\$28.95</b>

## HEAT GUNS

### TIT22400

#### Heat Gun Kit

Heat settings: 500° & 1000°F.

2 fan speeds: 7 & 9 CFM.

Resettable thermostat.

Sale \$34.94 **Tool Club \$27.95**



### MSTEC-200K

#### Variable Temperature Heat Gun Kit

Range: 100°F - 930°F.

Two Fan Speeds - High and Low (5 & 9 CFM).

Built-in hand guard.

Includes tool, 7/16" air reducer attachment,

1 shrink tubing attachment,

1-15/16" & 3-1/8" spreader attachment,

1 flat metal scraper & 1 scraper handle with 3 interchangeable blades.

Sale \$86.56 **Tool Club \$69.25**



### MSTHG-501D

#### Industrial Master "D-Series" Heat Gun

27 CFM & 3,400 FPM. Quick-change plug-in heating element. Ergonomic soft grip handle. Die cast aluminum housing.

Max temperature: 1,400°F (649°C).

Sale \$206.19 **Tool Club \$164.95**



### MLW2688-21

#### M18™ Compact Heat Gun Kit

Reach operational temperature in 7 seconds.

Guarded nozzle. 6.4" long.

Built in ladder hook and LED light. Includes tool,

(1)M18 REDLITHIUM™ XC 5.0 Extended Capacity Battery, (1) M12™ & M18™ Multi-Voltage charger, (1) 3/8" concentrator nozzle and (1) hook nozzle.

Sale \$374.94 **Tool Club \$299.95**



### MLW2688-20

#### M18 Compact Heat Gun (TOOL ONLY)

Sale \$173.69 **Tool Club \$138.95**

### DFDM555UDX

#### Ultra Ding Massager

Squeezer Puller allows for a "massaging" action that helps release tension in the metal, allowing for a quicker, more successful pull. Includes T-Puller, Knock down tool with 2 heads (pointed and rounded), Slide Hammer, and 120V glue gun.

Sale \$562.44 **Tool Club \$449.95**



### UNIDTK7700

#### Uni-Vac Dent Puller

Includes 3 different sized vacuum cups & case.

Self-contained vacuum feature, no airlines required. Works on steel or aluminum panels, as well as bumpers.

Sale \$237.44 **Tool Club \$189.95**





**SUNEX8200**  
**Surface Blaster Kit**  
 180° rotating handle. Remove rust, gaskets, paint, or pinstripes. Includes stripping wheel, rubber erasing wheel, hub, and 3 wire wheels.  
 Sale \$432.81 **Tool Club \$346.25**

**SUNEX8200REW**  
**SX8200 Rubber Replacement**  
 Sale \$28.75 **Tool Club \$23.00**

**AST400E**  
**Smart Eraser - 4"**  
 5/16" - 24 thread arbor.  
 Sale \$14.38 **Tool Club \$11.50**



**IR324**  
**Pinstripe Removal Set**  
 3,700 RPM to remove decals, pinstripes, and other adhesives, without damaging paint. Includes (12) 4" pads.  
 Sale \$187.44 **Tool Club \$149.95**



**IR325B**  
**Air Nibbler**  
 Nibbles steel, plastic, tin, aluminum & other metals up to 18 gauge at 6ft/min.  
 Sale \$249.94  
**Tool Club \$199.95**



**ACA6330**  
**18 Gauge Nibbler**  
 2,500 Strokes/Minute.  
 3/16" Cut Radius.  
 Cuts steel up to 18 gauge.  
 Sale \$172.44  
**Tool Club \$137.95**



**ASTDS1000**  
**Door Skinner Tool**  
 Extra fast, with factory like results in one pass. Will roll steel flanges and leave the flange smooth.  
 Sale \$183.69 **Tool Club \$146.95**



**ASTDS2000**  
**Pneumatic Door Skinner Tool**  
 Forged and hardened steel de-crimping head. Precision machined aluminum body components, hardened shafts, and ball bearing construction throughout, for long life and maximum durability.  
 Sale \$183.69 **Tool Club \$146.95**



**IR125**  
**Air Scaler**  
 For removing heavy rust and scaling.  
 19 needles. 4,600 blows/minute  
 Sale \$262.44 **Tool Club \$209.95**



**AST4320**  
**In-line Needle Scaler**  
 For scaling and rust removal. Includes needle scaler attachment w/ 12 steel needles.  
 Sale \$124.99 **Tool Club \$99.99**

**AIR BELT SANDER**



**AST3037**  
**Air Belt Sander**  
 Includes 3 sanding belts (40, 60 & 80 grit). 1/2" x 18" belt. Variable speed control.  
 Sale \$135.63 **Tool Club \$108.50**

Replacement belts come in packages of 10.

Part #	Grit	Sale	Club
AST303736	36	\$15.63	\$12.50
AST303740	40	\$15.63	\$12.50
AST303760	60	\$15.63	\$12.50
AST303780	80	\$15.63	\$12.50
AST3037100	100	\$15.63	\$12.50

**OMEGALIFT**

**OM47020**  
**2,000 lb 3-in-1 Car Dolly Set (PAIR)**

- Holds vehicle by the wheel, by the pinch weld, or by the frame.
- No adapters required.
- Integrated frame adapters.
- Locking casters.
- No tools required.
- Adapter secured with pins.
- Self-stacking.
- Allows convenient storage.
- Sold in pairs of 2.

Sale \$599.94 **Tool Club \$479.95**



**KLR-ART401**  
**Digital Aluminum / Steel Stud Welder**  
 Dual purpose. Welds aluminum and/or steel studs. 110V charging system with heavy duty capacitors. Ready to go lever puller, T-Handle Puller, variety of steel and aluminum studs. 5 Year Warranty.  
 Sale \$2,868.75 **Tool Club \$2,295.00**



**KLR-ART38-110**  
**The Original Shark 110V**  
 Compact & powerful with 20' extension cord. 5 times faster than a pin welder. Leverage puller for power pulls. Comes with 3 electrodes, wiggle wire & a 6-finger claw. Built in USA with a 5 year warranty.  
 Sale \$1,562.44 **Tool Club \$1,249.95**



**KLR-ART903M**  
**Telescoping Tram Gauge**  
 Telescoping construction with quality anodized aluminum. Comes with 4 pointers. .2 - 5" + 2 graduated pointers 11", complete with 2 nylon storage bags. extends from 28" to 10 feet. Accuracy within 2mm.  
 Sale \$324.94 **Tool Club \$259.95**

**FIR0384-0977  
Oxy-Acetylene  
Torch Kit**

Welds to 1/4", cuts to 3".  
Lightweight outfit for easy transport.  
Medium duty with cylinders, regulators, & goggles.  
Complete portable system.  
12.5' hose and 150 series regulators.  
Sale \$749.94 **Tool Club \$599.95**



**FIR1423-1108  
Acid Flux Core  
40/60 Solder 1/8" x 1/4 lb**

Great for sheet metal join & fitting connections. for non-electrical work.  
Sale \$10.31 **Tool Club \$8.25**



**DF601A  
Surge Protector**

Works on 12 & 24V systems.  
Increases voltage surge protection during mig and spot welding, jump starts, plasma cutting, and other repair applications.  
Sale \$87.44 **Tool Club \$69.95**



**TIT41197  
Welding Cart**

For storing & transporting most MIG & Plasma machines, shielding gas tanks & other welding equipment and accessories. Front mounted handle for easy maneuverability.  
Sale \$105.94 **Tool Club \$84.75**



**TIT41217  
Welding Goggles**

Anti-Scratch. Anti Fog.  
Perfect for light to medium work.  
Flexible 180° Viewing Angle.  
Sale \$19.94 **Tool Club \$15.95**



**FIR0387-0463  
Self Lighting TORCH ONLY**

Lights with pull of trigger.  
Safety trigger lock.  
180° swivel tip.  
Can be used with MAP-Pro or propane without changing the orifice.  
Fits any standard cylinder.  
Sale \$74.19  
**Tool Club \$59.35**



**FIR0387-0464  
Self Lighting  
TORCH KIT with Propane**

Sale \$80.44 **Tool Club \$64.35**

**FIR0387-0436  
Disposable 1lb  
Propane Tank - 14.1oz**

Sale \$15.44  
**Tool Club \$12.35**



**FIR0916-0122  
AirFuel™ MAP/Pro  
Replacement Tank - 14.1oz**

Sale \$20.63  
**Tool Club \$16.50**

**GAS WELDERS**

12.5 FT.  
HOSE



**FIR0384-2571  
250 Medium Duty Outfit  
250 Series Regulators**  
Cuts up to 5". Welds to 1/2".  
High performance complete system.  
For medium duty fusion welding, braze welding, brazing, heating, and hand cutting applications.  
Sale \$403.44 **Tool Club \$322.75**



**FIR0384-2573**

**Torch Replacement Kit**  
Cutting torch and handle are ready for multiple gas options.  
Ergonomic coded knobs.  
Cut 1/8" (3.2mm) - 5" (127mm) steel.  
Weld up to 1/2" steel.  
Allows upgrades to the latest generation of torch and handle design. U.L Listed.  
Sale \$233.69 **Tool Club \$186.95**

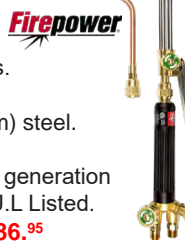

**WELD550PK  
8pc 120V Professional  
Soldering Gun Kit  
- 260/200 Watts**

Sales Price \$87.44  
**Tool Club \$69.95**



**FIR1440-0096  
5/32" x 5lb Mild Steel Arc Welding Electrodes**  
Premium AWS Class E-6011. AC or DC, reverse polarity. All position electrode.  
Sale \$15.63 **Tool Club \$12.50**

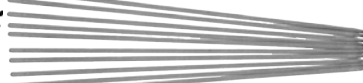

**TIT41300  
Welding Blanket - 4' x 6'**

Working Temperature: 1,000°F  
Protect equipment from sparks & splatters  
Sale \$34.38 **Tool Club \$27.50**



**FIR1423-0017  
Fixed Front Welder's  
Goggles w/ Soft Frame**

Shade #5 Filter Lenses.  
Fits easily over corrective glasses. Hooded vents prevent fogging & offer excellent ventilation.  
Sale \$15.63 **Tool Club \$12.50**



**REGULATORS**



**FIR0781-9826  
Oxygen Medium Duty**  
Sale \$151.19  
**Tool Club \$120.95**



**FIR0781-9827  
Acetylene Medium Duty**  
Sale \$151.19  
**Tool Club \$120.95**



**FIR0384-2682  
350 Heavy Duty Outfit  
350 Series Regulators**  
Cuts up to 6". Welds up to 1/2".  
Includes flashback arrestors.  
Optimized for 1" out of the box.  
Sale \$522.44 **Tool Club \$417.95**



**TIT41225  
Chipping Hammer**  
Use to chip & remove slag from welds.  
Sale \$9.94 **Tool Club \$7.95**



**FIR1423-0086  
H.D. Cone & Chisel Chipping Hammer**  
Holds up to 10lbs of 12" or 14" electrodes.  
Wide-blade design removes slag faster & adds to life of the tool. Spring handle.  
Sale \$12.44 **Tool Club \$9.95**



**SOLDERING KITS**



**PPPS50W  
Pro-Solder 50W**  
Max Temp: 1,112°F  
Running Time: 35 minutes. Charging time: 3.5hrs.  
Reaches operating temperature (536° F) in 10 seconds. 50 Watt. LED Light.  
Sale \$115.63 **Tool Club \$92.50**



**PPMTKIT01  
Butane  
Soldering  
Torch Kit**  
Includes PPMT torch, blower tip, heat shrink adapter shield, hot knife, soldering tip, solder attachment, rosin core solder.  
Sale \$112.44 **Tool Club \$89.95**

**PPMT  
Portable  
Butane Torch**  
Max temp 2500°F as torch and 950°F for soldering.  
Sale \$62.44 **Tool Club \$49.95**



**PPSK  
Butane  
Soldering  
Torch Kit**  
Tool can work as a soldering tool or as a torch. Can solder, heat shrink, and cut plastics.  
2500°F torch. 950°F soldering / heating tip temp.  
Sale \$78.13 **Tool Club \$62.50**

**ESAB2051C**  
**ESAB Rebel 2051C AC/DC**  
**Multi-Process Welder**  
 MIG Flux-Cored, Stick, DC TIG, DC Pulse TIG, and AC TIG capabilities. Voltage 120/230V. Comes with: 10-foot Tweco Fusion 180 MIG gun. 13-foot Tweco 200A electrode holder. Tweco ground clamp with leads. Wired Foot Control. Tweco 12.5Ft 17 Series TIG torch & accessories (3 Collets and Collet Bodies (1/16, 3/32, 1/8). 1 Short Backcap | 1 Long Backcap | 3 Tungsten (1/16, 3/32, 1/8) | 3 Cups (#5, #6, #8). Victor Argon/CO2 Flowmeter Regulator with 10-foot gas hose. 230V Plug Installed (120V Adapter Plug Included)  
**CALL FOR BEST PRICE**



**LINCOLN ELECTRIC**  
**LNEK2697-1**  
**Easy Mig 140 Welder**  
 Welds 24 gauge to 5/16". Uses 120V input power. Aluminum spool gun ready.  
 Sale \$999.94 **Tool Club \$799.95**



**LINCOLN ELECTRIC**  
**LNEK2698-1**  
**Easy Mig 180 Welder**  
 Use 208/230V input power and weld up to 3/16" MIG and 1/2" gas-less flux-cored.  
 Sale \$1,249.94 **Tool Club \$999.95**



**WELDING HELMETS**

**TIT41265**  
**Solar Powered Welding Helmet (Eagle)**  
**TITAN**  
 Utilizes solar cells with battery backup. DIN 9 to DIN 13 as variable shade. Automatically changes from light to dark shade when arc is struck.  
 Sale \$114.94 **Tool Club \$91.95**



**JAC46200**  
**Rebel ADF Welding Mask**  
 One-piece design protects against UV & IR leakage as well as spark & spatter penetration. Includes hood made of high-performance flame-resistant fabric. Battery lasts 1,300 hours (replaceable).  
 Sale \$259.69 **Tool Club \$207.75**



**JAC46240**  
**TRANSLIGHT™ 455 Flip Premium Auto Darkening Helmet**  
 Switching speeds of 1/40,000 sec. ADF filter scores of 1/1/1/1 rating.  
 Sale \$412.44 **Tool Club \$329.95**



**JAC46250**  
**TRANSLIGHT™555 + Premium Auto Darkening Helmet**  
 Switching speeds of 1/25,000 sec. ADF filter scores of 1/1/1/1 rating  
 Sale \$412.44 **Tool Club \$329.95**



**LINCOLN ELECTRIC**  
**LNEK2278-1**  
**Handy Core Wire Feeder Welder**  
 Welds 18 gauge to 1/8" mild steel. Includes gun, cable assembly, work lead, work clamp, flux core wire, hand shield, chipping hammer & input power cable. 35-88 amps output.  
 Sale \$499.94 **Tool Club \$399.95**



**LINCOLN ELECTRIC**  
**LNEK2535-1**  
**Precision TIG® 225 208/230/1/60**  
 • Just select mode, polarity, and weld!  
 • Stick welding up to 5/32" (4.0mm).  
 • TIG pulser minimizes distortion.  
 • 5 - 230 Amps.  
 • Includes 150 amp torch with 12.5' long cable.  
**CALL FOR BEST PRICE**



**LNEK2820-1**  
**20 Plasma Cutter**  
 • Rated Output: 20A @ 40%, 10-15A @ 50%  
 • Input Current: 20A  
 • Input Power: 115/1/60  
 • Cutting Capacity: 1/8" - 1/4"  
 • 65 PSI @ 3.5 CFM  
 • Includes cutting torch assembly with 9.5 ft. reach, ground clamp with 8 ft. cable, power cord and plug.  
 Sale \$1,562.44 **Tool Club \$1,249.95**



**FLAMELESS HEAT TOOLS**

**IDIMDV787**  
**Mini-Ductor™ Venom HP**  
 Generates Invisible Heat® to release ferrous and some non-ferrous metals from corrosion & thread lock compounds without the dangers of open flame and up to 90% faster.  
 Sale \$699.94 **Tool Club \$559.95**



**IDIMD700**  
**Mini-Ductor II**  
 Faster and safer than a torch. Instantly heats and removes seized nuts, bearings, and other metal without the danger of an open flame. 1,000 watt handheld induction power inverter. LED for increased vision. High frequency magnetic fields to heat only metal.  
 Sale \$549.94 **Tool Club \$439.95**



**IDIMD99-650**  
**Mini-Ductor™ Coil Kit**  
 For use with Mini-Ductor II. Enables the user to heat and release siezed nuts and bolts up to 1-1/2" in diameter and other metallic hardware from corrosion and / or thread lock compounds.  
 Sale \$186.88 **Tool Club \$149.50**

**IDIMD99-643**  
**Mini-Ductor™ Bearing Buddy Coil Pack**  
 Includes: 41" & 96" Bearing Buddy Coils and (1) 6" x 12" Heat Resistant Insulator mat.  
 Sale \$112.44 **Tool Club \$89.95**



**MIG WIRE**

Part #	Wire	Spool	Sale	Club
SH12000	.023"	2LB.	\$14.38	<b>\$11.50</b>
SH12001	.023"	11LB.	\$45.94	<b>\$36.75</b>
SH12003	.030"	11LB.	\$43.13	<b>\$34.50</b>
SH12007	.035"	33LB.	\$86.56	<b>\$69.25</b>

**FLUX CORE WIRE**

Part #	Wire	Spool	Sale	Club
SH12008	.030"	2LB.	\$26.56	<b>\$21.25</b>
SH12009	.035"	2LB.	\$26.56	<b>\$21.25</b>

**SHARK WELDING GLOVES**

Part #	Color	Sale	Club
SH14401	Grey	\$16.88	<b>\$13.50</b>
SH14402	Brown	\$16.88	<b>\$13.50</b>
SH14404	Red	\$19.38	<b>\$15.50</b>





**AST9406**



**7pc Hose Plier Set**

Master set will remove and install virtually every type of hose clamp. Includes 6 types of pliers plus the flexible hose clamp pliers with 24" cable. Sale \$162.44 **Tool Club \$129.95**



**KDT3975D**

**Hose Clamp Plier**

Features swivel jaws. Sale \$33.69 **Tool Club \$26.95**



**LIS17460**

**Curved Hose Clamp Pliers**

Ergonomic curved design makes pliers easy to use in hard-to-reach areas. Sale \$54.94 **Tool Club \$43.95**



**LIS35070**

**Button Connector Pliers**

Disconnects fuel line, EVAP line and DEF fittings with tabs that must be depressed to disengage. Sale \$90.63 **Tool Club \$72.50**



**Hose Pinch Pliers**

Self locking feature. Offset design. Used to seal vacuum, fuel line, radiator hoses, and other flexible materials.

Part #	Size	Sale	Club
LANG1460	Small	\$22.81	<b>\$18.25</b>
LANG1470	Medium	\$27.44	<b>\$21.95</b>
LANG1480	Large	\$39.38	<b>\$31.50</b>
LANG1500	SET	\$82.44	<b>\$65.95</b>



**LIS44500**

**Small Hose Clamp Vise**

Vise design fits in tight spots & is 3" long. Opens to 1-1/2". Can be tightened by hand or with a 1/4" drive ratchet. Sale \$30.31 **Tool Club \$24.25**

**HOSE CLAMP PLIERS**



**LIS17000**

**Long Reach Hose Clamp Pliers**

Cross-cut tip design grips most hose clamps from multiple angles. Ratcheting lock mechanism holds the clamp in an open position for hands-free use. Dual material grips for comfort. Overall tool length of 17" provides extra long reach. Sale \$62.44 **Tool Club \$49.95**

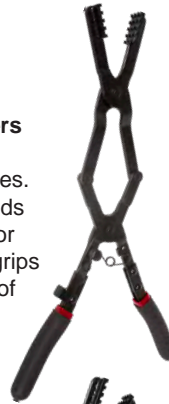

**MAY28680**

**Flexible Hose Clamp Plier**

Clamps up to 2". H.D. cable. Pivoting jaw piece. Ratchet lock with slide guide. Sale \$104.38 **Tool Club \$83.50**



**LIS17370**

**35° Long Hose Clamp Pliers**

Provides an extra long reach & 35° angled tips for hard-to-reach hoses. Cross-cut tip design grips most hose clamps from multiple angles. Ratcheting lock mechanism holds the clamp in an open position for hands-free use. Dual material grips for comfort. Sale \$68.69 **Tool Club \$54.95**



**AST9409A**

**Flexible Hose Clamp Plier**

Double gear lock lever. Large cable and strong connection. Cable adjuster and multiple gear lock. Precision clamp for extended reach. Sale \$49.94 **Tool Club \$39.95**



**HOSE TOOLS**

**CTA4029**

**Clic Hose Clamp Pliers**

Lock and unlock Clic and Clic-R re-usable hose clamps. Sale \$29.38 **Tool Club \$23.50**



**KDT145**

**Hose Pinch-Off Plier**

Sale \$31.88 **Tool Club \$25.50**



**CTA1048**

**Large Hose Clamp Pliers**

30mm circle head. Spring loaded. Opens up to 55mm. Features 30° bend. Sale \$41.88 **Tool Club \$33.50**



**LIS11420**

**Hose Cutter**

Cuts hoses up to 1 1/4". Sale \$28.44 **Tool Club \$22.75**



**LIS47900**

**Hose Removal Pliers**

Removes vacuum and fuel hoses up to 1/2". Sale \$12.44 **Tool Club \$9.95**



**WILW83205**

**3pc Line Clamp Set**

Built in locking mechanism. Sizes: 1/8" to 5/16", 1/2" to 3/4" & 3/4" to 2-1/2". Sale \$16.19 **Tool Club \$12.95**

**LIS22850**

**Hose Pinchers (PAIR)**

Pinch off vacuum, fuel, brake and other lines. Sale \$9.06 **Tool Club \$7.25**



**LIS44480**

**Large Hose Clamp Vise**

Vise design fits in tight spots & is 3-5/8" long. Opens to 2-1/8". Can be tightened by hand or with a 1/4" drive ratchet. Sale \$30.94 **Tool Club \$24.75**

**LIS23000**

**Hose Pinchers**

Clamps and holds hoses up to 3/4" I.D. Jaws are offset for hard-to-reach areas. Handles lock to hold jaws closed. Sale \$11.88 **Tool Club \$9.50**





**AST78585  
Radiator  
Pressure  
Tester &  
Vacuum  
Type  
Cooling Kit**

For domestic & import vehicles. Color coded radiator test caps. Special design of vacuum purge and refill tool fits nearly all radiator openings.  
Sale \$327.44 **Tool Club \$261.95**



**MSC43302  
25pc Master  
Cooling System Pressure Test Kit**

Detects & exposes external system leaks. Detects internal engine leaks due to blown gaskets or cracked block. Includes blue & black radiator cap test connectors. Includes hand pump, thermometer and 21 adapters to fit most popular domestic & import cars and truck.  
Sale \$274.94 **Tool Club \$219.95**



**FJC43660  
20PC  
Radiator  
and Radiator  
Cap Pressure  
Test Kit**

For use in pressure testing radiator caps and radiators. For use with most domestic and import autos and light trucks.  
Sale \$274.94 **Tool Club \$219.95**



**CTA7060**

**Radiator Pressure Tester**

Tests automotive pressurized cooling systems up to 30 PSI. Works with adapters from CTA7057 Kit.  
Sale \$137.44 **Tool Club \$109.95**



**CTA7057**

**10pc Radiator  
Adaptor Kit - US / Asian**

Includes: CTA7090, 7091, 7092, 7096, 7100, 7102, 7103, 7109, 7117, 7118.  
Sale \$437.19  
**Tool Club \$349.75**



**FJC43655  
H.D. Cooling  
System Pressure Test & Refill Kit**

Designed for use with Freightliner, International, Kenworth, Peterbilt, Volvo, GMC, MACK & Sterling cooling systems. Includes Heavy Duty Vehicle adapters, pressure test regulator, vacuum refill attachment with tubing, all in a durable storage case.  
Sale \$374.94 **Tool Club \$299.95**



**UV550000  
Airlift® Kit Radiator Filler**

Checks for leaks in the system and makes sure it holds the vacuum. Then it refills the system with fluid and eliminates air bubbles.  
Sale \$200.55 **Tool Club \$160.44**



**MITMV4560**

**Cooling System  
Pressure Test Kit**

Hand pressure pump to quickly reveal external cooling system leaks & detect internal leaks & defective caps.  
Sale \$82.44 **Tool Club \$65.95**



**PL75025  
Radiator Filler**

3 gallon capacity  
Sale \$33.69  
**Tool Club \$26.95**



**CTA7088  
Coolant System  
Filling Kit**

Allows proper air bleeding. Includes 4 adapters to service most US & Asian makes, and 45° elbow.  
Sale \$87.19  
**Tool Club \$69.75**



**RED95-0750  
SmartFit Radiator  
Adapter Set**

Works on the radiators of every car or light truck. Works with any standard cooling system pressure pump.  
Sale \$149.94 **Tool Club \$119.95**



**WILW54273  
Radiator Filler**

2.5 gallon capacity  
Sale \$29.94  
**Tool Club \$23.95**



**LIS24780  
18pc Spill-Free Funnel**

Includes new cap for Ford and additional straight extension.  
Sale \$61.19  
**Tool Club \$48.95**



**ATA PRESSURE TESTER ADAPTERS**



ADAPTERS ARE COMPATIBLE WITH MOST PRESSURE TESTERS

Part #	Fits	Sale	Club
CTA7091	Asian & More	\$35.63	<b>\$28.50</b>
CTA7092	Asian/Ford	\$37.44	<b>\$29.95</b>
CTA7093	Audi/VW w/ male threads	\$41.88	<b>\$33.50</b>
CTA7094	European	\$51.88	<b>\$41.50</b>
CTA7095	VW	\$56.88	<b>\$45.50</b>

Part #	Fits	Sale	Club
CTA7096	GM/European	\$54.69	<b>\$43.75</b>
CTA7097	BMW	\$66.25	<b>\$53.00</b>
CTA7098	VW/Audi	\$67.81	<b>\$54.25</b>
CTA7099	BMW	\$55.31	<b>\$44.25</b>
CTA7100	GM/Ford/Mercedes	\$60.63	<b>\$48.50</b>
MITMV4506	Universal	\$63.44	<b>\$50.75</b>

SAM303141

**PumpMaster 3 - 55:1 120lb Keg with 10' Hose Band Dolly**

Light weight and effective double acting high performance air operated pumps specially designed for use in mobile and portable greasing units. Pumps include a height adjustable 2" NPTM bung adapter. Pump Pressure Ratio - 55 : 1. Continuous Duty Flow Rate: 0.7 lb/min. Max Free Flow Rate: 1.2 lb/min. Max Outlet Pressure: 7,700 PSI. Air Pressure Operating Range: 20 - 140 PSI Sale \$1,037.44 **Tool Club \$829.95**



**SAMSON**

**NEW!**

LIS34550

**Bearing Packer**

Works on bearings up to 3.5" O.D. Sale \$34.69

**Tool Club \$27.75**



LCN5900

**Lever-Action Grease Coupler**

Works with all grease gun types. One handed operation.

Sale \$44.38 **Tool Club \$35.50**



**LINCOLN**

**SUCTION GUNS**

LCN615

**18oz. Capacity**

Sale \$28.13 **Tool Club \$22.50**



**LINCOLN**

MITMVA6851

**7oz Fluid Extractor**

7.5" flexible tube with a non-drip car. Enables access into tight spaces. Sale \$37.44

**Tool Club \$29.95**

**mityvac**



MITMVA6852

**1.5 Liter Fluid Extractor**

16" flexible hose. Easy disassembly and cleaning. Double-seal design. Sale \$72.44 **Tool Club \$57.95**



TIT51884

**Automotive Fluid Syringe**

For use with all types of automotive fluid. Detachable tube with cap disassembles for easy cleaning. Maximum Capacity: .21 QT. Sale \$36.88 **Tool Club \$29.50**

**GREASE PUMPS**

LCN917

**AIR OPERATED Grease Pump**

Dispenses 45oz or 80 in<sup>3</sup> per minute at 150 PSI. Assures positive prime at lowest temperature. 43-1/8" high. 17" square base. Drum not included. Sale \$1,374.94 **Tool Club \$1,099.95**



**MADE IN USA**

17" x 17" BASE

Includes rolling dolly For 120lb Drum

**LINCOLN**

LCN6917

**Air Operated Portable Grease Pump**

50:1 pneumatic pump. High pressure grease control valve. Universal swivel and coupler. 7' hose. Drum cover, flexible follower plate, and a band dolly with caster wheels. Sale \$1,124.94 **Tool Club \$899.95**



**LINCOLN**

LCN1293

**Hand Operated Gear Lube Pump**

Fits on any 25-50lb refinery container. Includes 5' hose. Sale \$103.13 **Tool Club \$82.50**



**GREASE PUMP ACCESSORIES**

**LINCOLN**

LCN740

**Control Handle**

Works with ANY grease pump. 1/4"NPTF inlet. Sale \$169.38

**Tool Club \$135.50**



LCN81387 Universal Joint

For the base of control handle. Sale \$105.63

**Tool Club \$84.50**

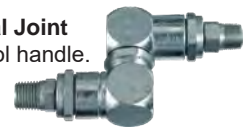

LCN75240 20' Grease Hose

Works with ANY grease pump. Sale \$124.94

**Tool Club \$99.95**



**GREASE ADAPTERS**

LCN58000

**7pc Lube Adapter Kit**

Press-on 90° lube tool, straight extension, 12" hose extension, Slide-On 90° coupler with right angle coupler, rubber tipped nozzle, needle nozzle & 360° coupler. Sale \$149.94 **Tool Club \$119.95**



**LINCOLN**

LCN5852 Coupler

For hand operated grease guns. Sale \$9.94 **Tool Club \$7.95**



LCN5883

**Right Angle Coupler**

Sale \$10.94 **Tool Club \$8.75**



LCN5845

**H.D. Coupler**

For air operated grease pumps. Sale \$15.63 **Tool Club \$12.50**



LCN5848

**Swivel Grease Coupler**

Sale \$59.69 **Tool Club \$47.75**



LCN5803

**Needle Adapter**

Sale \$17.44 **Tool Club \$13.95**



AFF8091

**Extra Fine Needle Adapter**

Sale \$8.69 **Tool Club \$6.95**



**AFF**

**FUEL TRANSFER**

**LINCOLN**

LCN1550

**Fuel Transfer Pump**

360° locking bung. Quickly transfer diesel, kerosene, or mineral spirits from mobile and stationary tanks. Sale \$499.94 **Tool Club \$399.95**



LCN3677

**25 Gallon Fuel Caddy**

2 way filter system. Dispenses or extracts fuel at a rate of 1 gallon per 12 revolutions. Easy-to read sight gauge. 7' wire reinforced hose. Sale \$874.94 **Tool Club \$699.95**



**FITTING CLEANERS**

LCN5805

**Impact Fitting Cleaner**

Clears obstructions with oil & pressure. Sale \$56.88

**Tool Club \$45.50**



**LINCOLN**



## DISCONNECT TOOLS

**CTA1809**  
5pc Fuel Line  
Flex Socket Set  
Sizes: 11, 13, 14,  
15 & 17mm  
Sale \$174.06  
**Tool Club \$139.25**



**KDT3321**  
Fuel Line Disconnect  
Sizes: 5/16" & 3/8"  
Sale \$27.44  
**Tool Club \$21.95**



**LIS39190**  
Heater Hose  
Disconnect GM 3/4"  
For heater lines on  
GM vehicles.  
Sale \$16.56 **Tool Club \$13.25**



**LIS39210**  
Main Fuel  
Line Disconnect  
For Toyota and Nissan.  
Sale \$23.13 **Tool Club \$18.50**



**CTA3466**  
BMW Disconnect Tool  
For Power Steering &  
Transmission lines  
'99 - '11 3 series & X5.  
Sale \$24.38 **Tool Club \$19.50**



**LIS39200**  
Heater Hose  
Disconnect for Ford 2.0L  
For 2012-2016 Ford Focus 2.0L  
& 2013-2016 Ford Escape 2.0L EcoBoost  
Sale \$9.38 **Tool Club \$7.50**



**LIS38450**  
STC Fitting  
Release Tool Set  
Sizes: 6, 8, & 10.  
Sale \$33.13  
**Tool Club \$26.50**



**LIS22990**  
4pc Low Profile  
Jiffy-Tite  
Disconnect Set  
Sizes: 3/8", 1/2",  
5/8" - 30%, 5/8" - 39%  
Sale \$98.13  
**Tool Club \$78.50**



**TA19700**  
8pc Adjustable  
Fluid Line Stopper Kit  
Use to seal metal lines once  
disconnected. Use with all  
automotive fluids. Adjusts & locks to 3 positions.  
Sale \$70.31 **Tool Club \$56.25**



**LIS67000**  
Master Line  
Stopper Set  
Includes stoppers, caps,  
and line clamp pliers for most  
internal & external lines.  
Sale Price \$82.44 **Tool Club \$65.95**



## GREASE GUNS

**LCN1142**  
Manual  
Grease Gun  
1 oz per 33 strokes.  
21-3/4" long.  
Sale \$41.19  
**Tool Club \$32.95**

**LINCOLN**



**LCN1134**  
HD Pistol Grip  
Grease Gun  
18" flexible hose with  
coupler & rigid tube.  
Develops up to 7500 PSI.  
Sale \$65.94 **Tool Club \$52.75**



**LCN1133**  
Pistol Grip Grease Gun  
Includes 18" whip hose  
& coupler.  
Sale \$59.69  
**Tool Club \$47.75**



**WILW54294**  
Clear View Pistol  
Grip Grease Gun  
Includes 12" hose with coupler.  
Develops 5,000 PSI. 3,000 PSI  
working pressure. 14oz capacity.  
Sale \$46.19 **Tool Club \$36.95**

**Performance Tool**  
**NEW!**



## AIR OPERATED

**LCN1162**  
Air Operated Grease Gun  
Uses standard grease tube. 30" hose.  
Max PSI: 6,000. Variable speed trigger.  
Sale \$131.88 **Tool Club \$105.50**



## GREASE HOSES

Part #	Length	Sale	Club
LCN5812	12"	\$24.94	\$19.95
LCN5818	18"	\$26.19	\$20.95

## POWERLUBER HOSES

Part #	Length	Sale	Club
LCN1230	30"	\$43.13	\$34.50
LCN5861	36"	\$42.19	\$33.75

**LUB11310**  
14oz Ultra Lube Multi Purpose Grease  
Economical multi-purpose lithium grease  
for general lubrication needs.  
Sale \$8.69 **Tool Club \$6.95**

**NEW!**



**MLW2446-21XC**  
M12™ Cordless  
12V Grease Gun  
Kit with 1 Battery.  
Powerful 12V motor  
delivers 8,000 PSI max operating pressure.  
Dispenses up to 7 cartridges per charge.  
Includes tool, charger, (1) M12 Battery & case.  
Sale \$314.38 **Tool Club \$251.50**

**NEW!**  
**Milwaukee**



## BATTERY OPERATED GREASE GUNS



**LCN1264**  
12V Li-Ion PowerLuber  
Includes cordless grease gun, 2 rechargeable  
lithium-ion batteries, charger, and carrying case.  
Built-in LED light. Integrated hose holder. Air  
purge valve. 8,000 PSI. 30" hose. Stable 3 point  
stance holds the tool upright & within reach.  
Sale \$312.44 **Tool Club \$249.95**



**LCN1888**  
20V Li-Ion PowerLuber  
Includes cordless grease gun, 2 rechargeable  
lithium-ion batteries, charger, 2 extra grease  
couplers, & carrying case. Stable 3 point stance  
keeps the tool upright. Electronically controlled  
two-speed motor. LED indicators identify  
empty cartridge, loss of prime, grease output,  
and blocked fitting. Built-in LED light.  
Flow meter prevents overflow and waste.  
Sale \$437.44 **Tool Club \$349.95**



**MLW2646-22CT**  
M18™ Cordless 2-Speed  
Grease Gun Kit with 2 Batteries  
Industry leading 10,000 PSI max operating  
pressure. Best in class 48" flexible hose.  
Air Bleeder Valve. Includes M18 & M12  
multi-voltage charger, 2 M18 compact  
REDLITHIUM™ battery.  
Sale \$484.38 **Tool Club \$387.50**

**Milwaukee**

**MLW2646-20**  
M18™ Cordless 2-Speed  
Grease Gun - TOOL ONLY  
Sale \$293.13 **Tool Club \$234.50**

**BRAKE BLEEDING**

**EVACUATORS**



**MITMV6840 Pressure Bleed System**

Includes a fluid dispenser with manual pump. Contains 7 master cylinder adapters. Forces new brake fluid down through the master cylinder, while air and old fluid are expelled through the bleed screw. 1.2 gallon fluid capacity. Sale \$453.13 **Tool Club \$362.50**



**MITMV6835 Vacuum Brake Bleed Kit**

Same as MITMV6830. Includes MITMVA6832 Clamp-On Auto Refill Kit. Sale \$274.94 **Tool Club \$219.95**



**CTA7015 Pressure Brake Bleeder**

Hand-operated, portable unit creates pressure to push brake fluid thru system. 3 liter capacity. Sale \$119.94 **Tool Club \$95.95**



**MITMV6838 Master Vacuum Brake Bleed Kit**  
MV6830 plus MVA6836 master cylinder auto-refill kit. Variable control thumb throttle. Swivel air inlet with quick disconnect. Two refill kit styles to fit all makes and models of vehicles. Sale \$311.88 **Tool Club \$249.50**

**CTA3930 11PC Brake Bleeder Adapter Set - Pro Series**

Serves Toyota, Lexus, Hyundai, Kia, Honda, Acura, Mitsubishi, Nissan, Suzuki, Mazda, Ford, Lincoln, Chevrolet, Cadillac, Buick, Chrysler, Dodge, Jeep, Ram, BMW, Land Rover, Fiat, Alfa Romeo, Volvo, Volkswagen, Audi & Porsche. Sale \$437.44 **Tool Club \$349.95**



**MITMV8000 Automotive Tune-up & Brake Bleeding**

For one-person brake bleeding. Selectline hand vacuum pump with vacuum gauge and accessories. Sale \$60.63 **Tool Club \$48.50**



**MIT8500 Silverline Tester Vacuum Kit**  
Produces vacuum or pressure at the turn of a switch. For one-person brake bleeding. Includes variety of adapters. Sale \$114.38 **Tool Club \$91.50**

**CTA7300 Complete Master Cylinder Adapter Kit**

Full set of adapters (European cap, USA, & Asian) to use with CTA7015 & most other pressure brake bleeders. Sale \$312.44 **Tool Club \$249.95**



**CTA7300M Complete Master Cylinder Adapter Kit Updated**

Full set of adapters (European cap, USA & Asian) to use with CTA7015 & most other pressure brake bleeders. Sale \$412.44 **Tool Club \$329.95**



**LUMLX1313 Manual/Pneumatic 2-in-1 Fluid Extractor**

Easy to operate. Convenient manual pump operation. Suitable for brake fluid, engine oil, gear oil, transmission fluid, water, etc. Non-spark. Non-power fluid extractor. Automatic overflow prevention. Quick-drain pour spout. 2.1L capacity. Sale \$199.94 **Tool Club \$159.95**



**MIT7300 Fluid Evacuator & Brake Bleeder**

This 2.3 gallon tank can extract many different fluids: oil, brake fluid, coolant, etc. Includes brake bleeding adapters. Sale \$155.63 **Tool Club \$124.50**



**MIT7400 Fluid Evacuator**

This 1.9 gallon tank can extract many different fluids: oil, brake fluid, coolant, etc. Use this where a drain is not available. Sale \$112.44 **Tool Club \$89.95**



**MIT7201 Fluid Evacuator Plus**

This creates both a vacuum and pressure. It can evacuate and dispense a wide variety of fluids. 2.3 gallon tank. Sale \$155.63 **Tool Club \$124.50**



**MITMV7412 2.5 Gallon ATF Refill Kit**  
Utilizes compressed "shop-air" for dispensing and extracting. Includes adapters for most modern sealed transmissions. Conveniently located ON/OFF and flow control valve. Used fluids or overflow can be extracted by switching from pressure to vacuum. Isolated flow control and pressure/vacuum switch valves provide simple functionality control. Redundant pressure control systems safely maintain peak output pressure below 30 psi (2 bar). 2.5-gallon (10-liter) capacity reservoir. Includes flex hose with control valve and wand. Sale \$499.94 **Tool Club \$399.95**

### LCN3639 25 Gallon Used Fluid Combo Drain

Collect used fluids including motor oil, transmission fluid, and coolant from under lift-mounted vehicles or by evacuation directly from fluid reservoirs or through dipstick tubes. Steel welded tank. Includes 6 evacuation wands of various flexibility and length. Sale \$737.44  
**Tool Club \$589.95**



### LCN3601 18 Gallon Used Oil Drain

All steel design. For use with shop air. 14" telescoping bowl adjusts 45" to 72". Reinforced dispensing hose. For draining, transferring and evacuating motor oils, transmission and power steering fluids quickly. Sale \$337.44  
**Tool Club \$269.95**



### LIS11102 8 Gallon Oil Lift Drain

This specially shaped, translucent jug holds 8 gallons. Reinforced base will not warp with hot oil. Has a wide working range from 35" to 70". Large 15" funnel has strainer built-in to catch drain plugs. Base of funnel is 1 3/4" wide. Sale \$174.94  
**Tool Club \$139.95**



**Line**  
Holds  
Up To  
60 Quarts!

### LIS19202 Low Profile Truck Oil Drain

4 rollers and handle for easy transport. Cover and curved sides to keep fluids from spilling. Only 7-1/2" high. Sale \$337.44  
**Tool Club \$269.95**



### LCN3669 17 Gallon Electric Truck Drain

6' hose. Removable metal screen to catch debris. 120V electric pump. Pumps 1 gallon/minute. Easily positioned under high clearance vehicles. Used for motor oil, coolant, and transmission fluid. Overall height: 7-3/4". Sale \$649.94  
**Tool Club \$519.95**

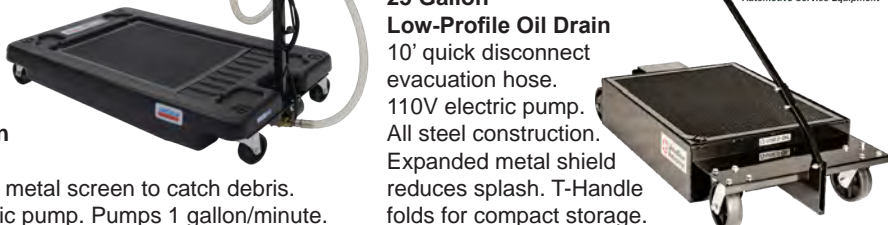

LIS17972  
4.5 Gallon Black  
Oval Oil Drain Pan  
Sale \$26.19  
**Tool Club \$20.95**



LIS17982  
4.5 Gallon Green  
Oval Oil Drain Pan  
Sale \$26.19  
**Tool Club \$20.95**



WILW4071  
4.5 Gallon Plastic  
Oil Drain Pan  
Sale \$20.63  
**Tool Club \$16.50**



LIS17922  
X-Large Drainpan  
30 quart pan with  
extended shelf.  
Sale \$64.06  
**Tool Club \$51.25**



WILW4072  
X-Large Drainpan  
7.5 gallon pan  
with extended shelf.  
Sale \$41.19  
**Tool Club \$32.95**



LIS17892  
Transpan  
Measures 22" x 23".  
Sale \$26.56  
**Tool Club \$21.25**



LIS17902  
X-Large Transpan  
38" x 24".  
Fits front wheel drive  
transmissions.  
Sale \$71.19  
**Tool Club \$56.95**



LIS19722  
24" x 36" Flat Drip Pan  
Sale \$43.13  
**Tool Club \$34.50**



JDI-18DC  
18 Gallon Self-Evacuating  
Portable Oil Drain  
Auto-Check Technology for easy  
and automatic drain evacuation.  
18-gallon steel tank.  
16" diameter funnel.  
4-caster design providing  
superior stability and mobility.  
Oil- and chemical-resistant  
3" casters for longer life.  
6' discharge hose.  
Sale \$374.94  
**Tool Club \$299.95**



JDI-LP5  
25 Gallon  
Low-Profile Oil Drain  
10' quick disconnect  
evacuation hose.  
110V electric pump.  
All steel construction.  
Expanded metal shield  
reduces splash. T-Handle  
folds for compact storage.  
6" industrial casters for easy handling & transport.  
Long-reach T-Handle makes drain easy to  
position under the vehicle.  
Sale \$999.94  
**Tool Club \$799.95**



LIS19822  
Tire Test Tank  
Sale \$84.94  
**Tool Club \$67.95**



XTS14-956  
Tire Test Tank  
Sale \$91.88  
**Tool Club \$73.50**



LIS19852  
Dual Axle Wheel Pan  
Fits in the rim recess.  
Sale \$16.56  
**Tool Club \$13.25**



KEN30600  
Professional Super  
Single Axle Drain Pan  
Keeps wheels & tires clean,  
and assures slip-free floors.  
Sale \$36.88  
**Tool Club \$29.50**



LIS38750  
15" No Splatter Pad  
Sale \$14.69  
**Tool Club \$11.75**



LIS38780  
22" No Splatter Pad  
Sale \$29.94  
**Tool Club \$23.95**



WILW1473  
32oz H.D. Spray Bottle  
Heavy duty chemical resistant sprayer  
bottle hold up to harsh cleaners and solvents.  
High output fluid nozzle that can dispense  
large volumes down to a light mist.  
Sale \$6.19  
**Tool Club \$4.95**



WILW1654C  
Pro Anti-Freeze Tester  
Precision calibrated. Color coded indicator float.  
Sale \$6.56  
**Tool Club \$5.25**



WILW1660C  
Temp Comp Anti-Freeze Tester  
Precise color coded glass float.  
Sale \$7.50  
**Tool Club \$6.00**



WILW1656C  
Deluxe Anti-Freeze Tester  
Freezing to boiling points for  
anti-freeze, calibrated in °C & °F.  
Sale \$6.56  
**Tool Club \$5.25**



WILW1657C  
Deluxe Battery Tester  
Test 6V, 12V and 24V batteries.  
Sale \$6.56  
**Tool Club \$5.25**



WILW1666C  
Battery Tester  
Color coded balls for easy readings.  
Sale \$5.63  
**Tool Club \$4.50**



EZRSP101  
Battery Hydrometer  
See the state of the battery acid.  
Sale \$12.44  
**Tool Club \$9.95**



EZRSP110  
DEF Hydrometer  
Fast & accurate. Easy to use.  
Sale \$13.69  
**Tool Club \$10.95**





**LIS58850  
Oil Pan Plug  
Rethreading Kit**

Will accurately tap a new oversize thread.  
Includes: drill, tap & 5 magnetic drain plugs.  
Sale \$160.63 **Tool Club \$128.50**



**LIS58650  
5pc Plug & Gasket  
Set for LIS58850**

Sale \$31.88 **Tool Club \$25.50**



**OIL/FUEL FILTER SOCKETS**

**LIS13270  
7pc Low Profile  
Filter Socket Set**

6pt. 24, 25, 27, 28, 29,  
32 and 36mm sockets.  
Sale \$68.69

**Tool Club \$54.95**



**LIS13300  
5pc Low Profile  
Filter Socket Set**

6pt. 24, 27, 29, 32  
and 35/36mm sockets.  
Sale \$48.44

**Tool Club \$38.75**



**LIS14500  
Ford 6.0L Diesel**

Fits 35mm and 36mm filters.  
Sale \$12.19

**Tool Club \$9.75**



**LIS14700  
Socket for GM 2.2L**

Fits 32mm filters.  
Sale \$12.19

**Tool Club \$9.75**



**LIS68210  
IPR Socket for Ford Diesel**

For Ford 6.0L.  
Sale \$34.94

**Tool Club \$27.95**



**CTA1037  
VW/Audi Oil Drain Plug**

Services 1.8L & 2.0L gas turbo  
2015 & up VW & Audi vehicles  
Sale Price \$12.44

**Tool Club \$9.95**



**CTA1320  
8pc Oil Drain Plug Kit**

For GM, Ford, Lincoln, Chrysler, Dodge, Jeep,  
Mercedes Benz, BMW, MINI, Porsche,  
VW, Audi, Mazda, Volvo, Toyota & Lexus.

Sale \$91.19 **Tool Club \$72.95**



**LIS40600  
7pc Offset  
Filter Wrench Set**

Low Profile. 3/8" Drive.  
6 point. Use on oil & fuel filter canisters.  
Size is laser marked on each wrench.

Sale \$51.56 **Tool Club \$41.25**



**OIL FILTER WRENCHES**

**KDT3941 Import & Fuel Filters**

Range: 64mm-76mm  
Sale \$27.44

**Tool Club \$21.95**

**KDT3942 Small**

Range: 73mm-83mm  
Sale \$27.44

**Tool Club \$21.95**

**KDT3943 Standard**

Range: 89mm-99mm  
Sale \$30.94

**Tool Club \$24.75**

**KDT3944 Large - Truck**

Range: 96mm-111mm  
Sale \$31.56

**Tool Club \$25.25**

**KDT2029DD  
3/8" Drive Oil  
Filter Wrench**

Range: 3-7/16" - 3-3/4"  
Sale \$18.44

**Tool Club \$14.75**

**GW GEARWRENCH**



**LIS54300 Large For Caterpillar**

Range: 5-1/4" to 5-3/4"  
Sale \$18.69

**Tool Club \$14.95**

**LIS53250 Large - Truck**

Range: 4-1/8" to 4-1/2"  
Sale \$14.38

**Tool Club \$11.50**



**LIS54200 Large -  
for Cummins & Detroit Diesel**

Range: 4-5/16" to 4-3/4"  
Sale \$17.44

**Tool Club \$13.95**



**LIS53900  
Straight Handle**

Range: 3-1/2" to 3-7/8"  
Sale \$11.88

**Tool Club \$9.50**



**LIS54400 Import & Fuel Filters**

Range: 2-3/8" to 2-5/8"  
Sale \$13.13

**Tool Club \$10.50**



**LIS53700 Small**

Range: 2-7/8" to 3-1/4"  
Sale \$14.38

**Tool Club \$11.50**

HANDLE  
SWIVELS  
TO CLEAR  
OBSTRUCTIONS

**LIS53500 Standard**

Range: 3-1/2" to 3-7/8"  
Sale \$14.38

**Tool Club \$11.50**



**GW GEARWRENCH**

Includes a 1-1/2"  
wide band and a 1/2"  
square drive opening.

Part #	Capacity	Sale	Club
KDT2320D	4-1/8" to 4-21/32"	\$35.63	\$28.50
KDT2321	4-21/32" to 5-5/32"	\$37.44	\$29.95
KDT2322D	5-5/32" to 5-21/32"	\$37.44	\$29.95

**DISCONNECT TOOLS**



**LIS39850  
Master Plus Disconnect Set**

Most popular disconnect tools in one case.  
Includes fuel line quick connect & spring lock  
couplings, air conditioning line couplings, &  
transmission oil cooler connectors.  
Sale \$186.88 **Tool Club \$149.50**



**LIS39900  
Disconnect Set**

Fits A/C, fuel,  
heater and transmission lines.  
Sale \$68.69 **Tool Club \$54.95**



**LIS37000  
A/C, Fuel, &  
Transmission Line  
Disconnect Tool**

For 5/16", 3/8", 1/2",  
5/8", 3/4", & 7/8" lines.  
Sale \$11.88

**Tool Club \$9.50**



**LIS39400  
Angled Disconnect Set**

5/16", 3/8", 1/2", 5/8", 3/4" &  
7/8". Fits A/C and fuel lines.  
Angled to fit in tight spaces.

Sale \$21.25 **Tool Club \$17.00**

**DSIQRP4S  
4pc Quick  
Release  
Pliers Set**

Small and large angle.  
Small & large vertical pliers.  
Sale \$249.94 **Tool Club \$199.95**



**LIS39220  
3/8" & 1/2"  
Disconnect Set**

Sizes: 3/8" for  
2003 and later Ford V8 Explorer, 2004  
and later Ford F150 and Cadillac CS.  
1/2" size for Ford Super Duty trucks,  
F250, F350 and F450.

Sale \$30.31 **Tool Club \$24.25**



**LIS39960  
Transmission  
Disconnect Set**

Sizes: 3/8" & 1/2" for Ford Explorer,  
F150, F250, F350, F450 & Cadillac CS.  
Sale \$12.44 **Tool Club \$9.95**

**CTA7420  
Ford ATF Filler Adapter**

Use with Suction Gun to fill or add  
fluid to the 5R55W. Automatic  
Transmission on '03 & up Ford.  
Sale \$14.94 **Tool Club \$11.95**

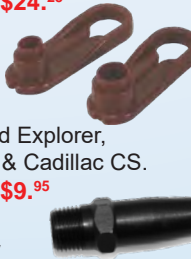



**LIS61460**  
**21pc H.D. End Cap Wrench Set**  
 84mm - 14 flutes; 76mm - 15 flutes  
 93mm - 45 flutes; 82mm - 15 flutes  
 80mm - 15 flutes; 76mm - 14 flutes  
 93mm - 36 flutes; 86mm - 14 flutes  
 96mm - 18 flutes; 76mm - 30 flutes  
 100mm - 15 flutes; 74mm - 15 flutes  
 90mm - 15 flutes; 73/74mm - 14 flutes  
 65/67mm - 14 flutes; 74/76mm - flutes; & more!  
 Sale \$162.44 **Tool Club \$129.95**

**LIS61450**  
**10pc Cap Wrench Set**  
 65/67mm - 14 flutes; 68mm - 14 flutes  
 74/76mm - 15 flutes; 76mm - 14 / 30 flutes  
 80mm - 15 flutes; 86mm - 16 flutes  
 93mm - 15 / 36 flutes; 100mm - 15 flutes  
 Sale \$94.94 **Tool Club \$75.95**

**CHAIN WRENCHES**



Part #	Range	Sale	Club
OTC6968	1/2" - 4-1/2"	\$55.63	<b>\$44.50</b>
OTC6969	3" - 6-1/2"	\$108.69	<b>\$86.95</b>

**TOYOTA / LEXUS**

**CTA2460**  
 Toyota / Lexus / Scion  
 64mm x 14 Flutes.  
 Sale \$19.06 **Tool Club \$15.25**

**CTA2485**  
 Toyota / Lexus  
 Oil Filter Wrench  
 64mm x 14 Flutes.  
 Sale \$12.44 **Tool Club \$9.95**

**CTA2465**  
 4-1 Oil Filter Cap Wrench  
 64mm x 14 flute Fits all four  
 styles of Toyota, Lexus and Scion  
 Sale \$33.44 **Tool Club \$26.75**

**CTA2475**  
 Toyota / Lexus HD Steel Oil  
 Filter Wrench  
 64mm x 14 flutes.  
 Sale Price \$43.13  
**Tool Club \$34.50**

**CTA2477**  
 Toyota / Lexus  
 Oil Filter Wrench  
 64mm x 14 flutes.  
 Slim design.  
 Sale \$34.69  
**Tool Club \$27.75**

**CTA2487**  
 Hyundai / Kia HD Oil Filter Wrench  
 88mm x 15 Flutes  
 Sale \$12.44  
**Tool Club \$9.95**

**CTA2489**  
 Volvo HD Oil Filter Wrench  
 86mm x 16 Flutes  
 Sale \$12.44 **Tool Club \$9.95**

**CTA2505**  
 HD Spider Type  
 Oil Filter Wrench  
 3/8" drive. Range: 61 - 121mm.  
 Sale \$29.38  
**Tool Club \$23.50**

**CTA2507**  
 Bi-Directional  
 Spider-Type Oil  
 Filter Wrench  
 3/8" & 1/2" square drive  
 & adapters w/ hex.  
 Range: 50 to 95mm.  
 Sale \$21.88  
**Tool Club \$17.50**

**KDT3288D**  
 3-Jaw Adjustable  
 Filter Wrench  
 Range 2-1/2" to 3-3/4"  
 Sale \$21.88  
**Tool Club \$17.50**

**LIS63600**  
 Adjustable Filter Wrench  
 Range: 2-1/2" to 3-1/8"  
 Sale \$14.94  
**Tool Club \$11.95**

**LIS63250**  
 Adjustable Filter Wrench  
 Range: 3-1/8" to 3-7/8"  
 Sale \$15.63  
**Tool Club \$12.50**

**LIS60200**  
 HD Strap Filter Wrench  
 Remove or install filters &  
 objects up to 6-1/2" in diameter.  
 Sale \$31.19  
**Tool Club \$24.95**

**KDT3529D**  
 H.D. Strap Wrench  
 Handles filters up to 9" diameter.  
 Sale \$47.44  
**Tool Club \$37.95**

**LIS28500**  
 Strap Wrench  
 Loosen or tighten any shaped  
 object. Range 1" to 6-5/8"  
 Sale \$28.75  
**Tool Club \$23.00**



**OIL FILTER PLIERS**

**VIMV2400G**  
 Auto Adjusting  
 Locking Oil Filter Pliers  
 Size: 8"x6"x1"  
 Sale \$54.94  
**Tool Club \$43.95**



**LIS50750**  
 Angled Oil Filter Pliers  
 Range: 2-1/4" to 4" 20° offset.  
 Sale \$44.06  
**Tool Club \$35.25**



**LIS50950**  
 Large Oil Filter Pliers  
 For trucks.  
 Range: 3-5/8" to 6".  
 Sale \$57.81  
**Tool Club \$46.25**



**CL212**  
 12" Pliers  
 Opens to 4-1/4".  
 Sale \$30.31  
**Tool Club \$24.25**



**CL215**  
 XL 15.5" Pliers  
 Opens to 5-1/2".  
 Sale \$35.63  
**Tool Club \$28.50**

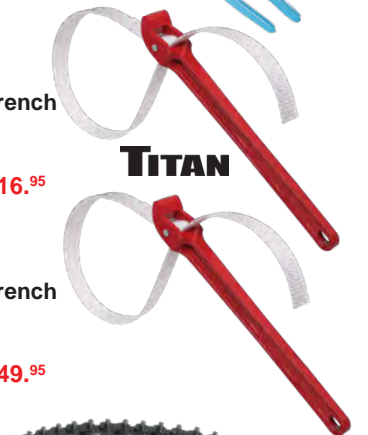

**TIT21315**  
 12" Strap Wrench  
 36" strap.  
 Sale \$21.19  
**Tool Club \$16.95**

**TIT21316**  
 18" Strap Wrench  
 27" Strap.  
 Sale \$62.44  
**Tool Club \$49.95**

**TIT21370**  
 12" Chain Wrench  
 Pipe Capacity: 2"  
 Sale \$33.13 **Tool Club \$26.50**

**TIT21372**  
 24" Chain Wrench  
 Pipe Capacity: 3"  
 Sale \$56.19 **Tool Club \$44.95**

**CTA4326**  
 6pc Oil Filter Wrench Set  
 CTA 2538: 57mm - 73mm  
 CTA2540: 65mm - 83mm  
 CTA2545: 75mm - 95mm  
 CTA2548: 92mm - 111mm  
 CTA2552: 100mm - 120mm  
 CTA2551: 120mm - 146mm  
 Sale \$99.94 **Tool Club \$79.95**





**NEW!**



**MSC43050**  
**15pc Air Powered Brake Caliper Wind Back Tool Kit**  
 Left or right wind-back operation. Pneumatic single piston press shaft operation allows one technician to perform the brake job.  
 Sale \$217.81 **Tool Club \$174.25**

**LIS25000**  
**Disc Brake Piston Tool Set**



Includes 5 adapters for use in 2 and 4 wheel rear disc brake assemblies.  
 Sale \$104.69  
**Tool Club \$83.75**

**AST78619**  
**18pc Brake Caliper Wind Back Tool Set & 8pc Professional Brake Tool Set**

Complete set of adaptors for push & wind back brake pistons. For both left & right handed thrust bolt assemblies. Prevents damaging pistons and seals.  
 Sale \$103.13  
**Tool Club \$82.50**



**AST78618**  
**18pc Brake Caliper Wind Back Tool Set**

Complete set of adaptors for push & wind back brake pistons. For both left & right handed thrust bolt assemblies. Prevents damaging pistons and seals.  
 Sale \$59.06  
**Tool Club \$47.25**



**BI-DIRECTIONAL**

**CTA1458**  
**3 Pin Brake Piston Wind Back Adapter**



Use with 3/8" square drive tools. For use with late model VW, Audi, & BMW with Electomechanical Parking Brakes (EPB).  
 Sale \$16.88 **Tool Club \$13.50**

**CAL723**  
**Brake Caliper Turn Back Tool**

Rotates brake pistons back into the caliper on vehicles with self adjusting parking brakes. Universally adjustable 2 and 3 pin configurations takes place of many kits.  
 Sale \$62.44 **Tool Club \$49.95**



**CAL724**  
**Brake Rewind Adapter Set**

Adjustable 2 & 3 pin piston wind back tool. For vehicles with self adjusting parking brakes. Fits most vehicles.  
 Sale \$46.88 **Tool Club \$37.50**



**NEW!**

**VIMBB500**  
**Brake Bleeder Wrench Set**



Sizes: 7mm - 11mm. Double bends for easy access. Angles are designed to access bleeder screws without removing the wheel.  
 Sale \$62.44 **Tool Club \$49.95**

**LIS10900**  
**5/16" X 3/8" Brake Bleeder Wrench**



For 5/16" or 3/8" bleeder screws.  
 Sale \$10.31 **Tool Club \$8.25**

**LIS10990**  
**7mm/9mm Brake Bleeder Wrench**



Offset for easy access to hard-to reach bleeder screws.  
 Sale \$10.31 **Tool Club \$8.25**

**LIS10950**  
**Brake Bleeder 1/4 X 3/8**



For 1/4" or 3/8" bleeder screws.  
 Sale \$10.31 **Tool Club \$8.25**

**LIS11000**  
**8mm/10mm Brake Bleeder Wrench**



Offset for easy access to hard-to bleeder screws  
 Sale \$10.31 **Tool Club \$8.25**

**TA17380**  
**Disc Brake Caliper Brush**



For removal of brake dust and dirt from the caliper shaft. The thin profile easily accesses narrow crevices, and each brush has an angled head for better access, as well as heavy duty steel bristles  
 Sale \$10.63 **Tool Club \$8.50**

**LIS13410**  
**Brake Caliper Brush**



Angled HD Steel wire brush for tight spaces.  
 Sale \$10.94 **Tool Club \$8.75**

**LIS44210**  
**Universal Emergency Brake Tool**



Compresses the emergency brake cable with one hand.  
 Sale \$29.94 **Tool Club \$23.95**

**LIS81850**  
**Brake Lining Thickness Gauge**



Checks straight and at 90°  
 SAE: 0.0787" - 0.4724"  
 Metric: 2mm - 12mm  
 Sale \$26.88 **Tool Club \$21.50**

**KDT3962**  
**Brake Lining Thickness Gauge**



SAE: 0.0787" - 0.4720"  
 Metric: 2mm - 12mm  
 Sale \$31.56 **Tool Club \$25.25**

**LIS71020**  
**12pc Master Brake Kit**

Includes tools for removing and installing brake springs along with parking brake, star wheel adjusting tools and brake lining gauges. Includes carrying bag.  
 Sale \$212.44 **Tool Club \$169.95**

**AST7848**  
**8pc Brake Tool Set**

Includes spring tools, adjusting spoons & mini adjusting spoon.  
 Sale \$50.94 **Tool Club \$40.75**

**LIS48020**  
**Brake Caliper Hanger Set**

Hangs the disc brake caliper out of the way during service while keeping tension off the brake line.  
 Sale \$10.63 **Tool Club \$8.50**

**TITAN**

**NEW!**

**TIT51600**  
**Brake Caliper Hanger Set**

Securely holds exhaust systems. Made from 1/4" Heavy Duty Steel.  
 Sale \$9.38 **Tool Club \$7.50**

**LIS45100**  
**Brake Spring Tool**

For return springs that don't use an anchor pin.  
 Sale \$14.38 **Tool Club \$11.50**

**LIS47400**  
**Brake Spring Tool**

Fits large and small retaining washers.  
 Sale \$9.94 **Tool Club \$7.95**

**LIS48400**  
**Import Brake Clip Tool**

For the hold down clips on brake shoes.  
 Sale \$15.63 **Tool Club \$12.50**

**LIS44800**  
**H.D. Brake Spring Tool**

For larger return springs with or without an anchor pin.  
 Sale \$19.94 **Tool Club \$15.95**

**LT890**  
**Truck Brake Spring Tool**

Slotted ends hold spring at correct work angle.  
 Sale \$64.38 **Tool Club \$51.50**

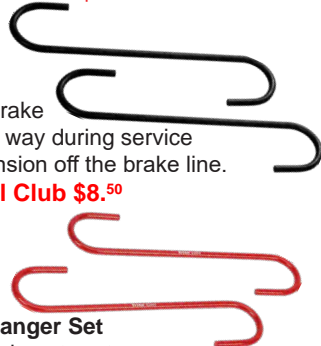

# BRAKE PAD SPREADERS

**LANG279**  
**Brake Caliper Press**  
 360° ratchet swing.  
 Prevent misalignment of pistons.  
 For single, dual, & quad piston calipers.  
 Sale \$71.19 **Tool Club \$56.95**



**LANG277**  
**Small Brake Caliper Press**  
 Works on small & medium  
 piston brake calipers. Size range: 1" - 3"  
 Sale \$64.06 **Tool Club \$51.25**



**AST78610**  
**Brake Caliper  
 Spreader Press**  
 360° ratchet swing.  
 Prevent misalignment of pistons.  
 For single, dual, & quad piston calipers.  
 Sale \$52.44 **Tool Club \$41.95**



**LIS29350**  
**Combination  
 Disc Brake Kit**  
 Designed to work on  
 single piston disc brakes  
 that require the piston to be  
 rotated back into the caliper as  
 well as pistons that are not rotated.  
 Includes various adapters.  
 Sale \$144.06 **Tool Club \$115.25**



**LIS29100**  
**Quick Quad Pad Spreader**  
 Simultaneously compress all four  
 pistons on quad piston applications.  
 Sale \$84.38 **Tool Club \$67.50**



**LIS25750**  
**Dual Piston  
 Brake Pad Spreader**  
 Specially designed  
 for dual piston calipers.  
 Sale \$66.19 **Tool Club \$52.95**



**LIS24300**  
**Speedy Brake  
 Pad Spreader**  
 Fast acting plunger compresses  
 disc brake pistons in seconds.  
 Sale \$54.06 **Tool Club \$43.25**



**LIS24400**  
**Disk Brake Pad Spreader**  
 Sale \$13.69 **Tool Club \$10.95**

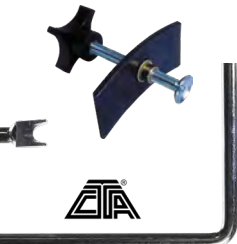

**CTA1437**  
**VW/Audi Brake  
 Release Tool**  
 Special bends allows  
 separation of the brake servo push rod from the  
 brake pedal. VW/Audi models 2008 and newer  
 Sale \$49.94 **Tool Club \$39.95**



**CTA5035**  
**5pc VAG Brake  
 Caliper Socket Set**  
 Services many VW/Audi group vehicles.  
 Includes VAG Brake Caliper Socket 7pt. Small, 7pt. Large,  
 10pt. X 11.5mm, 10pt. X 15mm & 10pt. X 20mm.  
 Sale \$81.88 **Tool Club \$65.50**



# FLARING TOOLS



**MSC72485-PRC**  
**Universal Hydraulic Flaring Tool Set**  
 This kit fabricates Push Connect 1/4, 5/16  
 and 3/8"; GM Fuel Line Flare, Brake Lines and  
 Transmission 5/16 and 3/8"; Flare/Double Flare  
 3/16, 1/4, 5/16, 3/8 and 1/2"; Metric Bubble  
 Flare 4.75, 6, 8, and 10mm.  
 Sale \$474.94 **Tool Club \$379.95**



**KDT41880D**  
**Combination Flaring Tool**  
 Works on single and double flares 3/16"  
 to 1/2", 6 & 10mm, plus ISO (Bubble)  
 flares 4.7 to 10mm. Includes tubing cutter.  
 Sale \$166.88 **Tool Club \$133.50**



**KDT41870**  
**I.S.O. Flaring Tool Set**  
 Forms bubble flares on  
 4.75, 6, 8, & 10mm tubing.  
 Sale \$109.94 **Tool Club \$87.95**



**KDT41860**  
**Double Flaring Tool Set**  
 Forms double flares on 3/16", 1/4",  
 5/16", 3/8", 7/16", 1/2", & 5/8" tubing.  
 Sale \$96.19 **Tool Club \$76.95**

# TUBING TOOLS



**LIS44150**  
**3/16" Tubing Bender Pliers**  
 For 3/16" tubing. Designed for tight spaces.  
 Sale \$40.31 **Tool Club \$32.25**



**LIS44070**  
**1/4" Tubing Bending Pliers**  
 Bends 1/4" brake lines without  
 kinking or flattening in tight spots.  
 Sale \$41.19 **Tool Club \$32.95**



**CTA5027**  
**Audi Brake Caliper  
 Socket 7PT Large**  
 Used for Audi S4  
 and S5 Models.  
 Sale \$23.13 **Tool Club \$18.50**



**CTA5025**  
**Audi Brake Caliper  
 Socket 7PT Small**  
 Used for Audi Q7, S5 and  
 Various Mercedes Benz models  
 Sale \$23.13 **Tool Club \$18.50**



**CTA7394**  
**18pc Brake Caliper Socket Set**  
 Features the newest & most commonly used  
 caliper sockets for most makes & models.  
 Services Domestic, Euro & Asian vehicles  
 Sale \$137.44 **Tool Club \$109.95**



**KDT2517D**  
**Tubing Bender**  
 For 3/16", 1/4", 5/16" & 3/8" OD tubing.  
 Sale \$21.19 **Tool Club \$16.95**



**WILW705**  
**2-in-1 Ratcheting Pipe Cutter**  
 Quick release handle allows cutter to switch  
 quickly from ratcheting to compact cutter.  
 Adjusts to fit pipe or tubing anywhere from  
 1/4"-1-1/8" (6mm-28mm).  
 Sale \$34.38 **Tool Club \$27.50**



**TIT11489**  
**180° Tubing Bender**  
 Radius bends up to 3/8" & 180°  
 max. Calibration gauge.  
 Sale \$29.38 **Tool Club \$23.50**



**TIT11488**  
**Tube Bending Pliers**  
 For soft thin wall tubing.  
 3/16", 1/4", 5/16" & 3/8"  
 OD tubing.  
 Sale \$20.31 **Tool Club \$16.25**



**KDT2107D**  
**Mini Tubing Cutter**  
 Capacity 1/8" to 5/8".  
 Sale \$12.19 **Tool Club \$9.75**



**TIT11490**  
**Mini Tubing Cutter**  
 Capacity 1/8" to 7/8".  
 Sale \$11.56  
**Tool Club \$9.25**



**TIT11491**  
**Tubing Cutter**  
 Capacity 1/8" to 1-3/8".  
 Sale \$35.63 **Tool Club \$28.50**

BRAKE TOOLS

LIS19912

**Multi-Application Oil Funnel - 14pc Set**

Helps eliminate oil spills when refilling crankcases. 1.6 qt funnel with 14 color-coded adapters and a 45° elbow. Sale \$74.94 **Tool Club \$59.95**



LUMLX1706

**6 Qt. Galvanized Steel Funnel**

Grooved spouts for air-venting. Fluted bottom to prevent swirling. Fine-mesh S.S. strainer. Sale \$28.13 **Tool Club \$22.50**



WILW1145

**Multi-Use Transfer Pump**

Quickly and easily transfers any fluid. Can be used as an air pump — inflation needle not included. Sale \$16.56 **Tool Club \$13.25**



**HAND PUMPS**

ALL PUMPS FIT 30-55 GALLON DRUM

PL55123

**H.D. Barrel Pump**

2pc. telescoping suction tube with garden hose thread discharge spout, standard bung adapter, and all-steel foot and piston valves. Dispenses approx. 10 oz./stroke. Sale \$69.69 **Tool Club \$55.75**



PL55017

**Pull Up Barrel Pump**

Die cast head with garden hose threads and 18 gauge steel cylinder. Includes curved metal spout & adapter. Sale \$56.19 **Tool Club \$44.95**



LUMLX1300

**Lever Action Bucket Pump**

For all types of fluids. Perfect for cold weather. Clamps to any 25 - 50lb / 5 gallon pail. Sale \$54.94 **Tool Club \$43.95**



PL55125

**Professional Barrel Pump**

Lever style with non-drip spout. Pumps all lubrication based fluids, antifreeze and oil. Dispenses approx. 12oz./stroke. Sale \$84.94 **Tool Club \$67.95**



LUMLX1316

**Lever Action Barrel Pump**

For transfer of non-corrosive fluids. Fits 15 - 55 gallon drums. Delivers 13 oz per stroke. Sale \$61.19 **Tool Club \$48.95**



LIS18232

**Offset Funnel w/ Spout Cap & Lid**

10" tall translucent funnel with a 6-3/4" offset from center of mouth to center of spout. Includes lid and spout cap to keep contaminants out. Includes adapter for transmissions and dipstick tubes. Sale \$19.38 **Tool Club \$15.50**



NPG18609

**Flexible Form-A-Funnel 14.5"L x 6.5"W**

Funnel can be molded to fit almost any shape needed. Works in -30° - 450° F. Sale \$33.13 **Tool Club \$26.50**



LUMLX1704

**12" Flex Pipe & Screen**

Galvanized funnel for adding transmission fluid. 1-1/2 Qt. capacity. 12" Flex metal spout with fine mesh. Sale \$18.13 **Tool Club \$14.50**

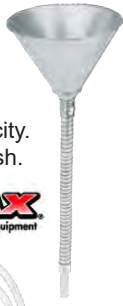

LUMLX1344

**Hand Transfer Pump**

Pumps most non-corrosive fluids. 8 ft. hose. 1 Gallon per 8 strokes. Sale \$39.69 **Tool Club \$31.75**



PL55303

**Rotary Barrel Pump**

For transferring non-corrosive petroleum-based fluids of light to medium viscosity. Transfers 1 gal./18 revs. with SAE 10 oil. Sale \$145.31 **Tool Club \$116.25**



LUMLX1320

**HD Barrel Pump**

Fits 15-55 Gal. Drums with 2" Bung Opening. For light to medium viscosity. 40" Corrosion-resistant suction tube. Self priming. Sale \$92.44 **Tool Club \$73.95**



PL55-155

**DEF Rotary Barrel Pump**

Fits all 15-55 gallon drums with standard bung. Delivers 7 gallons per 100 revolutions. Sale \$187.44 **Tool Club \$149.95**



AFF8055

**DEF Barrel Pump**

Fits all 15-55 gallon drums. Pump can be used as a siphon. Delivers 1 pint per stroke. 2" bung adapter. Sale \$162.44 **Tool Club \$129.95**



LIS19732

**6qt Oil Dispenser**

With flexible 8" spout. Sale \$23.13 **Tool Club \$18.50**



LIS19702

**8qt Oil Dispenser With Lid And Cap**

Sale \$29.94 **Tool Club \$23.95**



LIS17232

**Right Angle Funnel**

10" tall. 6-3/4" offset from center of mouth to center of spout for hard to reach areas. Sale \$13.75 **Tool Club \$11.00**



LIS19802

**Threaded Oil / Transmission Funnel**

Two piece design can be used separately or together. Sale \$10.94 **Tool Club \$8.75**



LUMLX1609

**32oz, 2pc Funnel with Flex Spout**

Flexible spout is threaded to screw onto most oil containers. Sale \$6.24 **Tool Club \$4.99**



LUMLX1614

**48 oz. Long Neck Funnel**

All purpose utility funnel. X-Long neck, for hard-to-reach spots. Sale \$6.24 **Tool Club \$4.99**



WILW4034

**18" Funnel**

Extra long neck prevents spills. Sale \$6.19 **Tool Club \$4.95**



LIS19832

**1.6qt Plastic Funnel with Lid and Spout Cap**

Translucent color allows you to see the fluid inside the funnel. Sale \$17.19 **Tool Club \$13.75**



TIT19426

**Refillable Aluminum Spray Bottle**

CFC-free, re-usable aluminum spray bottle. Includes 55mm jet nozzle and spray nozzle. Maximum Pressure: 116PSI Maximum capacity: 7.7oz. Sale \$64.94 **Tool Club \$51.95**



**TITAN**

TIT19419

**Spot Spray Non-Aerosol Sprayer**

80-150psi operating pressure (max pressure: 200 psi). Maximum capacity: 32oz. Sale \$51.19 **Tool Club \$40.95**





## TIRE PRESSURE MONITORING SYSTEMS

### BARTECH600PRO Tech600Pro Kit

- High resolution color display.
  - Wireless Vehicle Connection (VCI).
  - Long lasting, rechargeable battery.
  - Improved LF Signal & UHF Detection.
  - Faster tool response & operation.
  - Functions include: Wi-Fi updating, Rite-Sync®, VINDicate® & Placard Adjusting.
  - Includes 2 Year Warranty with 2 years of software updates!
- Sale \$1,618.75 **Tool Club \$1,295.00**



### XTS17-43800 Smart Sensor Elite Bundle

- Features easy to navigate with icon based interface, WiFi & Bluetooth enabled, 3.5" color display, comprehensive relearn procedures built into the tool, TPMS placard adjusting, Wireless updates, VIN code scanner, capture TIN, & print TPMS & VIN/TIN data via PC. Includes Tool, Micro USB data cable & charger, OBDII Cable, 16 sensors & TPMS activation magnet.
- Sale \$618.75 **Tool Club \$495.00**



### ATLITS600 Complete TPMS Service And Diagnostics Tablet

- Activates, reads and relearns all known sensors. Four MX-Sensor program modes. Batch program up to 20 MX-Sensors. Read/Erse all system codes and perform OLS, BMS, SAS and EPB.
- Sale \$624.94 **Tool Club \$499.95**



### ATLTS408 TPMS Service Tool

- Easy-to-use Handheld TPMS Service tool
  - Activates all known TPMS Sensors
  - Reads sensor ID, Tire pressure, Battery Life
  - Programs MX-Sensors to replace OE Sensors
  - Free Software Updates
- Sale \$199.94 **Tool Club \$159.95**



### ATLTBE200 Laser-Enabled Tire Tread and Brake Disc Wear Examiner

- 1.65" AMOLED super retina touchscreen display. Full color graphical display illustrates wear. 4MP 4cm Macro camera & 8MP zoomable camera to document tire damage. Scan TIN. 3000mAh Lithium-Ion battery.
- Sale \$487.44 **Tool Club \$389.95**



**XTS17-43042  
Smart Sensor  
Multi-Frequency  
TPMS Sensor**  
Combines 314.9MHz, 315MHz, and 433.92MHz  
All in ONE Sensor.  
Sale \$33.69 **Tool Club \$26.95**



### AUTEL® ATL1SENSOR MX-SENSOR

Combines both 315MHz + 433MHz frequencies into one TPMS sensor. Weighs only 12g. Meets SAE industry standard J1205 / J1206 testing. Can be programmed wirelessly, even when already mounted to the wheel.  
Sale \$36.88 **Tool Club \$29.50**



### LIS19860 Tire Deflator Set

For TPMS Valve Stems. Evacuates air from tires without removing valve core.  
Sale \$21.88 **Tool Club \$17.50**



### LIS18810 Tire Valve Stem Torque Tool

Preset to 4 in/lb.  
Sale \$31.88  
**Tool Club \$25.50**



### LIS14100 X-Long Valve Core Tool

Double ended, fits both large & regular valves.  
Sale \$16.56  
**Tool Club \$13.25**



### LIS68130 Wheel Weight Tool

Sale \$34.94  
**Tool Club \$27.95**



### KDT3358 Wheel Weight Tool

Sale \$51.88  
**Tool Club \$41.50**



### LIS22800 Wheel Stud Installer

Sale \$37.44  
**Tool Club \$29.95**



### LIS28950 Truck Wheel Stud Installer

Fits up to 22mm (7/8").  
Sale \$44.06  
**Tool Club \$35.25**



## PATCHES



Black vulcanizing gum blue poly backing. Designed for chemical vulcanization.

Part #	Size	Qty	Sale	Club
XTS11-306	1-3/4"	50	\$24.06	<b>\$19.25</b>
XTS11-308	2-1/8"	25	\$19.94	<b>\$15.95</b>
XTS11-310	3"	15	\$22.44	<b>\$17.95</b>

## TIRE REPAIR



### BJKT340 Professional H.D. Tire Repair Kit

T-Bone Handles with spiral probe & open eye needle, spare 4" open eye needle, screwdriver with reversible shaft & valve core tool, hex wrench, specially formulated lube, razor blade & 40 repairs.  
Sale \$69.38 **Tool Club \$55.50**



### AST7445 45pc Tire Repair Kit

Includes T-handle insert tool & spiral probe, (40) 4" repair strings & lubricant.  
Sale \$29.38  
**Tool Club \$23.50**



### XTS12-353 Power-X String Tire Repair Kit - 4"

Pistol grip HD handles. Extra-thick repair inserts.  
Sale \$62.44  
**Tool Club \$49.95**



### XTS12-354 Power-X String Tire Repair Kit - 8"

Sale \$90.63  
**Tool Club \$72.50**



### XTS14-219 H.D. Composite Pistol Grip Needle

Sale \$29.94  
**Tool Club \$23.95**



### XTS14-320 2.5" Light Duty Carbide Buffing Wheel

Sale \$8.69  
**Tool Club \$6.95**



### XTS14-314 3/16" x 1.5" Wood Handle Stitcher

Sale \$10.94  
**Tool Club \$8.75**



### BJ460 60pc Tire Repair String

4" Large Diameter  
Sale \$28.75  
**Tool Club \$23.00**



### XTS12-361 Fat Brown String Inserts - 4" (50pk)

Sale \$10.63  
**Tool Club \$8.50**

### XTS12-362 Fat Brown String Inserts - 8" (50pk)

Sale \$10.63  
**Tool Club \$8.50**



## INSPECTION CAMERAS

### AUTEL

#### ATLMV208-55 MaxiVideo Digital Video Scope w/ 8.5mm Probe

Records and plays back still images and video clips. 2.4" high resolution full color LCD display (320x240). Wide camera angle for images with 640x480 resolution. On-screen horizontal/vertical reverse. 5x digital zoom for increased viewing. Sale \$174.94 **Tool Club \$139.95**



**CAL84  
WiFi Boroscope**  
High resolution, multiple aspect camera (1080p, 720p & 480p). Adjustable LED lighting. Independent WiFi signal. Connect to the mobile app for both Android & iOS. Sale \$93.69 **Tool Club \$74.95**



### AUTEL

**NEW!**

#### ATLMV400-55 Maxivideo™ Digital Inspection Scope

3.5" High Resolution full color LCD Display. Record & play back images & video clips. Save images & videos to internal memory or SD Card. 5x zoom. Oil & scratch resistant tempered glass camera lens. Rugged 1 meter flexible watertight camera cable. Built-in white LED. Up to 6 hours of continuous use. Sale \$224.94 **Tool Club \$179.95**



#### ULLE-DM-1 Rechargeable Digital Inspection Camera

Bluetooth-enabled 720p Camera w/ LED illumination for pictures & videos! Connect to your phone/tablet through the Ullman DM App! Dual point 360° rotational knuckle to see behind, under and around objects! Sale \$99.94 **Tool Club \$79.95**



VIEW FROM YOUR PHONE!  
**ULLMAN**

#### ATLMV480 MaxiVideo Digital Inspection Videoscope

Record/Playback high resolution images & videos (1080p). Dual front and side cameras. 4.1" color LCD display. New audio annotation function. Bright LED flashlight on the back of the handle. Up to 4 hours run time. Sale \$449.94 **Tool Club \$359.95**



**AUTEL**

#### ULLE-CART-1 CART™ Camera Retrieval Tool

Retractable, sturdy, four-pronged pick-up claw. Four LED lights with six brightness levels. Magnet with 4lb. pull force allows for easy retrieval of ferrous objects. 32" long bendable arm. 480p camera shows live footage. IP67 dustproof & waterproof camera head. Four AA batteries included. Sale \$119.94 **Tool Club \$95.95**



**ULLMAN**

## THERMOMETERS

#### MSC52224A Laser Infrared Thermometer

Range: -58 to 932°F. Laser targeting accuracy. Includes analog thermometer. Sale \$86.88 **Tool Club \$69.50**



#### MSC52225-MED Multi-Function Medical/Surface Infrared Thermometer

Range: -7.6°F - 176°F. Fever alarm detects temperature greater than 99.5°F under forehead mode. Easily switch between °F & °C. Large backlit LCD for easy reading. Sale \$93.69 **Tool Club \$74.95**



#### TITAN TIT51408 High Temp Infrared Thermometer

Range: -58°F ~ 1202°F. Laser targeting accuracy. Sale \$41.19 **Tool Club \$32.95**



## THERMAL IMAGING

#### MLW2257-20 102 x 77 Spot Infrared Imager

Instant start-up. Take temperature measurements from long range or up close with 56:1 distance-to-spot performance. Iron bow color palette. Toggle between °F and °C measurements with switch in the battery compartment. Powered by a standard 9-Volt Alkaline battery. Sale \$624.94 **Tool Club \$499.95**



#### IPA8027 6-Way Round Pin Towing Maintenance Kit

Quickly test, clean & repair truck and trailer connections. Tests tractor electrical circuits. For use with 6-way round connectors. Sale \$41.19 **Tool Club \$32.95**



#### IPA9107A Electric Brake Force Meter

Dynamic load simulation & circuit testing. For use on 7-Way Flat (Spade) equipped vehicles. Meeter displays real-time brake controller output gain & timing. For use with integrated & aftermarket trailer brake controllers. Can troubleshoot truck-side tow circuits, 12V+, reverse & ground condition and the 25ft cable allows for one-man, in-cab testing. Sale \$233.69 **Tool Club \$186.95**



#### IPA9101 Light Ranger MUTT 7-Way Spade Pin

Portable & water resistant trailer light & brakes tester. Circuit protection. Turn signal simulation & power verification LED. 500mA battery charger & 3-Way trailer adapter included. Internal battery compartment (battery not included). For 7-way spade, 6-way round & 4/5 pin trailer harnesses. Sale \$233.69 **Tool Club \$186.95**



#### IPA8028 7-Way Flat (Spade) Pin Towing Maintenance Kit

Quickly test, clean & repair truck and trailer connections. Tests tractor electrical circuits. For use with 7-way flat (spade) connectors. Sale \$53.44 **Tool Club \$42.75**



#### IPA8048 Terminal Maintenance Set

Set cleans & repairs almost every type of electrical connectors found on cars, trucks & industrial equipment. Used as both a service & preventative maintenance tool for Deutsch, Cannon, 7 round pin trailer harnesses & more! Sale \$157.81 **Tool Club \$126.25**

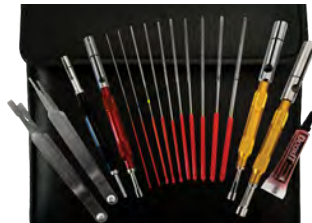

#### IPA9102 Heavy Ranger MUTT® 7-Way Round Pin

Commercial Trailer light and brakes tester. Short circuit protection. Water resistant. Turn signal & power verification LED. Internal battery compartment (battery not included). External 12V power port. Includes 500 mA battery charger. Sale \$233.69 **Tool Club \$186.95**



#### IPA8029 7-Way Round Pin Towing Maintenance Kit

Test, clean and restore male and female 7-way round pin connectors and terminals. For use with 7-way round connectors. Sale \$73.13 **Tool Club \$58.50**





**PP319FTC  
POWERPROBE3 Tester**

With a built-in voltmeter. Works with all systems up to 42 volt. Built-in banana jack for accessories. Kit included & adapters. Sale \$174.94 **Tool Club \$139.95**



**PP3CS  
POWERPROBE 3 Circuit Tester - TOOL ONLY**

Supplies Power & Ground. Digital Voltmeter with Min/Max Voltage Capturing. 4mm banana jack. 20 Foot power lead. Tests for Bad Grounds and Continuity. 8 Amp Circuit Breaker Protection. Sale \$143.69 **Tool Club \$114.95**



**PP3EZ  
POWERPROBE 3EZ Kit**

Test voltages and power up components on and off the vehicle. EZ Learning software, teaches the user how to operate the tool. EZ Diagnostics software, teaches the user how to perform common diagnostic applications on a vehicle. Menu driven navigation. Packaged in case with a cigarette adapter and a 20 ft. extension cord. Sale \$201.88 **Tool Club \$161.50**



**PP3EZCS  
POWERPROBE 3EZ Tool Only**

Test voltages and power up components on and off the vehicle. EZ Learning software, teaches the user how to operate the tool. EZ Diagnostics software, teaches the user how to perform common diagnostic applications on a vehicle. Menu driven navigation. Sale \$174.94 **Tool Club \$139.95**



**PPIV  
POWERPROBE 4**

Larger & brighter color screen. Easy resistance testing. 001 OHMS - 100K OHMS accuracy. Load test circuits. Circuit health check. 23' power lead for long reach. 4mm Banana Jack for optional accessories. 50MS testing AC & DC. Min/Max voltage / reading capture. Sale \$281.88 **Tool Club \$225.50**

# POWER PROBE®

**PPKIT03S  
POWERPROBE3 MASTER KIT**

- Includes:**
- PowerProbe 3 Tester
  - ECT3000 Short Circuit Finder
  - PPLS01 Test Lead Set
- Features:**
- Power Up Components
  - Audio Tone Voltmeter
  - 12 - 24 Volt Range
  - 20ft. Jumper Lead Set
  - Bad Ground Indicator
  - Continuity Tester
  - Short Circuit Indicator
  - Relay and Component Tester
- Sale \$374.94  
**Tool Club \$299.95**



**PPKIT04  
POWERPROBE IV  
MASTER COMBO KIT  
SAVE TIME AND MONEY  
WITH AN ALL IN ONE KIT!!**

- Includes:**
- PowerProbe IV Tester
  - ECT3000 Short Circuit Finder
  - PPLS01 Test Lead Set
- Sale \$437.44  
**Tool Club \$349.95**



**PPTM01AS  
POWERPROBE Maestro Kit**

- 2.2" color LCD
  - EZ Learning
  - Guided diagnostic screens
- Includes:**
- PowerProbe Maestro unit w/ 23ft Power Lead
  - 4" Probe Tip
  - Alligator Clip Adapter
  - Battery Clip Set
- Sale \$362.44  
**Tool Club \$289.95**



**PP3LS01  
POWERPROBE3  
Lead Set Kit**

- Includes:**
- PP319FTC, cigarette lighter adapter, 3" probe tip, battery hook-up clips, 20' extension cable, alligator clip adapter, 1', 3' and 6' leads, male & female adapters, piercing probes.
- Sale \$249.94  
**Tool Club \$199.95**



**PPECT3000  
Short / Open Circuit Tracer**

- Identify and locate shorts or open circuits in the wiring.
  - Includes bulb adapters, back probe, blade probe, piercing probe, alligator clip, universal banana plug lead with 4mm plug.
  - Automatic and manual sensitivity locking.
  - Arrow indicates direction to short.
  - Signal Distance indicator bar.
  - 10 minute auto shut off.
  - Ergonomic housing.
- Sale \$212.44  
**Tool Club \$169.95**





**TA18650 Deutsch Terminal Service Kit**  
Includes terminal release tools and crimpers for Deutsch terminals.  
Sale \$174.94 **Tool Club \$139.95**



**LIS69300 Master Relay and Fused Circuit Test Kit**

Includes 8 Jumpers to fit most popular relays, Test Lead Kit & Terminal Leads. Allows testing of relay configurations not covered by our eight Relay Test Jumpers, Like Volkswagen, BMW and other European vehicles.  
\*Relay Puller Pliers easily remove electrical relays.  
Sale \$237.44 **Tool Club \$189.95**



**IPA8016 Fuse Saver Master Kit**  
Resettable breaker handles for use on any circuit. Quick disconnect for on-the-spot repairs. BuzzAlert provides an audible alert when the circuit triggers. Includes 5, 10, 15, 20 and 30 amp breaker handles. Packaged in a blow molded case.  
Sale \$274.94 **Tool Club \$219.95**

**WILW9053 22pc Terminal Release Kit**  
Contains styles and sizes to fit most domestic and imported cars, trucks, motorcycles, computer wiring harnesses and power supply connector plugs.  
Sale \$28.13 **Tool Club \$22.50**



**ES190 Relay Buddy Automotive Relay Tester**  
Tests 4/5 Pin Relays - 3 different relay types. Quick and easy "off the car" relay test. Tester uses 12V battery from vehicle, cycles the relay 10 times.  
Sale \$75.44 **Tool Club \$60.35**



**LIS46950 Relay Puller Pliers**  
For most domestic & import vehicles.  
Sale \$22.44 **Tool Club \$17.95**



**IPA9038A Relay Bypass Switch Master Kit with Amp Loop**  
Controls relay circuit with "On/Off" switch to test the amps.  
Sale \$127.81 **Tool Club \$102.25**



**LIS71750 LED Quick Change Terminal Tool Set**  
Light handle illuminates electrical connectors. Includes 24 quick connect terminal disconnect tools, sheathing ripper and a terminal repair tool.  
Sale \$215.63 **Tool Club \$172.50**



**WILW89732 23pc Terminal Release Kit**  
Contains terminal release tools for most domestic, European and Japanese cars and trucks. Application reference chart.  
Sale \$157.44 **Tool Club \$125.95**



**CTA9812 26pc Terminal Tool Kit**  
For both import & domestic vehicles. Made with high quality steel. Includes application chart with a cross reference for terminal brands.  
Sale \$162.44 **Tool Club \$129.95**

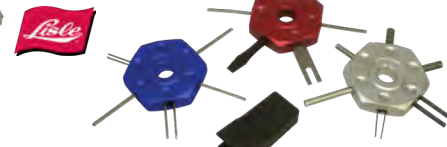

**LIS7750 Wire Terminal Tool Kit**  
Works on conventional, Pack-Con, Weather Pack terminals and many GM vehicles. Blue tool fits many Ford applications.  
Sale \$60.63 **Tool Club \$48.50**



**LIS13120 Electrical Connector Tool**  
For Weather-Pack and other terminals.  
Sale \$11.88 **Tool Club \$9.50**

**ES125 Digital Tach Advance Timing Light**  
Sale \$116.19 **Tool Club \$92.95**



**TA18700 11pc SAE 12-22 AWG Service Deutsch Terminal Crimper Set**  
Use with Deutsch, Weather Pack, Metri Pack and Molex terminals. Color coded aluminum handles. Comes in a blow-molded carrying case with each tool identified in the case.  
Sale \$281.19 **Tool Club \$224.95**



**TA18550 Deutsch Terminal Release Tools**  
Ranges: 14-16, 16-18, 20-24. All metal construction.  
Sale \$51.56 **Tool Club \$41.25**



**CTA2246 7pc Deutsch Terminal Tool Kit**  
Includes 7 of the most popular sizes: 5.6mm, 4.6mm, 4.1mm, 4.0mm, 2.9mm(x2) & 1.8mm. Used for servicing Deutsch terminals. Comes in a hook and loop closure pouch.  
Sale \$78.69 **Tool Club \$62.95**



**MEMORY SAVERS**

**EZRMS4000 Memory Saver**  
Self contained unit. 12 volt, 4.5 aH sealed lead acid battery inside unit. LED indicates connection to battery circuit. Protected by a 4 amp circuit breaker.  
Sale \$112.44 **Tool Club \$89.95**



**LANG295A Memory Saver**  
Uses 9V battery (not included).  
Sale \$16.56 **Tool Club \$13.25**



**SOLESA30 Memory Saver**  
Uses 12V power port such as a booster pack  
Sale \$14.94 **Tool Club \$11.95**





**AST9478**  
**220pc Weather Pack Interchangeable Ratcheting Crimping Tool Kit**  
 For assembling and crimping a wide range of the most common Delphi Weather Pack Connectors. 216 pieces of accessories.  
 Sale \$124.94 **Tool Club \$99.95**

**TIT11950**  
**7pc Ratcheting Terminal Wire Crimping Set**  
 6 interchangeable dies. Quick-change jaw. Built-in safety release.  
 Sale \$145.63 **Tool Club \$116.50**



**TA18900**  
**Ratcheting Terminal Crimper**  
 Crimps 10 - 22 gauge insulated terminals.  
 Sale \$37.44 **Tool Club \$29.95**



**CL958G**  
**6" Wire Stripper**  
 Sale \$17.81 **Tool Club \$14.25**



**CL909G**  
**H.D. 9-3/4" Crimping Pliers**  
 Sale \$29.38 **Tool Club \$23.50**



**CL911G**  
**9-1/2" Cable Cutter**  
 Sale \$36.56 **Tool Club \$29.25**



**CL968**  
**7.5" Forged Wire Stripper**  
 Sale \$50.31 **Tool Club \$40.25**



**TIT11476**  
**Mini Electrical Plier Set**  
 Includes cutter, stripper, and crimper.  
 Sale \$37.44 **Tool Club \$29.95**



**WILW202**  
**2-in-1 Wire Stripper / Crimper**  
 Changes from wire stripper to crimper.  
 Sale \$28.75 **Tool Club \$23.00**



**LIS57850**  
**Battery Carrier**  
 Sale \$19.19 **Tool Club \$15.35**



**LIS68280**  
**Compact Wire Stripper**  
 8 to 14 gauge wires.  
 Sale \$34.94 **Tool Club \$27.95**



**LIS68250**  
**Compact Wire Stripper**  
 14 to 24 gauge wires.  
 Sale \$34.94 **Tool Club \$27.95**



**TA19100**  
**Wire Stripper for Recessed Areas**  
 Strips & cuts 12-22 gauge single or multiple stranded conductor wire.  
 Sale \$27.44 **Tool Club \$21.95**



**TA18950**  
**Automatic Wire Stripper**  
 Strips, crimps & cuts 10 - 26 gauge wire.  
 Sale \$24.69 **Tool Club \$19.75**



**TA19000**  
**Automatic Wire Stripper**  
 Strips, crimps, and cuts 10 - 26 gauge wire.  
 Sale \$27.81 **Tool Club \$22.25**



**TIT11475**  
**Self Adjusting Wire Stripper, Crimper & Cutter**  
 For 10 - 24 gauge wire.  
 Sale \$30.63 **Tool Club \$24.50**



**TIT11478**  
**Wire Stripper**  
 Cuts solid AWG 8 to 20 and stranded wire 8 to 22 gauge.  
 Sale \$19.69 **Tool Club \$15.75**



**WILW200**  
**Automatic Wire Strippers**  
 For 8 - 18 gauge wire.  
 Sale \$17.44 **Tool Club \$13.95**



**TIT11400**  
**9" Pistol Grip Needle Nose Pliers / Crimper**  
 Ergonomic pistol grip for more power and less fatigue. Perfect for hard to reach areas. Built-in wire cutter and crimper.  
 Sale \$13.13 **Tool Club \$10.50**



**EZRPG5**  
**5-in-1 Pistol Grip Pliers**  
 10" long nose pliers with crimping, cutting, wire stripping, and fastener extraction functions. Offset jaws and ergonomic pistol grip.  
 Sale \$40.31 **Tool Club \$32.25**



**LIS11120**  
**Battery Brush**  
 Plastic Case  
 Sale \$9.94 **Tool Club \$7.95**



**KDT201D**  
**Battery Brush**  
 Plastic case  
 Sale \$10.63 **Tool Club \$8.50**



**EZRBMK1914**  
**7pc Battery Maintenance Kit**  
 Two sets of pliers, 3 wrench sizes, puller, cable & post cleaner.  
 Sale \$74.94 **Tool Club \$59.95**



**EZRB795**  
**Heavy Duty Crimping Tool**  
 Exerts equal pressure on all contact points. 50 different crimp settings. No dies to replace or misalign. 6 gauge through approximately 5/8" cable.  
 Sale \$174.06 **Tool Club \$139.25**

**EZRB7946**  
**3 Point Crimper For Battery Terminals**  
 Sale \$82.44  
**Tool Club \$65.95**



**LIS54150**  
**H.D. Terminal Puller**  
 Sale \$31.88  
**Tool Club \$25.50**



**TIT11981**  
**H.D. Cable Crimper**  
 Powerful hydraulic action delivers force of 10 tons. Includes 8 dies. 17.5" Long.  
 Sale \$104.38 **Tool Club \$83.50**



**KDT3367**  
**5/16" Ratcheting Side Terminal Wrench**  
 Sale \$19.94 **Tool Club \$15.95**



**EZRBCK18**  
**H.D. Battery Cable Repair Kit**  
 All the tools needed to repair, build and create battery terminal cables - on or off the vehicle. This set of heavy duty tools can be used with a pneumatic driver or ratchet as well as the included breaker bar. Making precise cuts and crimps has never been easier. Strip the jackets with the precision stripper for a neat and secure connection.  
 Sale \$189.69 **Tool Club \$151.75**





**ES146  
54pc Automotive  
Test Connectors**

Allows connection to most automotive vehicle connectors, foreign and domestic. Connects easily to most DMM's and scopes. Includes 48" stacked banana plug test leads. Sale \$159.38 **Tool Club \$127.50**



**ES147  
18pc Micro 64  
Test Connector Kit**

Variety of terminal adapters which enable connection to Micro64 terminals. Sale \$120.63 **Tool Club \$96.50**



**ES142  
PRO Test Lead Kit**

Includes: Set of Interconnect Leads (64"), Test probes, Flexible Silicon Back Probe Pins, Wire Piercing Clips, HD Insulation Piercing Clips, Crocodile Clips & Deluxe Storage Pouch. Sale \$91.56 **Tool Club \$73.25**



**TEST LEADS**

**CTA7662  
92pc Master Line Kit**  
Comprehensive electrical & electrical testing kit for cars, trucks, tractors, ATVs, Motorcycles, boats & more. 1000V & 30 Amps plus CE certified. Safety covers for sharp probe tips. Sale \$305.63 **Tool Club \$244.50**



**TA23500  
20pc Back Probe Kit**  
Use to back probe harness connectors, fuel injectors and automotive sensors. Straight, 45 degree & 90 degree stainless steel probes in .027" and .040" diameters. Color coded for easy identification. Compatible with standard 4mm plug. Sale \$30.31 **Tool Club \$24.25**

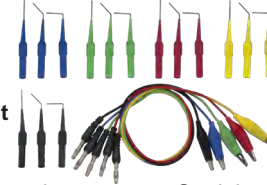

**ES195  
Super Relay  
Buddy Pro Kit**  
Next generation tester for 12V automotive relays. Applies a 7+ amp load to the relay. Tests 10 different relays. Sale \$212.44 **Tool Club \$169.95**



**RETRACTABLE  
TEST LEADS**



Part #	Leads	Sale	Club
LANG1129	3 x 10'	\$23.13	<b>\$18.50</b>
LANG1135	3 x 10' Magnetic	\$31.88	<b>\$25.50</b>
LANG1137	2 x 30'	\$43.69	<b>\$34.95</b>
LANG1138	2 x 30' Magnetic	\$44.94	<b>\$35.95</b>
LANG1176	2 x 15' w/ Adapters	\$68.69	<b>\$54.95</b>

**ES804  
EZ Test™ 10pc  
Back Probe Kit**  
Designed for backprobing, diagnostic testing & electrical troubleshooting. Sale \$46.56 **Tool Club \$37.25**

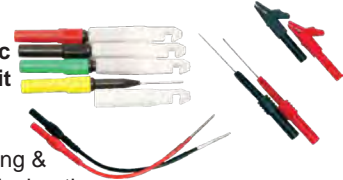

**LIS64900  
17pc Back Probe & Alligator Clip Set**  
Good for all test leads. Sale \$59.94 **Tool Club \$47.95**



**TEST LIGHTS**

**LIS32150  
Power & Ground Outlet**  
Provides a convenient ground and power source. Sale \$21.88 **Tool Club \$17.50**



**LIS32900  
HD Circuit Tester & Jumper**  
Test circuits up to 12 volts and works as a jumper wire for power or ground. Sale \$31.19 **Tool Club \$24.95**



**LIS28640  
Ultimate  
Circuit  
Tester Kit**  
Tests low voltage up to 28 volts. Finds electrical shorts, checks polarity, detects battery drain, and checks circuits from a distance. 8' heavy duty coil cord. Sale \$49.38 **Tool Club \$39.50**



**LIS28830  
Digital Circuit Tester 3-49v**  
Digital LCD display accurately shows DC voltage. Red and green lights for positive and negative polarity. 12' coil cord. Sale \$87.44 **Tool Club \$69.95**



**TA27250  
X-Long  
Circuit Tester**  
For 6 & 12 volt testing. 12' retractable cable. 6-1/2" long probe. Sale \$21.88 **Tool Club \$17.50**



**TA28100  
Automotive  
Logic Probe**  
Computer safe. For systems up to 24V. LED glows red for power (+) and green for ground (-). 6' long wire. Sale \$20.63 **Tool Club \$16.50**

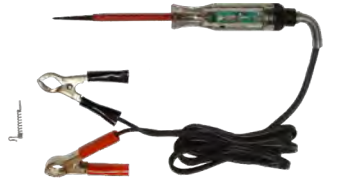

**TA27000  
H. D. Circuit Tester**  
For 6 & 12 volt systems. 5' tough, flexible, & insulated rubber wire. Sale \$9.94 **Tool Club \$7.95**



**LIS29050  
Digital Circuit Tester 3-30v**  
360° visibility of polarity. 47" cord with heavy duty alligator clip. Insulated probe. Sale \$57.81 **Tool Club \$46.25**



**TA27300  
Circuit Tester**  
For 6 & 12 volt systems. 12' retractable wire. 3-1/4" probe. Sale \$16.88 **Tool Club \$13.50**



**TA28000  
H.D. Automotive  
Logic Probe**  
For 6, 12, & 24 volt systems. 6' dual leads with large battery clip. Sale \$20.63 **Tool Club \$16.50**



**CTA3032  
12/42V Hybrid  
Car Circuit Test**  
Automatic volt identification. 10' cable with hooded alligator clip. Sale \$34.38 **Tool Club \$27.50**



**TITAN  
TIT11436  
Digital Circuit Tester 6-48v**  
Blacklit LED provides a "no guess" voltage value of the circuit. Surge protected circuitry. Sale \$28.44 **Tool Club \$22.75**



# MULTIMETERS



### FLK88-5AKIT Multimeter Kit

Includes: 88V Multimeter, test leads, alligator clips, test probes, inductive RPM pickup, temp. probe, backprobe pins, insulation piercing probe, holster & 9V battery. Built-in thermometer. Magnetic hanger for easy set up. Large, backlit display. Sale \$749.94 **Tool Club \$599.<sup>95</sup>**



### ES585K Multimeter & Engine Analyzer

Features: Volt, Inductive Amps, Ohms, Temp, Tach, Hz, Dwell, Duty Cycle, Continuity, Diode Test & AC/DC. Sale \$131.19 **Tool Club \$104.<sup>95</sup>**



### ES480A Multimeter

Features: Volt, Amps, Ohms, Tach, Hz, Dwell, Duty Cycle, Capacitance, Continuity, Autoranging & AC/DC. Sale \$62.19 **Tool Club \$49.<sup>75</sup>**



### ES385A Multimeter

Includes: DC Volt, DC Amps, Ohms, Tach, Hz, Dwell, Duty Cycle, Diode & Continuity. Sale \$82.44 **Tool Club \$65.<sup>95</sup>**

### ES688 True RMS Low Current Clamp Meter

Larger clamp size (19mm). True RMS accuracy. Great for parasitic drain testing. Accurate to 1 mA. Sale \$299.94 **Tool Club \$239.<sup>95</sup>**



### ES655 High Current Probe/DMM

For all high current apps, especially starting and charging diagnostics. Up to 1000 Amps AC or DC. 37 Test Ranges & 10 Test Functions. Sale \$196.56 **Tool Club \$157.<sup>25</sup>**



### ES333 Dual Mode Tachometer

Laser mode: Detects up to 6 ft. away. Contact mode: with interchangeable tips. Sale \$124.94 **Tool Club \$99.<sup>95</sup>**



### FLK115 Field Technicians Digital Multimeter

Compact True-rms digital multimeter for field service. Includes: meter, holster, 4 mm silicone test lead set. Easy one-handed operation of the meter. Min/Max/Average to record signal fluctuations. Sale \$299.94 **Tool Club \$239.<sup>95</sup>**



### FLK117 Electrician's Multimeter w/ Non-Contact Voltage

Compact, true-rms digital multimeter for electricians. Includes multimeter, 4mm silicone test leads, holster and manual. Integrated non-contact voltage detection. Selectable low-impedance mode. Sale \$324.94 **Tool Club \$259.<sup>95</sup>**



### FLK88-5 Deluxe Automotive Multimeter

Pulse width, duty cycle, Min/Max/Avg recording. 10 meg ohm input impedance won't damage computer circuits. Large display and bright backlight for increased visibility. Can measure voltage up to 1000 V AC and DC, current up to 10 A, 20 A for up to 30 seconds and frequency to 200 kHz and % duty cycle. Sale \$562.44 **Tool Club \$449.<sup>95</sup>**



### CRI-N2BASE01 N2 Neuron - 2 Channel Graphing Bluetooth Measurement System

- Industry's first compact Bluetooth graphing measurement system
  - Full Multimeter with every electrical test you need: -Volts AC/DC (TRMS) -Ohms -Amps AC/DC -Temperature
  - Specialty Functionality For Advanced Testing: -Graphing Wave Forms and readings (also data logging) -Parasitic Draw Testing -Multi-Zone Temperature Testing -2nd on board Voltmeter - for use with clamps/transducers/voltage drop.
  - iOS & Android applications let you use your phone, tablet or scan tool to connect to the N2 wirelessly & get your testing done quickly & accurately.
  - Built-in system for testing: Battery Systems, Charging Systems, Ignition Systems, Sensors, Temperature Systems, Voltage Drop Tests, Parasitic Draw Testing, Power Testing & More!
- Sale \$324.94 **Tool Club \$259.<sup>95</sup>**

curien **NEW!**



# OSCILLOSCOPES



### ATLMP408 MaxiScope 4 Channel Oscilloscope

Works with PC or MaxiSys tablet to gain insight on electronic circuits. Measure and test virtually all the electronic components and circuits in any modern vehicle. Records and plays back waveform data. Free online software updates. Sale \$474.94 **Tool Club \$379.<sup>95</sup>**



### LANG13805 Automotive Scope / Graphing DMM

- Sample Rate: 20 mega-samples / second.
  - 48 pre-set waveforms that include: sensor, actuator, electrical, and ignition patterns.
  - DC to 5 MHz bandwidth.
  - "Glitch Snare" made captures display
  - Dimensions: 12.5" x 15.5" x 4.5"
  - Sweep Rate: 1 μs to 50 seconds in Scope Mode
- Sale \$1,312.44 **Tool Club \$1,049.<sup>95</sup>**



MULTIMETERS / INSULATED TOOLS

**MIDTRONICS**

**MIDPBT300 Professional Battery Tester**

Measurement range from 100 - 1400 CCA. Green & Red LEDs give fast decisions on starter and charging system testing. Bad cell detection & high/low voltage capture for improved testing. Sale \$362.44 **Tool Club \$289.95**



**MIDMDXP300 Battery & Electrical System Analyzer**

Tests 12 volt batteries & systems for cars and light trucks and displays results. Tests lead-acid, AGM, and GEL batteries. Integrated printer with a customizable header on printout. Sale \$749.94 **Tool Club \$599.95**



**MIDCPX900 12V Battery & Electrical System Analyzer**

3.5" color display. On-Tool Wi-Fi & Bluetooth capabilities. Supports conventional lead-acid, AGM, Gel and EFB (enchanced flooded batteries). Sale \$1,374.94 **Tool Club \$1,099.95**



**MIDMDX650PSOH Battery & Electrical System Analyzer**

Tests lead-acid, AGM, EFB, and Gel batteries 100-2000 CCA. Detects bad-cells. New (State-of-Health) graph helps interpret test results. Intermediate starter and alternator test. Built-in printer. 10' field/replaceable cables, larger clamps open wider, new protective rubber boot. Sale \$1,124.94 **Tool Club \$899.95**



**ASO12-1015 Battery & Electrical System Analyzer With Printer**

Lightweight hand-held digital battery tester with Thermo Printer and USB port. Stores last test series with or without power. For testing all 12V automotive starting batteries rated in CCA, SAE, DIN, JIS#, IEC, EN and CA. Also for testing vehicle's Electrical System. Carrying case and cables included Sale \$499.94 **Tool Club \$399.95**



**ATLBT608 MaxiBAS Battery & Electrical System Diagnostics Tool**

Support in-vehicle and out-of-vehicle testing. Test 6 & 12 V batteries. Test 12 & 24 V cranking/charging systems. Test Flooded, AGM, AGM Spiral, EFB & GEL batteries. Sale \$624.94 **Tool Club \$499.95**



**TOP-BT300P 12/24V Battery & Electrical System Tester**

Tests 12V batteries. Tests 12V/24V vehicle electronic systems. Tests lead-acid batteries, flooded, AGM, Gel & EFB. Includes built-in printer to print test results within seconds! Spark-free copper clamps, PVC-coated wiring, and built-in automatic protection against reverse polarity Sale \$123.75 **Tool Club \$99.00**



**TOP-T4000 Tornado4000 4-Amp Fully Automatic Battery Charger**

Charges 6V & 12V lead-acid batteries & 12V lithium-ion batteries. Compatible with regular flooded, AGM, GEL, & deep-cycle batteries. Provides spark-free operations and reverse polarity protection. Revolutionary 9-step charging allows for faster charging and better battery maintenance. Sale \$57.49 **Tool Club \$45.99**



**TOP-H200 Hurricano200 Portable Lithium Power Station**

49,800mAh Battery Capacity. Provides 200W total power output and works on any device that consumes under 200W. Power up to 7 devices at once! Sale \$186.25 **Tool Club \$149.00**



**FLASHING POWER SUPPLY**



**ASOESS6100 Reflash Power Supply & Heavy Duty Battery Charger - 12V/120A** Charged 12V lead acid and lithium (LFP) batteries from 5 to 1500 Ah. 8-step charging for lead and 9-step charging for LFP lithium. Supports up to 100A for 12V batteries in vehicles in the diagnostic phase and in maintenance workshops. Allows you to check a vehicle's battery voltage, evaluate the starting system, and the condition of the alternator. Recovers deeply discharged batteries greater than 2V (automatic SOS recovery). **120V Power Supply.** Sale \$1,624.94 **Tool Club \$1,299.95**

**BATTERY TESTERS, 6/12 VOLT BATTERIES, ALTERNATORS & STARTERS.**

- One hand operation.
- Easy to read meter.
- Recessed meter/insulated clamps.

**ASO6029 6/12V Battery Load Tester**  
125 Amp Load.  
0-16V DC.  
Sale \$162.44  
**Tool Club \$129.95**



**ASO6031 6/12V "Pro" Battery Load Tester**  
Includes cable for GM diode trios.  
125 Amp Load.  
0-16V.  
Sale \$206.88  
**Tool Club \$165.50**



**OTC3182 130 Amp Digital Battery Load Tester**  
Tests 6 & 12V batteries.  
0-16 volt range.  
Sale \$118.13  
**Tool Club \$94.50**



**SOLBA9 40-1200 CCA 12V Digital Battery & System Tester**  
4.5-16V operating range.  
40-1200 CCA testing capacity.  
Tests multiple battery types.  
Tests to CCA, CA, DIN, EN, IEC standards.  
Small, portable and pocket-sized.  
Sale \$71.88 **Tool Club \$57.50**



**ES710 500 Amp Battery Load Tester**  
Tests batteries, alternators, starters and regulators.  
Sale \$157.44  
**Tool Club \$125.95**



**ES706 Digital Load Tester**  
Automatic tester.  
No guessing how long to apply the load.  
Sale \$74.94  
**Tool Club \$59.95**



**ES700 100 Amp Battery Tester**  
Internal load capacity: 100 amps.  
Tests battery voltage, relative starter current with heat protection draw, charging voltage, and battery condition. H.D. cable clamps.  
Sale \$49.94 **Tool Club \$39.95**





# TOPDON

## TOP-TORNADO9000 TORNADO9000 12/24V Smart Battery Charger

Output current:  
12V 5-90A; 24V 5-45A.  
6 charging modes, with adjustable current & voltage. ECU Programming voltage stabilizer. Can act as a stable power supply for various automotive appliances such as tire inflators, car fridges & more! 9-Step Smart Charging eliminates overcharging. Multi-Protection System. For batteries 20-2800Ah. Sale \$812.44 **Tool Club \$649.95**



**NEW!**  
12/24V

# BATTERY CHARGERS

6/12V

**ASO6001A**  
6/12 Volt H.D.  
Battery Charger  
Highest performance fast charger on the market. 75 Amp continuous charge with 375 Amp crank assist. Rugged 7" tires. 625 Amp boost. Sale \$1,062.44 **Tool Club \$849.95**



6/12V  
18/24V

**ASO6006AGM**  
6/12/24 Volt H.D.  
Commercial Fleet Charger  
This heavy-duty fleet chargers 6/12/24V batteries with five charging positions. UL continuous rating: 70/65/30 Amp; UL cranking assist rating: 280 Amp. AGM Charging Supported! Sale \$849.94 **Tool Club \$679.95**



6/12V  
18/24V

**ASO6002B**  
6/12/18/24 Volt  
H.D. Commercial  
Battery Charger  
Highest performance fleet charger on the market. Rated up to 80 Amp continuous charge with 400 Amp crank assist at 12v. 725 Amp boost rating. Sale \$1,212.44 **Tool Club \$969.95**



12V

**ASOIBC6008MSK**  
12V Digital Intellamatic  
Battery Charger  
Micro-processor controlled and fully automatic. Electrical Stability System (ESS™) technology. Nominal 13.7V DC Output Memory Saver Mode. 15A Continuous/20A Peak Patented diagnostics indicate weak or defective batteries. Charges all types of 12V batteries. Designed for AGM, Gel Cell, Sealed, and Standard Flooded batteries including Spiral Cell, Orbital™, or Optima™ batteries. Dead Battery Override control. "Safe In Any Weather" Operation. Reverse polarity protected. 5 Amp 12' Straight Cable with OBDII Connector Sale \$1,368.75 **Tool Club \$1,095.00**



**ASO6010B**  
H.D. Commercial  
Portable Battery Charger 6/12/24V  
Charges all standard and maintenance free 6/12/24 volt batteries with 4 charging positions. 120 minute automatic timer. Stop/go-light technology. 500 Amp clamps. Sale \$749.94 **Tool Club \$599.95**



# PRO-LOGIX

**SOLPL2410**  
2/6/10 Amp  
Battery Charger  
Advanced multi-phase charging process. For 12 & 24 volt batteries. Sale \$178.69 **Tool Club \$142.95**



**SOLPL2320**  
20/10/2 Amp  
Battery Charger  
Advanced multi-phase charging process. For 6 & 12 volt batteries. Sale \$142.44 **Tool Club \$113.95**



**SOLPL2310**  
10/6/2 Amp  
Battery Charger  
Advanced multi-phase charging process. For 6 & 12 volt batteries. Sale \$112.44 **Tool Club \$89.95**



**NOCGEN1**  
1-Bank 10 Amp  
On-Board Battery  
Charger  
Charges starter and deep-cycle batteries up to 230Ah. Sale \$137.44 **Tool Club \$109.95**



**ASO9002A**  
1.5 Amp Auto Charger  
Can be mounted in vehicle. Shuts down automatically Sale \$64.06 **Tool Club \$51.25**



# MULTIPLE BATTERY CHARGERS

## SOLAR PRO-LOGIX

**SOLPL4020**  
4 Bank Charger  
4 independent charging channels. 2 amp output per channel. For flooded & AGM batteries. Sale \$212.44 **Tool Club \$169.95**



# ASSOCIATED

MADE IN USA  
BATTERY CHARGERS  
"SAFE IN ANY WEATHER" OPERATION

6/12V

**ASOUS20**  
6/12 Volt  
40 Amp Charger  
200 Amp Cranking Assist. 330 Amps Manufacturer's Boost Rating. 90 minute timer with HOLD. For small shop owner and DIY. Sale \$424.94 **Tool Club \$339.95**



6/12V

**ASO6009AGM**  
6/12 Volt H.D. Fast Charger  
Continuous ratings: 70/60/2 Amp; Boost rating: 540AUL Cranking assist rating: 265A A.C. cord: 6-1/2"/16-3. DC leads: 7' / 4AWG Clamp Rating: 500A. Weight 48 lbs. Transformer/rectifier limited warranty-5 Years New 2 Year Bumper to Bumper Warranty. AGM Charging Supported! Sale \$787.44 **Tool Club \$629.95**



## SOLAR PRO-LOGIX

**SOLPL3760**  
60/40/10/250A 12/24V  
Intelligent Wheeled  
Charger w/ Engine Start  
12/24 Volt charging and maintaining. 60<->40/40/10A 12V charging rates. 20/10A 24V charging rates Fully automatic, multi-phase charging process. Charges multiple lead acid battery types. Forced start allows charging of totally dead batteries Sale \$562.44 **Tool Club \$449.95**



BATTERY CHARGERS

# NOCO® HEAVY DUTY MINI BOOSTER PACS

JUMP STARTERS / INVERTERS



**NOCGB20**  
400 Amp UltraSafe Lithium Jump Starter  
Spark-proof connections and reverse polarity protection. Recharges USB devices. LED flashlight. Jump starts gas engines up to 4 liters. Provides up to 20 jump starts on a single charge.  
Sale \$112.44 **Tool Club \$89.95**



**NOCGB150**  
3,000 Amp UltraSafe Lithium Jump Starter  
Spark-proof connections and reverse polarity protection. Recharges USB devices. LED flashlight. Jump starts both gas & diesel engines up to 10 liters and more. Provides up to 80 jump starts on a single charge.  
Sale \$412.44 **Tool Club \$329.95**



**NOCGB500**  
20,000 Amp 12/24V Lithium Jump Starter  
12V and 24V lithium jump starter rated at 20,000 Amps, 80,000 Joules3S (10,000 Amps, 40,000 Joules3S in 24V). Patented safety protection with spark-proof technology and reverse polarity protection that allows it to connect to any battery safely. 12-volt power from anywhere. Designed for both gas and diesel engines up to Class 8+/CE high-displacement vehicles, equipment, trucks.  
Sale \$2,187.44 **Tool Club \$1,749.95**



**NOCGB40**  
1,000 Amp UltraSafe Lithium Jump Starter  
Spark-proof connections and reverse polarity protection. Recharges USB devices. LED flashlight. Jump starts gas engines up to 6 liters, and diesel up to 3 liters. Provides up to 20 jump starts on a single charge.  
Sale \$137.44 **Tool Club \$109.95**



**NOCGB70**  
2,000 Amp UltraSafe Lithium Jump Starter  
Spark-proof connections & reverse polarity protection. Recharges USB devices. LED flashlight. Jump starts gas engines up to 8 liters, & diesel engines up to 6 liters. Provides up to 40 jump starts on a single charge.  
Sale \$274.94 **Tool Club \$219.95**



**NOCGBC014**  
Boost HD EVA Protection Case for GB70  
Carrying handle. Rugged zipper. Rugged storage  
Sale \$37.44 **Tool Club \$29.95**  
**NOCGBC015**  
Boost HD EVA Protection Case for GB150  
Carrying handle. Rugged zipper. Rugged storage  
Sale \$43.69 **Tool Club \$34.95**

**CAL590**  
BOOST ULTRA  
Portable Jump Starter & Battery Pack  
800 cold cranking amps.  
4,000 peak amps.  
30,000mAh battery.  
Professional grade power can jump start large diesels and high-compression gasoline engines!  
Sale \$309.38 **Tool Club \$247.50**



**CAL550**  
BOOST Portable Jump Starter & Battery Pack  
300 cold cranking amps.  
12000mAh battery.  
New design. Includes car, house chargers and booster cables.  
Sale \$109.38 **Tool Club \$87.50**



**CAL560**  
BOOST MAX  
Portable Jump Starter & Battery  
450 cold cranking amps.  
900 peak amps. Updated unit with rugged outer housing and professional grade H.D. clamps.  
Sale \$160.63 **Tool Club \$128.50**



**NEW!**



**TOP-JS1200**  
Jumpsurge1200 1200W Portable Battery Jumpstarter  
10,000 mAh capacity. 1,200 peak amps. 25 jump starts on a full charge. Boost function revives dead or damaged batteries! Innovative Stop Spark™ sensors. 300 Lumens flashlight. Usb quick charge 3.0 Port. Sturdy outer housing is resistant to water, dust, and wear.  
Sale \$112.49 **Tool Club \$89.99**

**NEW!**



**TOP-JS2000**  
Jumpsurge2000 2000A Portable Battery Jumpstarter  
16,000 mAh capacity. 2,000 peak amps. 35 jump starts on a full charge. Boost function revives dead or damaged batteries! Innovative Stop Spark™ sensors. 300 Lumens flashlight. Usb quick charge 3.0 Port. Sturdy outer housing is resistant to water, dust, and wear.  
Sale \$137.49 **Tool Club \$109.99**

**NEW!**

**TOPDON**



**TOP-JS3000**  
Jumpsurge3000 3000A Portable Battery Jumpstarter  
24,000 mAh capacity. 3,000 peak amps. 45 jump starts on a full charge. Boost function revives dead or damaged batteries! Revive up to 9L gas vehicles & 7L diesel vehicles. Innovative Stop Spark™ sensors. 400 Lumens flashlight. Usb quick charge 3.0 Port. Sturdy outer housing is resistant to water, dust, and wear.  
Sale \$249.99 **Tool Club \$199.99**



**KKJNC660**  
12v Portable Jump Starter  
Peak Amps: 1700.  
Cranking Amps: 425.  
Built-in charger - charges with any extension cord. Voltmeter for charge status of onboard battery. 12v DC outlet.  
Sale \$206.19 **Tool Club \$164.95**



**KKJNCAIR**  
12v Portable Jump Starter with Air Compressor  
Peak Amps: 1700  
Cranking Amps: 425  
68" cables. Includes 12' coiled air hose with screw on chuck. Automatic charging.  
Sale \$343.69 **Tool Club \$274.95**



**KKJNC1224**  
12 & 24 Volt Jump Starter  
46" cables. Built-in automatic charger. 12v DC outlet. Voltmeter for on-board battery status.  
12v: Peak Amps (3400) Cranking Amps (850)  
24v: Peak Amps (1700) Cranking Amps (425)  
Sale \$574.94 **Tool Club \$459.95**



**KKJNC770R**  
Premium 12v Portable Jump Starter  
Extra long 68" cables. PowerJaw clamps for maximum power transfer and durability. Peak Amps: 1700. Cranking Amps: 425. Dual USB outlets & high intensity LED task light. 12v DC outlet for accessories.  
Sale \$242.44 **Tool Club \$193.95**



**SOLES5000**  
12v Booster Pac  
Peak Amps: 1500. Cranking Amps: 400. Automatic recharging. LED battery status indicator. 43" cables. DC outlet to power 12v accessories.  
Sale \$199.94 **Tool Club \$159.95**



**SOLES1224**  
12 & 24 Volt Booster Pac  
Switches voltages with the switch of a knob. 60" cables. Automatic recharging.  
12v: Peak Amps (3000) Cranking Amps (750)  
24v: Peak Amps (1500) Cranking Amps (370)  
Sale \$587.44 **Tool Club \$469.95**



**KKJNC950**  
12v HD Portable Jump Starter  
Peak Amps: 2000. Cranking Amps: 925. 46" cables. Built-on automatic charger. Voltmeter provides charge status of on-board battery. 12v DC outlet.  
Sale \$437.44 **Tool Club \$349.95**



**SOLES6000**  
H.D. Booster Pac  
Peak Amps: 3,000. Cranking Amps: 800  
54" cables. 12v DC outlet. Automatic charging.  
Sale \$437.44 **Tool Club \$349.95**



**HEAVY DUTY BOOSTER PAC**



**SOLHT1224AGM**  
12/24V Commercial Charger/Starter  
- 10' jumper cables.  
- 12v - 1400 CCA.  
- 24v - 800 CCA.  
- Automatic 7 amp x 2 channel battery charging system.  
- Includes (2) Group 31 AGM batteries.  
- Weight: 189 lbs.  
- Perfect for dealerships and used car lots!  
Sale \$2,499.94 **Tool Club \$1,999.95**

**BOOSTER CABLES**

1 & 2 Gauge cables come with a carrying case.



Part #	Wire Gauge	Amp Rating	Clamp Length	Club
FJC45233	4	600	16ft.	\$48.50
FJC45244	2	600	20ft.	\$68.95
FJC45255	1	800	25ft. HD	\$121.95
REPLACEMENT CLAMPS				
ASO6202		500		\$42.95
ASO6205		800		\$49.75
FJC45262		600		\$10.95

**POWER INVERTERS**

**SOLPI1000X**  
1000W Dual Outlet Power Inverter  
1000W continuous power. 2000W peak power. (2) 110VAC Outlets. Overload/overheat protection.  
Sale \$199.94 **Tool Club \$159.95**



**SOLPI2000X**  
2000W Triple Outlet Power Inverter  
2000W continuous power. 4000W peak power. (3) 110VAC Outlets. Power display showing input voltage and output wattage for easy power demand management.  
Sale \$399.94 **Tool Club \$319.95**



**SOLPI1500X**  
1500W Triple Outlet Power Inverter  
1500W continuous power. 3000W peak power. (3) 110VAC Outlets. Power display showing input voltage and output wattage for easy power demand management.  
Sale \$362.44 **Tool Club \$289.95**



**SOLPI3000X**  
3000W Triple Outlet Power Inverter w/ Junction Box  
3000w continuous power. 6000W peak power. (3) 110VAC Outlets; (1) junction block connection. Power display showing input voltage and output wattage for easy power demand management.  
Sale \$624.94 **Tool Club \$499.95**



## LEAK DETECTION



### UV414565A Spotgun / UV Phazer Black Rechargeable Leak Detection Kit

Includes Rechargeable UV Phazer Black, Spotgun injection system, A/C ExtenDye cartridge (8oz), service stickers, UV glasses & case.  
Sale \$224.94 **Tool Club \$179.95**



### UV332005A Spotgun Jr / UV Phazer Black Leak Detection Kit

Includes: UV Phazer Black (UV413075), Spotgun Jr injection system, (4) 1oz. UV dye cartridges, service stickers, and UV glasses.  
Sale \$124.94 **Tool Club \$99.95**



## DYE

Part #	Size	Fits	Sale	Club
UV488016E	16 oz. - Ester	Universal	\$21.19	<b>\$16.95</b>
UV499108A	8 oz.	Spotgun	\$58.77	<b>\$47.01</b>
UV399020A	(4) 1 oz.	Spotgun Jr	\$55.63	<b>\$44.50</b>
UV499005	4 oz.	Universal	\$44.42	<b>\$35.53</b>

### MSC55900 Intellasense II Refrigerant Leak Detector

Detects all Refrigerants as low as 1/10 oz. per year  
Eliminates many false responses  
Heated Tin Oxide Element  
High, Medium and Low sensitivity  
2000 Hour Sensor Life  
Sale \$249.94 **Tool Club \$199.95**



### MSC56200 "Raptor" Refrigerant Leak Detector w/ UV Light

Detects leaks as small as 1/10 oz per year.  
16" flexible probe.  
3 levels of sensitivity.  
Detects all refrigerants (CFC's, HCFC's, HFC's)  
6 Levels of Sensitivity (15 Levels of Detection)  
Ultra Bright UV/Blue LED Light  
Sale \$249.94 **Tool Club \$199.95**



### MSC91046A A/C System Flush Kit

Works with any light weight A/C flushing agent mixed with pressurized air.  
Sale \$59.99 **Tool Club \$47.99**



## UV LIGHTS

### UV413065 UV Phazer BLACK Rechargeable UV LED Light

True UV LED. Adjustable lens focus. Compact, aluminum housing. Rechargeable lithium-ion battery lasts up to 2 hours. Includes UV glasses.  
Sale \$98.13 **Tool Club \$78.50**



### UV413075 UV Phazer Black

Uses AAA batteries.  
Sale \$78.13 **Tool Club \$62.50**



### UV413020 Pico-Lite

Compact leak detection light. 1 watt Luxeon LED. Includes 3 AA batteries and UV glasses.  
Sale \$68.69 **Tool Club \$54.95**



### SLT66148 Stylus Pro USB UV Rechargeable Pen Light

90 lumens. Comes with 120V AC Adapter, USB Cord, & Nylon Holster. Lasts up to 6.5 Hours  
Sale \$77.19 **Tool Club \$61.75**



### FJC4968 Rechargeable Work Light with UV Leak Detection Light

Three lighting modes. High efficiency COB LED.  
Sale \$62.44 **Tool Club \$49.95**



### WILW2648 FirePoint X UV Flashlight

365-395nm UV light. DuoFocus beam. Water & impact resistant. 2 hour runtime, 15m beam distance. Batteries Includes (2AA).  
Sale \$29.94 **Tool Club \$23.95**



## OIL

Part #	Description	Sale	Club
FJC2432	Estercool Oil - Quart	\$22.81	<b>\$18.25</b>
FJC2439	Estercool Oil - Gallon	\$74.94	<b>\$59.95</b>
FJC2445	Estercool Oil w/ Dye - Quart	\$22.81	<b>\$18.25</b>
FJC2480	Universal PAG Oil w/ Dye	\$29.94	<b>\$23.95</b>
FJC4946	Fluorescent Dye Cleaner	\$22.19	<b>\$17.75</b>

### MSC85530 3-in-1 Side Mount Can Tap Valve

For R134a, R12, & oil charge cans.  
Sale \$15.63 **Tool Club \$12.50**



### FJC6842 3 Way Can Tap

For R12, R134a, & R1234yf.  
Sale \$28.13 **Tool Club \$22.50**



## INJECTORS

### UV330500YF Spotgun Jr™ Injection Kit

Serves 6 vehicles. Includes Six (6) A/C ExtenDye cartridges, R-1234yf adapter, and service stickers.  
Sale \$141.19 **Tool Club \$112.95**



### UV471500A Spotgun Injection Kit

Serves up to 64 vehicles. Includes low-side hose, R12 and R134a adapters.  
Sale \$154.38 **Tool Club \$123.50**



### FJC2732 Hand Turn Oil & Dye Injector

2oz. refillable R12/R134a cylinder for adding oil, dye & STOP Leak.  
Sale \$105.63 **Tool Club \$84.50**



### UV481500YF PAG 46 Oil Spotgun™ HFO Oil Injection Kit

Includes R-1234yf adaptor and PAG 46 HFO oil cartridge.  
Sale \$99.94 **Tool Club \$79.95**



### FJC2734 R134a Oil Injector

Use injector to add 2 oz. of oil to an R134a air conditioning system.  
Sale \$49.94 **Tool Club \$39.95**



### MSC82375 R-134a Oil Injector

With low side quick coupler.  
Sale \$48.13 **Tool Club \$38.50**



### MSC81290 Universal Valve Core Remover / Installer

For R12 & R134a.  
Sale \$8.69 **Tool Club \$6.95**



### MSC91000A Clutch Puller

Serves most vehicles, domestic & imports. Includes a compressor identification chart & blow molded case.  
Sale \$112.44 **Tool Club \$89.95**



## A/C COUPLERS

### MSC98370 R12-to-R134a A/C Manifold Conversion Kit

Sale \$64.38 **Tool Club \$51.50**



### MSC82834 High Side MSC82934 Low Side

Sale \$37.44 **Tool Club \$29.95**



### MSC82214 High Side Swivel MSC82224 Low Side Swivel

Sale \$49.06 **Tool Club \$39.25**



### FJC6011 R134a Manual Coupler Set

Sale \$56.19 **Tool Club \$44.95**



**RA15600**  
**6 CFM Vacuum Pump**  
 2 Stage pump.  
 Best in class.  
 Sale \$649.94  
**Tool Club \$519.95**



**MSC90062-B**  
**3 CFM Vacuum Pump**  
 Ultimate Vacuum:  
 80 microns.  
 1/4 HP motor.  
 Sale \$174.94  
**Tool Club \$139.95**



**MSC90066**  
**6 CFM Vacuum Pump**  
 Ultimate Vacuum:  
 80 microns.  
 1/3 HP motor.  
 Sale \$224.94  
**Tool Club \$179.95**



**FJC6930**  
**R-1234yf / R134a**  
**5 CFM Vacuum Pump**  
 1/3 HP motor.  
 12oz Oil Capacity.  
 Spark-proof series.  
 Voltage: 115V, 60Hz  
 Supplies with 2 ports:  
 R134a and R1234yf.  
 Sale \$349.94  
**Tool Club \$279.95**



**MSC98230**  
**Charging Solenoid Module**  
 The 98230 Charging Solenoid Module turns the 98210-A ACCU-CHARGE II & 98211-A ACCU-CHARGE III into Automatic Programmable Scales!  
 Sale \$212.44 **Tool Club \$169.95**



**MSC89172**  
**R-134a Manifold Set**  
 3" Gauges are vibration dampened.  
 Includes 72" hoses. Extra access port for vacuum line & sight glass.  
 Sale \$212.44 **Tool Club \$169.95**



**MSC89661-PRO**  
**Automotive R-134a Manifold Gauge Set**  
 Complete with 60" hoses and aluminum manual couplers. Large knobs and extra large sight glass.  
 Sale \$162.44 **Tool Club \$129.95**



**FJC6072**  
**8pc R-134a Manifold/Hose Adapter Assortment**  
 Sale \$57.44  
**Tool Club \$45.95**



**FJC6820**  
**R1234YF Conversion Kit**  
 6pc kit with manual couplers.  
 Sale \$124.94 **Tool Club \$99.95**



**MSC83834**  
**Red High Side R1234yf Coupler**  
 Sale \$51.88 **Tool Club \$41.50**



**MSC83934**  
**Blue Low Side R1234yf Coupler**  
 Sale \$51.88 **Tool Club \$41.50**



**RA13203**  
**1 Quart Vacuum Pump Oil**  
 Sale \$12.49  
**Tool Club \$9.99**



**RA13204**  
**1 Gallon Vacuum Pump Oil**  
 Sale \$37.44  
**Tool Club \$29.95**

**A/C GAUGES**

**RA45111**  
**R134a Manifold Hose Kit**  
 Brass manifold. R12/R134a gauges, PSI & °F Temp. 1/2" ACME bottom ports. 90° manual couplers. 72" hoses.  
 Sale \$224.94 **Tool Club \$179.95**

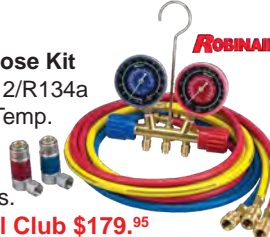

**FJC6785**  
**R134a Manifold Set**  
 Aluminum manifold. 72" Hoses. R134a manual service couplers. Valve core tool, R134a can tap, pocket thermometer  
 Sale \$174.94 **Tool Club \$139.95**



**FJC6850**  
**R1234YF Manifold Gauge Set**  
 Includes: Aluminum manifold with pressure gauges, high and low side service port couplers and 72" hoses packed in a protective plastic case.  
 Sale \$206.19 **Tool Club \$164.95**



**FJC4415**  
**637pc Deluxe Service Item Assortment**  
 High-temperature HNBR construction on all o-rings. O-ring wall chart included. Resistant to aggressive chemicals and abrasion.  
 Sale \$412.44 **Tool Club \$329.95**



**FJC6045**  
**R-134a U-Charge Hose for Self-sealing Valve Cans**  
 Sale \$19.93 **Tool Club \$15.95**

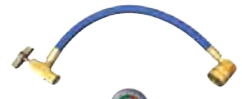

**FJC6037**  
**R-134a U-Charge Hose and Gauge for Self-sealing Valve Cans**  
 Sale \$31.23 **Tool Club \$24.99**



**FJC6845**  
**R-1234yf Charging Hose**  
 For R-1234yf self-sealing valve can tap.  
 Sale \$28.13 **Tool Club \$22.50**



**FJC2805YF**  
**R-1234yf Refrigerant Check Gauge**  
 Checks low-side operating pressure.  
 Sale \$31.19 **Tool Club \$24.95**



**FJC2805**  
**R-134a Refrigerant Check Gauge**  
 Checks low-side operating pressure.  
 Sale \$31.19 **Tool Club \$24.95**



**FJC6072YF**  
**R-1234yf Manifold/Hose Adapter Assortment**  
 Common adapter fittings for hoses on R-1234yf manifold gauge sets  
 Sale \$62.44 **Tool Club \$49.95**



**FJC2850**  
**Pro-Charge Electronic Scale**  
 H.D. die-cast aluminum refrigerant scale. 175 lb capacity. Accurate to +/- 1/2oz. or 0.5% of total weight.  
 Sale \$249.94 **Tool Club \$199.95**



**MSC98210A**  
**Electronic Scale**  
 Allows user to program desired quantities. Indicates amount of refrigerant left in tank. Allows user to know amount of refrigerant left in tank at any time.  
 Sale \$249.94 **Tool Club \$199.95**



**FJC2806**  
**Hand-Held Hydraulic Crimper Kit for A/C Hoses**  
 Quick-snap dies don't require pins or screws. Complete die set. For sizes: #6, #8, #10, #12 & reduced barrier hose sizes.  
 Sale \$474.94 **Tool Club \$379.95**



**MSC71550**  
**Manual Crimping Tool**  
 Sizes: 6, 8, 10, & 12. Dies snap quickly into place. Can be easily mounted to a bench or vise.  
 Sale \$299.94 **Tool Club \$239.95**



**RAAC1234-9**

**R-1234YF A/C Recovery Machine**

- Incorporated Wi-Fi & Bluetooth wireless technology.
- Huge 10.5" hi-res touch screen with easy-to-use controls.
- For use with automotive R-1234YF systems.
- Integrated refrigerant analyzer protects machine and vehicle system.
- Built-in training videos & speaker with web access for more training & A/C service info.

CALL FOR BEST PRICE

1234YF



**RAAC1234-6**

**R-1234YF Recover/Recycle/Recharge**

- Fully automatic operation.
- 98.5% recovery efficiency.
- Programmable vacuum operation.
- System leak test to identify gross leaks in a system.
- Charge accuracy within +/- 1/2 oz.
- Integrated refrigerant identifier.
- On-Board printer.

CALL FOR BEST PRICE



**RAAC1234-4**

**R-1234YF Recover/Recycle/Recharge**

- Does not come with printer

CALL FOR BEST PRICE



**RA34788NI**

**Premier R-134A Recovery/Recycle/Recharge**

- 98.5% recovery efficiency
- Refrigerant Identifier.
- Fully automatic.
- Newest addition to the fleet.

CALL FOR BEST PRICE

R134a

**RA34788NI-H**

**For Hybrid & NonHybrid Vehicles**

Does not use oil injection.

CALL FOR BEST PRICE

R134a

HYBRID



**MSS-ACX2180**

**ArcticPRO 134A RRR Machine**

- 7" touch screen.
- Used for 134A only.
- UV dye injector.
- Data management & reporting metrics.
- Best in class service & support.

CALL FOR BEST PRICE



NEW!

MAHLE

**MSS-ACX2280**

**ArcticPRO 1234YF RRR Machine**

- 7" touch screen.
- Used for 1234YF only.
- UV dye injector.
- Data management & reporting metrics.
- Best in class service & support.
- Integrated refrigerant identifier.
- Automatic oil management system.

CALL FOR BEST PRICE

**CPSMX3030**

**R-134a & R-1234yf**

**Refrigerant Management System**

This dual refrigerant unit provides full YF recovery, recycle, and recharge capabilities and can convert to an R-134a to service a sudden increase in demand or replace a non-working R-134a machine. 60" H x 27.5" W x 25 D. 115V & 850W. 220 lbs. capacity. Two 30lb recovery tanks.

CALL FOR BEST PRICE

NEW!



CPS Automotive

**CPSMX134A**

**R-134a Refrigerant Management System**

7" Color touch-screen control panel. WIFI Printer. Thermal Printer (Optional) Car health checks with the power of TAC100 (Bluetooth Wireless) Optional maximum load up to 220 lbs (100 kg). Refrigerant Management System monitors filter life and refrigerant usage.

CALL FOR BEST PRICE



**MSC69372**

**R134a/R1234yf**

**Complete A/C Recovery Set**

Approved for all A/C refrigerants including A2L & A3 flammable refrigerants. Built with the safest spark-free components. Includes all hoses and couplers needed to recover, cleanse and remove the oil from R134a and R1234yf automotive A/C systems as well as an extra filter dryer for replacement.

Sale \$2,249.94 **Tool Club \$1,799.95**

NEW!



**FJC9281YF**

**Vacuum Pump & Gauge Set - R-1234YF**

Includes R-1234yf aluminum manifold gauge set with anti-flutter design, manual couplers & adapters, & 72" hoses. Sparkproof 5.0 CFM Twin Port 1/3 HP vacuum pump.

Sale \$424.94 **Tool Club \$339.95**



**FJC9281**

**Vacuum Pump & Manifold Gauge Kit - R134A**

Includes brass manifold gauge set and 3.0 CFM twin port vacuum pump. Anti-flutter design gauges. Micron Rating: 75. 1/3 HP motor.

Sale \$249.94 **Tool Club \$199.95**



**RA34724**

**Recycling Filter-Driers**

Spin-on filter for Robinair 34788 machine.

Sale \$93.69 **Tool Club \$74.95**



**LANG13800**

**Digital Pocket Thermometer**

Measures -58°F to 572°F. Sale \$28.13 **Tool Club \$22.50**



**MSC52220**

**Pocket Analog Thermometer**

Measures 0 to 220° F. Sale \$9.94

**Tool Club \$7.95**



**MSC52223A**

**Dial Pocket Digital Thermometer**

Measures 58° to 302° F. Sale \$26.19 **Tool Club \$20.95**



TOP-TD52110063

**TOPDON Phoenix Elite Scan Tool**

- Connect to the newest vehicles & technology.
- 10.1" LCD Screen, 4-Core 2.0 GHz Processor & Android 10.
- All data in one view. Topology map granting a clear picture of related vehicle systems & status.
- Clearly defined CAN network layout. Diagnose communication issues in one glance.
- Step-by-step guided diagnostics process, based on code, for VAG Vehicles.
- Expand coverage to include ADAS Calibrations by upgrading your tablet.
- The Pre-Scan & Post Scan feature allows the technician the ability to record the codes prior to repair. This allows submission the customer or insurance company for repair approval.
- Vehicle Auto VIN & Autodetect
- Automatically capture the vehicles VIN number & determine all relevant information to auto populate the vehicle.

Sale \$5,625.00 **Tool Club \$4,500.00**



**H.D./TRUCK DIAGNOSTIC SCANNERS**

ATLMS909CV

**H.D. Scan Tool Kit**

- Compatible with over 80 light, medium, and heavy duty commercial vehicles.
- 9.7" Wireless Android-based touchscreen diagnostics tablet.
- Octa-core Processor with 128GB of Internal Storage.
- Wireless Vehicle Communication Interface (VCI).
- J2534 Passthru Programming Device.
- Topology Module Mapping, Guided Repair, Detailed Repair information including TSB and OE Campaigns.
- Performs Starting and Charging Systems Analysis with included MaxiBAS B200 tester with alligator clamps.
- Includes Multimeter & Amp Clamp.
- ADAS Calibration Software for Class 3-5 vehicles and Class 6 to 8 Vehicles with Dynamically Calibrated Systems.
- Rapid Vehicle Identification via VINscan and AutoVin.
- Includes One Year Limited Warranty and Free Software Updates

Sale \$5,743.75 **Tool Club \$4,595.00**

**AUTEL**



**CANDO-HDCODEII HD Code II Heavy Duty Code Reader**



- Covers Class4-8 HD Trucks
- Access Engine, Transmission & Brakes
- Automatic protocol search
- Capabilities for Caterpillar, International, Hino, Isuzu and Hybrid HD trucks
- Read & clear DTCs
- Special tests include: I/M Readiness, MIL Status, O2 Sensor Test, On-Board Monitor Test and EVAP System Test.
- Easy-to-read Large Screen

Sale \$474.94 **Tool Club \$379.95**



**ATLMS906CV MaxiSys MS906CV**

- 8" LED touch screen with Android
- 32GB solid state drive
- Rechargeable li-ion battery
- Coverage for 80+ vehicles
- Smart AutoVIN technology
- Instant remote control tech support
- Automatic software updates
- Code, live data, active test, etc.

Sale \$1,749.94 **Tool Club \$1,399.95**



**AUTEL**

ATLAL529HD

**AutoLink HD Code Reader w/ Deutsch-9 and Deutsch-6 Adapters For Heavy Duty Vehicles**

**AUTEL**

- Compatible with H.D. Vehicles utilizing SAE-J1939 and SAE-J1708 protocols
- Compatible with Domestic, Asian and European vehicles
- AutoVIN function for quick manufacturer-specific code identification
- Reads enhanced codes in Powertrain system for Ford, GM & Chrysler
- Enhanced OBDII Mode 6 access
- Reads, stores & plays back live sensor data.

Sale \$187.44 **Tool Club \$149.95**



**ATLOTOWATCHBV OTOFIX Smart Watch with VCI - Black ATLOTOWATCHHW OTOFIX Smart Watch with VCI - White**

- Wearable smart key that does everything your vehicle's smart key does.
- Performs smart key functions including Lock, Unlock, and Remote Start when programmed to vehicle.
- Comes with VCI to program Smart Watch to the vehicle & use smart key functions.
- Make and receive calls and texts when paired with a phone (iOS and Android).
- Health monitoring and reminder apps inc. sleep, heart rate, pulse oxygen, stand and breathe.
- More than 12 exercise and sports apps inc. running, walking, hiking, yoga, cycling – 45 mm high-definition touchscreen, white case, and band.
- Voice Control: Tell Watch to Remotely Start Car, Lock, Unlock Doors and Trunk.
- Free Autel Link app tracks health and exercise history.



**NEW!**

Sale \$374.94 **Tool Club \$299.95**

**LAUNCH TECH USA**

**LCH301050231  
CRP 123 Premium**

Tests four major systems, Engine, Transmission, Airbag (SRS) and Anti-lock Brake System (ABS). Now it Features an upgraded larger TFT color screen to the latest software are done through a PC with a USB cable. Reads the real-time live data streams. Shows I/M Readiness, MIL Status, VIN Info Evap systems Test.  
Sale \$249.94 **Tool Club \$199.95**



**ATLAL329**

**Autolink CAN OBDII  
Code Reader/Scan Tool**

Works on ALL 1996+ domestic and import vehicles (OBD II & CAN).  
Sale \$74.94 **Tool Club \$59.95**



**ATLMD808PRO**

**MaxiDiag MD808 Pro**

Support read / clear codes and live data functions for ALL systems.  
Test BMS / Oil Reset / SRS / EPB / DPF.  
Oil service reset.  
Battery registration and reset.  
Diesel particulate service.  
Reset service mileage and service intervals.  
Reset SAS functionality.  
Relearn parking brake pad.  
All OBDII protocols.  
Sale \$399.94 **Tool Club \$319.95**



**ATLMF2534**

**MaxiFlash Pro - J2534**

Fully compatible with both SAE J2534-1 and J2534-2 reprogramming standards. Performs the standard PassThru J2534 functionality. Compatible with Toyota Techstream, Volvo VIDA, Honda HDS, Jaguar, Land Rover IDS and BMW 3G for OEM diagnostics  
Sale \$1,249.94 **Tool Club \$999.95**



**ATLMFVCM1**

**MaxiFLASH VCM1**

Built-In 4 channel Oscilloscope, Multimeter, Signal Generator, and OBD Bus Check Functions. Supports D-PDU, RP1210, CANFD. J2534 & DoIP protocols.  
Sale \$1,624.94 **Tool Club \$1,299.95**



**ATLKM100**

**MaxiIM Universal Key Generator Kit**

An advanced key and immobilizer touchscreen tablet capable of smart key creation and IMMO learning via OBD. This 5.5-inch, Android touchscreen tablet with Bluetooth VCI can program the Autel IKEY as a smart key replacement for more than 700 vehicles and offers IMMO programming capability for multiple vehicle brands including BMW, Volkswagen, Toyota, Honda, and General Motors. 60 second key generation (Autel Universal Only). Transponder Reading/Writing/Cloning. Frequency detection & ignition coil detection. Key Renewal: supporting 36 vehicle makes. Transponder Editing: Supporting 20 categories. Dual-Band, High Frequency Transmitter 315m/434m or 868m/915m supporting certification requirements of various regions. Supporting PLC V200.  
Sale \$624.94 **Tool Club \$499.95**

**ATLMX808**

**MaxiCheck MX808**

- Read / clear codes for all available systems.
  - Display live data in text, graph, & analog.
  - Relearn parking brake pad after replacement.
  - Support IMMO functions and forced DPF regeneration and adjusting injectors.
  - Reset SAS and service mileage and service intervals.
  - Support TPMS sensor relearn.
  - Support battery registration & reset.
- Sale \$537.44 **Tool Club \$429.95**



**TOP-AD800BT**

**Wireless Bluetooth Mid-Level  
Diagnostic Scan Tool**

- Engine, Transmission, Airbag, ABS, ESP, TPMS, Immobilizer, Gateway, Steering, Radio, Air Conditioning, etc.
  - This OBD2 scanner uses AutoVIN technology
  - Oil light reset, Throttle matching, SAS calibration, DPF reset for diesel engine and many other maintenance services, brands covered are continuously updated.
- Sale \$511.25 **Tool Club \$409.00**



**TOPDON**



**KEY PROGRAMMER AUTEL**

**ATLIM508**

**MaxiIM IM508**

- XP200 Key & Chip Programming (read/write)
  - EEPROM / MCU Read / Write
  - Read PIN / CS (All Key Lost)
  - Key Generation
  - Key Learning / Remote Learning
  - Backup / Restore IMMO data
  - IMMO ECU Reset / Adaptation / Refresh / Coding
  - VW, AUDI MQB Key Learning, 48 Transponder (96-Bit) Add Key, All Key Lost, A6 All Key Lost
- Sale \$1,249.94 **Tool Club \$999.95**



**ATLIM608PROKPA**

**MaxiIM IM608PROKPA**

- Powerful combination of advanced key programming/all systems diagnostics/ advanced maintenance services
  - Professional key programming equipped with XP400 key programmer & MaxiFlash
  - ECU programmer for complete Immo coverage
  - Smart mode for guided & automated key learning
  - Expert mode for advanced key learning
  - Read PIN/CS (all key lost), generate key, key learning, remote learning
  - IMMO ECU reset/adaptation, refresh/coding
  - Read/write transponder data, ECU/MCU/EEPROM data (eg. 9S12 encryption chip), IC card, detect remote frequency
  - Powerful OE level diagnostics for more than 80 US, Asian and European makes and models
  - All special functions, EPB, DPF, SAS, Oil reset, BMS, TPMS sensor ID relearn, etc.
  - 10.1-inch LED capacitive touch screen with 64GB On-Board Memory
- Sale \$3,999.94 **Tool Club \$3,199.95**



**AUTEL**







# AUTEL®

**DIAGNOSTICS**

## ATLMSULTRA

### MaxiSYS ULTRA with MaxiFLASH VCMi

- Features a 13" touchscreen tablet with Android 7.0 OS
- Powered by an Octa-core processor (2.3GHz Quad + 1.7GHz Quad)
- Substantial 256GB built-in memory
- Combined with the dynamic topology module mapping, enhanced AutoSCAN features and Intelligent Diagnostics options, the Ultra offers the technicians step-by-step repair guidance.
- The new MaxiFlash VCMi functions as a 4-channel oscilloscope, waveform generator, multimeter, and CAN BUS tester.
- The convenient docking station featured ensures you always have the power to scan.
- Autel updates provide latest OE level coverage for more than 80 US Domestic, Asian and European vehicles, including supercar.
- One-stop multitasking designed for ideal management of workshop operations to keep all data files, customer info, and vehicle records well organized
- Includes 1 year warranty / 1 year FREE software updates



5-IN-1 VCMi

**Sale \$6,249.94 Tool Club \$4,999.<sup>95</sup>**

## ATLMS909

### MaxiSYS MS909 with MaxiFLASH VCI

- Features a 9.7" touchscreen tablet with Android 7.0 OS
- Powered by an Octa-core processor (2.3GHz Quad + 1.7GHz Quad)
- Substantial 128GB built-in memory
- Features vehicle diagnostics for passenger/light duty vehicles
- Basic & special functions for US, Asian & European vehicles 1996 & newer
- OBDII Test Modes live & freeze frame/enhanced mode 6
- 26 service reset features
- Resets diesel emissions on light & medium duty vehicles
- Bi-directional control & advanced coding & adaptations
- Covers all domestic, Asian and European vehicle manufacturers (1996 to present).
- TPMS antenna triggers all known sensors / clone and program Autel MX-Sensors.
- Oil service reset, TPMS relearn, EPB, ABS/ SRS, SAS.
- Includes 1 year warranty / 1 year FREE software updates



**Sale \$4,062.44 Tool Club \$3,249.<sup>95</sup>**

## ATLMS906PRO-TS

### MaxiSYS MS906Pro-TS with Bluetooth VCI

- Features an 8" touchscreen tablet with Android 10.0 OS
- Powered by a Qualcomm 660 Octa-Core Processor
- Substantial 128GB built-in memory
- MaxiVCI V200 wireless Bluetooth vehicle communication interface supporting the latest communication protocols
- Comprehensive diagnostics on 1996 & newer U.S., Asian & European vehicles
- Scan all available systems, including ADAS identification
- Read/Erase codes, view freeze frame & live data
- Perform active tests (bi-directional controls), coding & adaptations
- AutoVIN/Scan VIN for rapid vehicle identification
- Performs ADAS Calibrations with software upgrade & frame system purchase
- Comprehensive TPMS service, including the ability to activate & relearn all known sensors, & program the Autel 1-Sensor to replace 99% of TPMS sensors on the road today



**NEW!**

**Sale \$2,474.94 Tool Club \$1,979.<sup>95</sup>**

## ATLMS906PRO

### MaxiSYS MS906Pro

- Features an 8" touchscreen tablet with Android 10.0 OS
- Powered by a Qualcomm 660 Octa-Core Processor.
- Substantial 128GB built-in memory
- MaxiVCI V200 wireless Bluetooth vehicle communication interface supporting the latest communication protocols
- Comprehensive diagnostics on 1996 & newer U.S., Asian & European vehicles
- Scan all available systems, including ADAS identification
- Read/Erase codes, view freeze frame & live data
- Perform Active Tests (bi-directional controls), Coding & adaptations
- AutoVIN/Scan VIN for rapid vehicle identification
- Perform ADAS Systems calibrations with additional purchase.



**NEW!**

**Sale \$1,937.44 Tool Club \$1,549.<sup>95</sup>**

**LOCK OUT TOOLS**



**LT1000**  
**Supreme Master Automotive Lock Out Kit**  
 18pc kit. Everything you need to handle emergency lock outs.  
 Sale \$237.44 **Tool Club \$189.95**



**LT130**  
**Easy Access Door Unlocking Kit**  
 Easily opens most vehicles without entering the door panel. Includes 54" fluorescent green, easy access door unlocking tool, 2 plastic door wedges, plastic slip jim, & Inflate-A-Wedge.  
 Sale \$82.44 **Tool Club \$65.95**



**LT140**  
**2pc Inflate-A-Wedge™ Kit**  
 Features a 53" rigid tool, a slim jim, two plastic wedges, plus an inflatable wedge.  
 Sale \$78.13 **Tool Club \$62.50**



**LT275**  
**Inflate-A-Wedge™**  
 Will safely wedge the door without damage.  
 Sale \$45.31 **Tool Club \$36.25**



**TA1500**  
**24" Door Unlocking Tool**  
 For vehicles having lock mechanisms accessible via the opening between the top of the door and the window glass.  
 Sale \$11.88 **Tool Club \$9.50**



**ACC-ERK**  
**Emergency Response Kit**  
 Designed by first responders. Emergency ready. Most popular accessories. Gets into any vehicle.  
 Sale \$168.69 **Tool Club \$134.95**



**ACC-OHJS4**  
**One Hand Jack Set**  
 Designed for all vehicles. Comes with quick DVD. Store-N-Go handle. Scratch-proof coating.  
 Sale \$90.63 **Tool Club \$72.50**

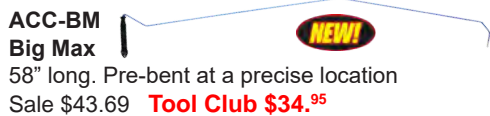

**ACC-BM**  
**Big Max**  
 58" long. Pre-bent at a precise location  
 Sale \$43.69 **Tool Club \$34.95**



**ACC-SAW**  
**Super Air Wedge**  
 Won't damage the vehicle. Perfect for medium size vehicles to SUV's & trucks.  
 Sale \$48.13 **Tool Club \$38.50**



**ACC-ULRK**  
**Ultimate Long Reach Kit**  
 Most popular tools and comprehensive kit. Easy to transport. Perfect for beginners & pros!  
 Sale \$298.13 **Tool Club \$238.50**

**KEY CUTTING & PROGRAMMER**

**XTO-NITRO-XT-SYS**

**Master Key Making System**  
 This Complete Key Making System comes with everything you need to stock, build and program keys.  
 • Covers over 80% of the North American market.  
 • The key making process can be explained in 3 easy steps.  
 • Identify the Correct Product Go to nitrouskeys.com.  
 • Pick the desired remote from your Nitrous Keys remote bundle or MFK set.  
 • Cut the Key Blade Use the Triton Key Cutting Machine to decode and duplicate the existing key.  
 • Nitro XT Diagnostic Scan Tool (XTU-NITRO-XT)  
 • Triton Key Cutting Machine (XTU-TRM1)  
 • Nitrous Keys Remotes - Complete Bundle for remote fobs, remote head keys and proximity smart keys (XTU-27301238)  
 • Nitrous Keys Full MFK Set Includes Heads, Blades and Chips for building transponder keys (XTU-27801294)  
 Sale \$12,000.00 **Tool Club \$9,600.00**



**XTO-27801294**  
**Nitrous Keys Full MFK Set (Heads, Blades & Chips)**

• One single kit will provide the flexibility to create hundreds of mechanical keys in 24 of the most common keyways  
 • Combine it with MFK Heads and a handful of chips and now you've got the power to create TONS of different transponder keys  
 • Use as TEST KEYS : Using the reusable, blue universal head, cut these inexpensive blades and test in the lock before duplicating onto a more expensive transponder key or remote head key  
 Sale \$955.31 **Tool Club \$764.25**



**XTO-20201002**  
**Key Making System**

• Cuts 99% of contemporary automotive keys, right out of the box!  
 • Brand-new, completely overhauled direct-drive motor  
 • Integrated, proprietary key code database supports key cutting directly by code for most automotive keys, streamlining your workflow and eliminating the need to reference other code sources.  
 • Comprehensive database of automotive, commercial & residential keys & can even generate dimple-cut keys.  
 • Unlimited, free updates for the life of your machine via Wi-Fi.  
 Sale \$5,368.75 **Tool Club \$4,295.00**



# EPHY'S INDEX

ADJUSTABLE WRENCHES	42,43	FLARING TOOLS	103	PULLERS	71,78,79,82
AIR ACCESSORIES	26,27,28	FLARENUT WRENCHES	4	PUMPS AND RAMS	86,87
AIR COMPRESSORS	29	FLASHLIGHTS	23,24,25	PUNCHES	65
AIR COOLERS	26	FLOOR JACKS	59,60	RADIATOR TOOLS	94,95
AIR CONDITIONING	116,117,118	FLOOR JACKS	59,60	RELAY TESTERS	108
AIR TOOLS	30,31,32,33,34	FLUID EVACUATORS	96,98	RIVET TOOLS	89
ALLEN/HEX KEYS	14,15,16	FILES	66	SAFETY / PPE	52
AXLE JACKS	60	FRONT END	34,70	SANDERS AND POLISHERS	32,88,91,90
AXLE SOCKETS	17,68	FUEL INJECTION	69	SCAN TOOLS	38,119,120,121,122
BALL JOINT	70	FUEL LOCK RING TOOLS	76	SCRAPERS	14,38,39,40
BATTERY CHARGERS	113	FUEL TRANSFER	96	SCREWDRIVERS	38,39
BATTERY TESTERS	112	FUNNELS	77,104	SENSOR TOOLS	78
BATTERY TOOLS	110-115	GLOVES	52	SERPENTINE BELT	81
BEARING / SEAL TOOLS	78	GOJACK	59	SHOP ASSORTMENTS	51,52,90,89
BEARING SPLITTERS	82	GREASE GUNS / PUMPS	96,97,104	SLACK ADJUSTERS	69,83
BENCH GRINDERS	63	HAMMERS	64,84	SLAP HAMMERS	82,85
BIT SETS	14,15,16,40	HARMONIC BALANCER	79	SMOKE MACHINES	50
BODY AIR TOOLS	32,33,90,91	HEAT GUNS	90	SNAP RING PLIERS	43
BODY CLIP SETS	85	HOOK AND PICK	38	SOLDERING	92
BODY HAMMERS	84	HOSE CLAMP PLIERS	94	SPANNER WRENCH	81
BODY SHOP TOOLS	84-92	IMPACT SOCKETS	17,18,19,20,21	SPARK PLUG TOOLS	46
BOOSTER CABLES	115	IMPACT ADAPTERS	21,40	SPINDLE NUT SOCKETS	17
BOOSTER PACS	114,115	IMPACT EXTENSIONS	21	SPRAY GUNS	88
BOROSCOPES	106	IMPACT TOOLS	30-37	STRUT TOOLS	71
BOTTLE JACKS	56,59	INSPECTION CAMERAS	106	TAP & DIE SETS	47
BRAKE SERVICE TOOLS	98,102,103	INSULATED TOOLS	44	TERMINAL TOOLS	106
BREAKER BARS	10	JACK STANDS	58	TEST LEADS	110
BUDD WHEELS	17	JUMP STARTERS	114,115	TEST LIGHTS	110
CAMSHAFT TOOLS	72,73,74	KEY PROGRAMMER	123	THERMAL IMAGING	106
CAR DOLLIES	59,91	LIFTING EQUIPMENT	56,57,58,59	THERMOMETERS	106
C-CLAMP	63	LIGHTING	23,24,25	THREAD REPAIR	46,47,48,49,50
CHISELS	65	LOCK OUT TOOLS	123	TIE ROD	83
CHROME ACCESSORIES	12,13	LUBRICATION	96-101	TIRE INFATORS	27,36
CHROME RATCHETS	9,10,11	LUG SOCKETS	17	TIRE REPAIR	67
CHROME SOCKET SETS	6,7,8	MAGNETS AND MIRRORS	41	TOOL BOXES / CARTS	54,55,62
COME ALONGS	84	MANIFOLD DRILL TEMPLATE	50	TOOL STORAGE	53
CORDLESS TOOLS	35,36,37	MEASURING TOOL	13	TORQUE WRENCHES	11
CREEPERS	61	MEMORY SAVERS	108	TORX	14,15,16
CRIMPERS	109	MILWAUKEE TOOLS	35,36,37,88,89	TPMS	105
CROWSFOOT	4	MO-CLAMP	84	TRANSMISSION JACKS	57
DAMAGED LUG REMOVERS	48,49	MULTIMETERS	107,111	TRIPLE SQUARE	14,15,16
DIAGNOSTIC	106-115, 118-122	OIL DRAINS	98,99	TRUCK JACKS AND STANDS	58,60
DIESEL PRESSURE TESTERS	76	OIL SERVICE TOOLS	98,99,100,101	TRUCK TOOLS	67,68,69
DISCONNECT TOOLS	97,100	OSCILLOSCOPE	111	UNDERHOIST STAND	57
DRILL BITS	48,49,50	PAINT GUNS	88	UNIBITS	49
DRILLS	36	PLIERS	42,44,45,94	VACUUMS	86
DRIVE LINE SOCKETS	22	PIPE WRENCHES	42	VALVE TOOLS	75
ELECTRIC TOOLS	44	POLISHERS	88	WISE	63
ENGINE LIFT EQUIPMENT	56	PORTO-POWERS	86,87	WISEGRIP	45
ENGINE TOOLS	71-81	POWER INVERTERS	112,115	WATER PUMP	81
EVACUATORS	98	POWER PROBE	107	WELDING	91,92,93
EXHAUST HOSE	83	POWER SUPPLY	112-115	WHEEL / TIRE TOOLS	67,105
EXTENSIONS	12	POWER TOOLS	35,36,37,88	WHEEL SOCKETS	17
EXTRACTORS	47,48,49	PRESSES	62	WINDSHIELD TOOLS	90
FAN CLUTCH	81	PRESSURE TESTERS	76,77	WRENCHES	3,4,5,6
		PRY BARS	66		

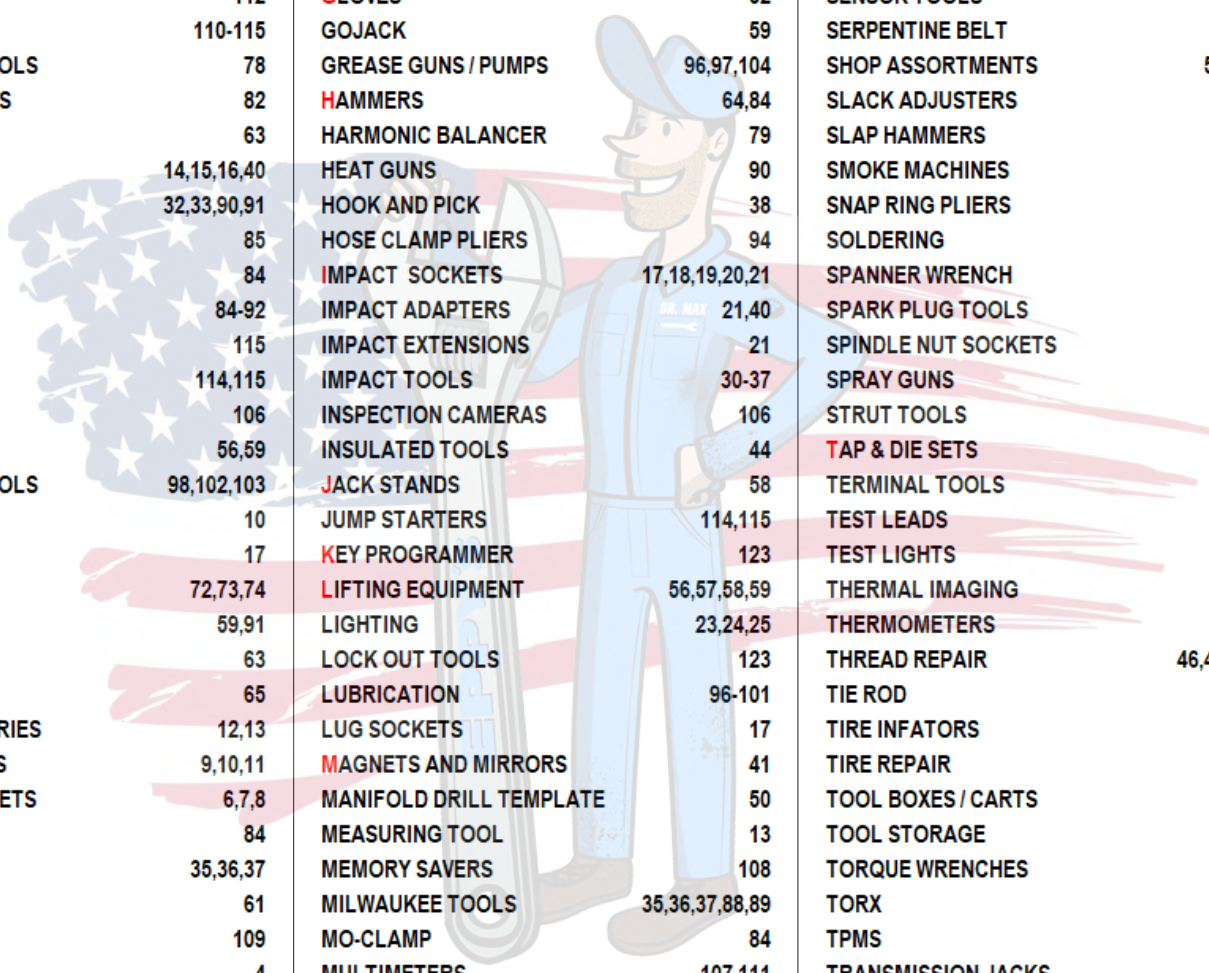

Eppy's Tool & Equipment Warehouse Inc.

809 E 42nd St  
Brooklyn, NY 11210  
718-434-7878  
www.eppys.com

2777 Rt 9 N  
Howell, NJ 07731  
732-942-3700  
sales@eppys.com



PRESORTED  
STANDARD  
U.S. Postage Paid  
Aberdeen, SD  
Permit #200

PRICES GOOD THROUGH MARCH 31, 2023

Due to the Ongoing Material Inflation Some Catalog Prices are Subject to Change before 3/31/2023. Shop at our NY/NJ showrooms! Eppy's offers a broad range of tools & equipment with over 100,000 quality products and quick local truck delivery! Some quantities limited. Not responsible for typographical errors.

# MECHANIC'S TOOL CLUB™



[www.eppys.com](http://www.eppys.com)



PG. 10



PG. 48



PG. 38



PG. 7



PG. 40



PG. 17



PG. 3



PG. 65



PG. 81